

WORKSPACE

Office Furniture in 48 Hours!

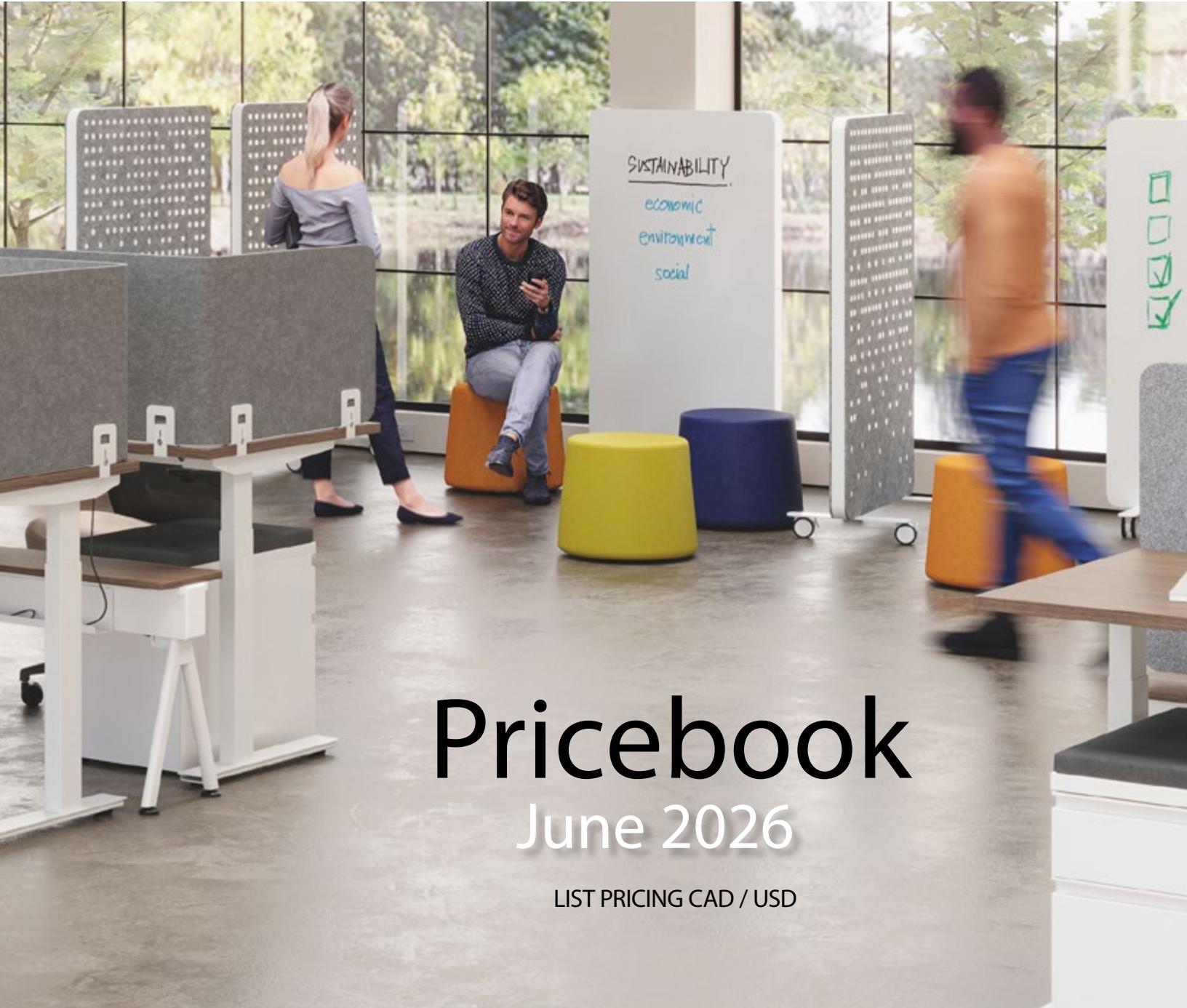

Pricebook

June 2026

LIST PRICING CAD / USD

Updated June 15, 2026

Our Mission



COMPANY OVERVIEW

- Lead Times 4
- Pricing 4
- Finishes 5
- Terms & Conditions 6-7
- Warranty..... 8-9

PRODUCTS

WORKSTATIONS

- HEIGHT ADJUSTABLE DESKS
 - Kinetic desks 12
- POWER/DATA BEAM
 - Electrical20
 - Array.....25
- BENCHING: HEIGHT ADJUSTABLE
 - Electrical20
 - Vibe benching.....30
- BENCHING: FIXED HEIGHT
 - Axis.....32
- WORKSURFACES42
- SOFT SEATING FOR LOUNGE/
PRIVACY/MEETINGS**
 - Motion®Office48

TABLE OF CONTENTS

- Contact Information..... 118
- Social channels..... 119
- SEATING**
 - All styles.....67
- TABLES**
 - Modulus.....78
 - Axis.....90
- STORAGE**
 - Milo metal storage.....96
 - Mochi undermount98
 - Overhead Hutch99
- RECEPTION**
 - Reception Counters..... 100
- PRIVACY & DECOR**
 - Versi screens 102
 - Viro planter wall..... 111
- ACCESSORIES**
 - Orbit Divider..... 115
 - Cable Management 116
 - Monitor arms 117

LEAD TIMES



Standard – Core Collection
In stock and ships in 48 hours!

All orders with products* in quantities under 50

*Noted size/finish exceptions below.

10 Day

Extended – Expanded Collection
More finishes, larger orders

All orders with products in quantities of 50 or more

Plus, select products (in any quantity):

1. Grey Elm and Continental Walnut worksurfaces (all sizes)
2. 54" and 66" wide worksurfaces (all finishes)
3. Array Premium Surface

Lead times start with order acknowledgment of a clean P.O.
Order acceptance cutoff is Noon EST.

Example:

Orders in before Noon EST on a Monday will ship Wednesday.
Orders in after Noon EST on a Monday will ship on Thursday.

PRICING

Pricing is List and landed – includes freight in the continental U.S. and Canada.^{1 2}

¹Freight charges apply for HI, AK and certain remote locations — contact customer care for details.

²Orders under \$1,500/net incur a \$150 freight surcharge.

Note we currently have a 5%/Net tariff offset fee on U.S. orders.

FINISHES

All available in 48 hours unless otherwise specified.

Metals

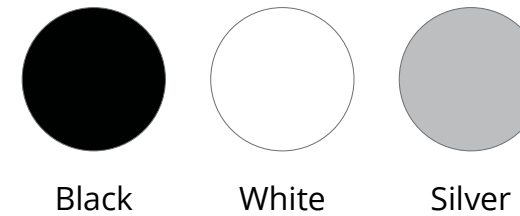

Laminates

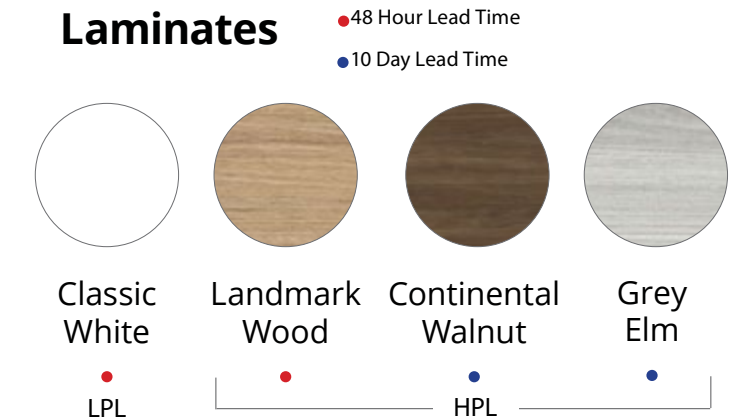

Ripple Collection (Versi/Mochi PET) and Plush Collection (Milo/Motion® felt)



Additional Plush (for Motion® only):



Terms & Conditions

1. These terms and conditions shall apply to all sales of goods by Workspace48 Inc. No variation of any of these conditions shall be binding unless expressly agreed to by Workspace48 Inc. in writing.
2. All prices are exclusive of GST/HST unless otherwise stated.
3. All orders under \$1,500/net will be subject to a \$150 freight charge.
4. Payment in full shall be made to Workspace48 Inc. net 30 days on invoice. All orders over \$50,000 require a 35% deposit. Container payment terms are 30% deposit with order, 70% upon arrival of product. Workspace48 Inc. reserves the right to demand payment before that date or in advance and further reserves the right to specify in any quotation a requirement for a deposit to be paid before work shall commence. Interest shall be payable to Workspace48 Inc. on the Customer's overdue accounts at the rate of 18% per annum calculated on a daily basis to run from the due date for payment until receipt by Workspace48 Inc. of the full amount payable. The Customer shall pay all costs including any legal costs incurred in recovering overdue accounts.
5. We may suspend or terminate this agreement if at any time we consider the Customer's credit worthiness to be unsatisfactory for any reason or if the Customer is in default of any of its payment or other obligations hereunder. We shall not be responsible under any circumstances for any loss, damages, costs or expenses whatsoever caused in any way by the suspension or termination under this clause.
6. Goods returned for credit will only be accepted subject to Workspace48 Inc.'s prior agreement in writing with all freight charges prepaid by the Customer. Returned goods, if accepted by Workspace48 Inc., are subject to a minimum restocking fee of the greater of \$75 or 20% of the invoice price. Returned product will not be accepted if it has been removed from its original packaging and no credit will be issued for product returned damaged.
7. Prices are subject to variation without notice, and goods and services will be invoiced at prices current at the time of their provision unless otherwise agreed in writing.
8. Sales tax and any other taxes or duty on or in respect of the goods sold by Workspace48 Inc. imposed by any Provincial or Federal Government law shall be payable by the Customer, but if those taxes or duties by law are or become payable by Workspace48 Inc., the prices in respect of the goods shall be increased by the amount necessary to ensure that the net amount actually received by Workspace48 Inc. is as if those taxes or duties were not payable.
9. If the Customer is a limited liability company or a trust, then the director(s) and shareholder(s) of the company or the trustee(s) of the trust (as the case requires), hereby guarantee the performance of the Customer's obligations under this agreement and are personally liable to meet the Customer's obligations under this agreement in the event of the Customer's default. Those director(s) and shareholder(s) or trustee(s) also agree to indemnify Workspace48 Inc. and hold Workspace48 Inc. harmless for any losses Workspace48 Inc. sustains as a result of the Customer's act or omission. A director, shareholder or trustee (as the case requires) must reimburse Workspace48 Inc. for all its losses caused by the Customer's act or omission within 21 days of Workspace Inc. making a demand for such reimbursement (time being of the essence). Any director, shareholder or trustee signing this agreement on behalf of the Customer also signs in a personal capacity for the purposes of the guarantee and indemnity contained in this clause.
10. The Customer warrants that such plans, specifications, measurements or information that have been supplied by the Customer at the time of commencing work on purpose built furniture are correct and can be relied upon. Once work has started the Customer may not vary or withdraw from this or any other agreement with Workspace48 Inc. unless with Workspace48 Inc.'s agreement in writing.
11. All warranties conditions and representations whether express or implied other than any express warranty stated by Workspace48 Inc. in writing are hereby expressly negated and excluded except in circumstances where Workspace48 Inc. is by law unable to exclude or limit its liability. Provided that where the Customer is a consumer for the purpose of the Trade Practices Act, but the goods or services are not of a kind ordinarily required for personal domestic or household use or consumption, the liability of Workspace48 Inc. shall be limited as determined by Workspace48 Inc. to the following:
 - a. The replacement of the goods or the supply of equivalent goods
 - b. The payment of the freight costs to replace the goods or equivalent goods
12. No claim of any nature whatsoever (other than relating to warranty) will be recognised unless made within 24 hours of delivery. All freight costs involved in returning goods must be paid by the Customer. A copy of the invoice evidencing sale to the Customer is to be included with the goods, and include photo's to clearly identify the issue concerned.
13. Subject to everything in these conditions Workspace48 Inc. makes no further condition, warranty or representation, whether express or implied, written or oral in respect of the goods or services.
14. Notwithstanding anything above Workspace48 Inc. shall not be liable for any consequential or indirect losses expenses or damages suffered by the Customer in consequence of any defect in materials or workmanship of the goods.
15. Claims for errors, short supply, or for goods arriving in a damaged condition shall be made within seven (7) days of the date of invoice, and the Customer shall refuse to sign any deliver docket where goods arrive in a damaged condition. Workspace48 Inc. must be notified of the claim within 24 hours and assigned a file number by Workspace48 Inc. or the claim will not be accepted. The Customer is deemed to have accepted the goods unless it makes a claim under this clause. The Customer acknowledges that a signed delivery docket signifies acceptance that the goods arrived in an undamaged state and Workspace48 Inc. shall not be liable to repair any damage in such cases. The Customer is responsible to file any claim resulting from Customers' carrier.
16. Risk in goods supplied under this agreement passes to the Customer upon delivery to the Customer or its agent or upon possession of the goods by the Customer or its agent, whichever is the earlier.
17. Workspace48 Inc. shall not be liable in any way whatsoever for any failure to deliver any order on time or for non-delivery or delay caused directly or indirectly by war, act of God, strike, lockout, riot, Government action or interference, fire, earthquake, material, shortage, late delivery by manufacturers, shipping or transport delay or any other cause beyond the reasonable control of Workspace48 Inc. The Customer shall be bound to accept and pay for goods delivered within a reasonable time after such cause for the failure or delay on the part of Workspace48 Inc. has ceased to operate.
18. To the fullest extent possible, ownership of any goods supplied by Workspace48 Inc. is retained by Workspace48 Inc. until payment in full is made for the goods supplied and for all other goods supplied by Workspace48 Inc. to the Customer. This clause creates a security interest under the Personal Property Securities Act 2009 in favour of Workspace48 Inc. in all present and after-acquired property supplied by Workspace48 Inc. to the Customer. Customers waive the right to be notified in writing of registration on the Personal Property Securities Register.
19. Workspace48 Inc., its servants or its agents may immediately without giving the Customer any notice or waiting any time, retake possession of the goods supplied or any other goods supplied by Workspace48 Inc. under any other arrangement under which title in those goods is still maintained by Workspace48 Inc.
20. The Customer gives Workspace48 Inc. authority for its servants and agents to enter and remain upon any land or premises where in Workspace48 Inc.'s opinion Workspace48 Inc.'s goods may be stored and take possession of the said goods.
21. Under no circumstances shall Workspace48 Inc. be liable for any damage, costs, losses or expenses arising on or resulting from such repossession.
22. The Customer shall hold the proceeds of sales of our goods arising in the normal course of trade, upon trust for Workspace48 Inc. and shall promptly account to Workspace48 Inc. for such proceeds or the amount of them necessary to pay all amounts due to Workspace48 Inc.
23. The failure on the part of Workspace48 Inc. to exercise and enforce any rights conferred by this agreement shall not be deemed to be a waiver of any such right nor operate so as to bar the exercise or enforcement thereof at any time or times thereafter.
24. All freight charges are as described in your company specific discount structure, unless otherwise specified on a project specific quotation.
25. Upon receipt of an approved credit application, orders can be placed in the following way; Phone: 416 441 9898; Email: Orders@workspace48.com. Phone orders are required to have final confirmation in writing. All orders will be acknowledged by email as final confirmation of your order, including net pricing and quantities. If in the unlikely event of low stock, you will be notified and alternative solutions advised.
26. In-stock items can be cancelled by the Customer in writing prior to dispatch, without any cancellation charge. Orders cancelled after shipping and before arrival to the Customer will be subject to a minimum handling fee of \$75 plus any applicable direct costs, payable by the Customer. Any custom built products are not able to be cancelled once the order has been acknowledged and entered into production.

Warranty



10 Years, across the board*.

Includes 8 hours of daily standard use by purchasing company (not applicable if rented or resold).

All Workspace48 products are durable for long-term performance and value. Our products have been rigorously tested to the equivalent of 10 years average use, and our processes comply with internationally recognized certifications. We know the peace of mind a warranty like this can give when making a purchase. If you need to know any information about the legal terms of your warranty, you can find everything right here, or simply give one of our friendly account managers a call.

*See Warranty Limitations, next page.

Warranty

Workspace48 promises the original purchaser that it will repair or replace with the comparable product, at its option and free of charge (for material and components) any product, part or component which fails under normal use over the duration of specified warranty term (taken from the date of purchase).

Normal commercial usage is defined as the equivalent of a single shift, 40-hour work week.

A Customer who requests services under this warranty must comply with directions from Workspace48 staff if the warranty claim is to be investigated, and if Workspace48 is to provide repairs and/or spare parts and/or replacement solutions (where applicable). The Customer will usually be required to provide a detailed description of the warranty service they are requesting, accompanied by any relevant photos or videos.

If the Customer does not comply with the directions aforementioned, Workspace48 is not required to provide services in accordance with this warranty. Without the description and images, Workspace48 can neither investigate the claim nor provide an appropriate solution.

Goods purchased from Workspace48 are covered by guarantees that cannot be excluded under Canadian Consumer Law. The Customer is entitled to a replacement or refund in a case of major fault.

Minor variations in dimensions, color, grain, or finish in Goods received by a Customer, when compared with images or descriptions on the Website, are not covered by this Warranty. The Warranty does not cover damage that affects only packaging.

Warranty Limitations

The particular product lines, materials and components listed below are covered according to the following schedule from the date of sale:

- Five Years - Luna Chairs, Electric motors, workstation electrical components, Array Accessories

Warranty Exclusions

This warranty does not apply, and no other warranty applies to:

- Products that were not installed, used, or maintained in accordance with Workspace48 instructions
- Products that have been disassembled, modified, or rebuilt
- Normal wear and tear, which is to be expected over the course of ownership
- High-wear items such as glides and textiles
- Abuse, misuse, or accident
- Alteration or modification of the product including substitution of Workspace48 components with any unauthorized non-Workspace48 components
- Products considered consumables, Customer's Own Material (COM) or non-standard textiles and materials
- Variations occurring in surface materials (e.g., color-fastness or matching grains, textures, and colors across dissimilar lots)
- Products used for rental purposes

To the extent allowed by law, Workspace48 makes no other warranty, either express or implied, including any warranty of merchantability or fitness for a particular purpose. Workspace48 will not be liable for any consequential or incidental damages.



Workstations

HEIGHT ADJUSTABLE DESKS

- Kinetic
- Frames only..... 12
- with Worksurfaces..... 13-18
- Accessories..... 19

- Array power/data beam
- Electrical.....20
- Array.....25

HEIGHT ADJUSTABLE BENCHING

- Vibe
- Electrical.....20
- Vibe benching.....30

FIXED HEIGHT BENCHING



- Axis
- Overview.....32
- Desking.....34
- Electrical & Accessories.....40
- Axis Screens.....41

WORKSURFACES

- Linear..... 42
- 90° and 120°..... 46
- Round..... 47

Kinetic height adjustable base - Frames Only

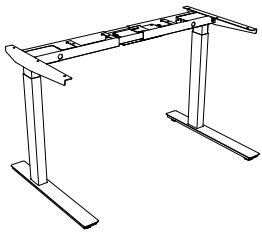
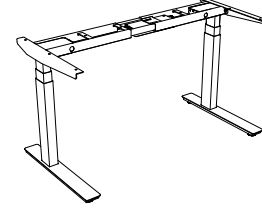
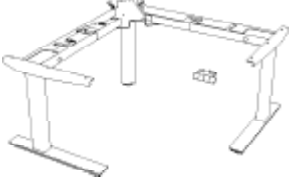
Frames only

Product	Description	Worksurface	Code	CAD	USD
	Kinetic height adjustable base, frame 2-Stage C leg with 22" feet	Fits 48/54/60/66/72 W x 24 D	KN2S24/#F	\$1,310	\$975
	Kinetic height adjustable base, frame 2-Stage C leg with 28" feet	Fits 48/54/60/66/72 W x 30 D	KN2S30/#F	\$1,335	\$995
	Kinetic height adjustable base, frame 3-Stage C leg with 22" feet	Fits 48/54/60/66/72 W x 24 D	KN3S24/#F	\$1,425	1,065
	Kinetic height adjustable base, frame 3-Stage C leg with 28" feet	Fits 48/54/60/66/72 W x 30 D	KN3S30/#F	\$1,450	\$1,080
	Kinetic height adjustable base, 3-legged frame 90 degree, 3-Stage leg for 24" deep worksurfaces	Fits main surface: 54/60/66/72 W x 24 Return: 24/36/42/48 x 24/30	KN3S3L24/#F	\$1,910	\$1,625
	Kinetic height adjustable base, 3-legged frame 90 degree, 3-Stage leg for 30" deep worksurfaces	Fits main surface: 54/60/66/72 W x 30 Return: 24/36/42/48 x 24/30	KN3S3L30/#F	\$1,930	\$1,645
	Kinetic height adjustable base, 3-legged frame 120 degree, 3-Stage leg for 24" deep worksurfaces	Fits 48 x 48 x 24	KN3S3L120/#F	\$1,910	\$1,625
	Available January 2026				

/#F - Select finish

Powdercoat **B** **W** **S**

Kinetic height adjustable Desks - 2 Stage

Full Assemblies - with Worksurfaces

Product	Description	Dimensions	Code	CAD	USD
	Kinetic height adjustable desk 2-Stage leg, Singlesided Classic White LPL Worksurface Specify Black, White or Silver frame	48 x 24	KN2S4824/#300	\$1,435	\$1,105
	Kinetic height adjustable desk 2-Stage leg, Singlesided Woodgrain HPL Worksurface Specify Black, White or Silver frame		KN2S4824/####	\$1,540	\$1,170
	Kinetic height adjustable desk 2-Stage leg, Singlesided Classic White LPL Worksurface Specify Black, White or Silver frame	48 x 30	KN2S4830/#300	\$1,495	\$1,155
	Kinetic height adjustable desk 2-Stage leg, Singlesided Woodgrain HPL Worksurface Specify Black, White or Silver frame		KN2S4830/####	\$1,635	\$1,245
	Kinetic height adjustable desk 2-Stage leg, Singlesided Classic White LPL Worksurface Specify Black, White or Silver frame	54 x 24	KN2S5424/#300	\$1,475	\$1,135
	Kinetic height adjustable desk 2-Stage leg, Singlesided Woodgrain HPL Worksurface Specify Black, White or Silver frame		KN2S5424/####	\$1,635	\$1,225
	Kinetic height adjustable desk 2-Stage leg, Singlesided Classic White LPL Worksurface Specify Black, White or Silver frame	54 x 30	KN2S5430/#300	\$1,550	\$1,205
	Kinetic height adjustable desk 2-Stage leg, Singlesided Woodgrain HPL Worksurface Specify Black, White or Silver frame		KN2S5430/####	\$1,715	\$1,315

Dimensions are nominal. 54" and 66" worksurfaces are on a 10-Day lead time
PCV edge banding is 2mm.

Kinetic height adjustable desks - 2 Stage

Full Assemblies - with Worksurfaces

Product	Description	Dimensions	Code	CAD	USD
	Kinetic height adjustable desk 2-Stage leg, Singlesided Classic White LPL Worksurface Specify Black, White or Silver frame	60 x 24	KN2S6024/#300	\$1,475	\$1,135
	Kinetic height adjustable desk 2-Stage leg, Singlesided Woodgrain HPL Worksurface Specify Black, White or Silver frame		KN2S6024/####	\$1,610	\$1,225
	Kinetic height adjustable desk 2-Stage leg, Singlesided Classic White LPL Worksurface Specify Black, White or Silver frame	60 x 30	KN2S6030/#300	\$1,550	\$1,205
	Kinetic height adjustable desk 2-Stage leg, Singlesided Woodgrain HPL Worksurface Specify Black, White or Silver frame		KN2S6030/####	\$1,715	\$1,315
	Kinetic height adjustable desk 2-Stage leg, Singlesided Classic White LPL Worksurface Specify Black, White or Silver frame	66 x 24	KN2S6624/#300	\$1,520	\$1,180
	Kinetic height adjustable desk 2-Stage leg, Singlesided Woodgrain HPL Worksurface Specify Black, White or Silver frame		KN2S6624/####	\$1,645	\$1,260
	Kinetic height adjustable desk 2-Stage leg, Singlesided Classic White LPL Worksurface Specify Black, White or Silver frame	66 x 30	KN2S6630/#300	\$1,600	\$1,245
	Kinetic height adjustable desk 2-Stage leg, Singlesided Woodgrain HPL Worksurface Specify Black, White or Silver frame		KN2S6630/####	\$1,805	\$1,385

Dimensions are nominal. 54" and 66" worksurfaces are on a 10-Day lead time
PCV edge banding is 2mm.

Kinetic height adjustable desks - 2 Stage

Full Assemblies - with Worksurfaces

Product	Description	Dimensions	Code	CAD	USD
	Kinetic height adjustable desk 2-Stage leg, Singlesided Classic White LPL Worksurface Specify Black, White or Silver frame	72 x 24	KN2S7224/#300	\$1,520	\$1,180
	Kinetic height adjustable desk 2-Stage leg, Singlesided Woodgrain HPL Worksurface Specify Black, White or Silver frame		KN2S7224/####	\$1,645	\$1,260
	Kinetic height adjustable desk 2-Stage leg, Singlesided Classic White LPL Worksurface Specify Black, White or Silver frame	72 x 30	KN2S7230/#300	\$1,600	\$1,245
	Kinetic height adjustable desk 2-Stage leg, Singlesided Woodgrain HPL Worksurface Specify Black, White or Silver frame		KN2S7230/####	\$1,805	\$1,385

Dimensions are nominal.
PCV edge banding is 2mm.

- Select finishes

Powdercoat **B** **W** **S** + Laminate **300** **8232** **7981** **8201**
LPL HPL

Kinetic height adjustable desks - 3 Stage

Full Assemblies - with Worksurfaces

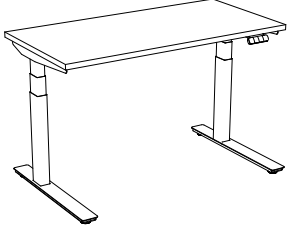
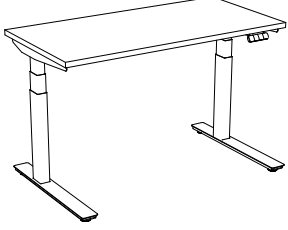
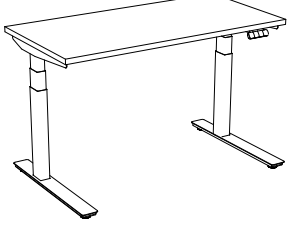
Product	Description	Dimensions	Code	CAD	USD
	Kinetic height adjustable desk 3-Stage leg, Singlesided Classic White LPL Worksurface Specify Black, White or Silver frame	48 x 24	KN3S4824/#300	\$1,545	\$1,190
	Kinetic height adjustable desk 3-Stage leg, Singlesided Woodgrain HPL Worksurface Specify Black, White or Silver frame		KN3S4824/####	\$1,650	\$1,255
	Kinetic height adjustable desk 3-Stage leg, Singlesided Classic White LPL Worksurface Specify Black, White or Silver frame	48 x 30	KN3S4830/#300	\$1,605	\$1,235
	Kinetic height adjustable desk 3-Stage leg, Singlesided Woodgrain HPL Worksurface Specify Black, White or Silver frame		KN3S4830/####	\$1,745	\$1,330
	Kinetic height adjustable desk 3-Stage leg, Singlesided Classic White LPL Worksurface Specify Black, White or Silver frame	54 x 24	KN3S5424/#300	\$1,585	\$1,225
	Kinetic height adjustable desk 3-Stage leg, Singlesided Woodgrain HPL Worksurface Specify Black, White or Silver frame		KN3S5424/####	\$1,720	\$1,315
	Kinetic height adjustable desk 3-Stage leg, Singlesided Classic White LPL Worksurface Specify Black, White or Silver frame	54 x 30	KN3S5430/#300	\$1,660	\$1,285
	Kinetic height adjustable desk 3-Stage leg, Singlesided Woodgrain HPL Worksurface Specify Black, White or Silver frame		KN3S5430/####	\$1,825	\$1,395

54" and 66" worksurfaces are on a 10-Day lead time

- Select finishes

Powdercoat **B** **W** **S** + Laminate **300** **8232** **7981** **8201**
LPL HPL

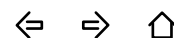

Kinetic height adjustable desks - 3 Stage

Full Assemblies - with Worksurfaces

Product	Description	Dimensions	Code	CAD	USD
	Kinetic height adjustable desk 3-Stage leg, Singlesided Classic White LPL Worksurface Specify Black, White or Silver frame	60 x 24	KN3S6024/#300	\$1,585	\$1,225
	Kinetic height adjustable desk 3-Stage leg, Singlesided Woodgrain HPL Worksurface Specify Black, White or Silver frame		KN3S6024/####	\$1,720	\$1,315
	Kinetic height adjustable desk 3-Stage leg, Singlesided Classic White LPL Worksurface Specify Black, White or Silver frame	60 x 30	KN3S6030/#300	\$1,660	\$1,285
	Kinetic height adjustable desk 3-Stage leg, Singlesided Woodgrain HPL Worksurface Specify Black, White or Silver frame		KN3S6030/####	\$1,825	\$1,395
	Kinetic height adjustable desk 3-Stage leg, Singlesided Classic White LPL Worksurface Specify Black, White or Silver frame	66 x 24	KN3S6624/#300	\$1,630	\$1,265
	Kinetic height adjustable desk 3-Stage leg, Singlesided Woodgrain HPL Worksurface Specify Black, White or Silver frame		KN3S6624/####	\$1,755	\$1,345
	Kinetic height adjustable desk 3-Stage leg, Singlesided Classic White LPL Worksurface Specify Black, White or Silver frame	66 x 30	KN3S6630/#300	\$1,710	\$1,330
	Kinetic height adjustable desk 3-Stage leg, Singlesided Woodgrain HPL Worksurface Specify Black, White or Silver frame		KN3S6630/####	\$1,915	\$1,465

54" and 66" worksurfaces are on a 10-Day lead time

- Select finishes

Powdercoat **B** **W** **S** + Laminate **300** **8232** **7981** **8201**
LPL HPL

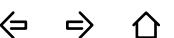

Kinetic height adjustable desks - 3 Stage

Full Assemblies - with Worksurfaces

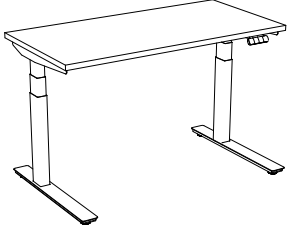
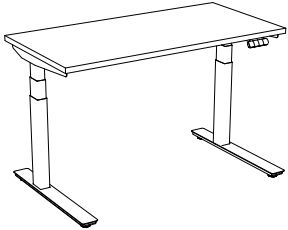
Product	Description	Dimensions	Code	CAD	USD
	Kinetic height adjustable desk 3-Stage leg, Singlesided Classic White LPL Worksurface Specify Black, White or Silver frame	72 x 24	KN3S7224/#300	\$1,630	\$1,125
	Kinetic height adjustable desk 3-Stage leg, Singlesided Woodgrain HPL Worksurface Specify Black, White or Silver frame		KN3S7224/####	\$1,755	\$1,205
	Kinetic height adjustable desk 3-Stage leg, Singlesided Classic White LPL Worksurface Specify Black, White or Silver frame	72 x 30	KN3S7230/#300	\$1,710	\$1,190
	Kinetic height adjustable desk 3-Stage leg, Singlesided Woodgrain HPL Worksurface Specify Black, White or Silver frame		KN3S7230/####	\$1,915	\$1,325

Dimensions are nominal. PCV edge banding is 2mm.

Kinetic - Electrical

	Voltra II Power Module with clamp for worksurface	Black	AGPM301U1C-B-108	\$260	\$250
	3 power 1 USB-A, 1 USB-C 108 L cord, #	White	AGPM301U1C-W-108	\$260	\$250

- Select finishes

Powdercoat **B** W S + Laminate **300** 8232 7981 8201
LPL HPL

Kinetic - Accessories

Modesty Panels

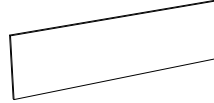
Product	Description	Dimensions	Code	CAD	USD
	Kinetic Modesty Panel Classic White LPL	for 48 W desk	KNM12/300	\$90	\$85
	Kinetic Modesty Panel Woodgrain HPL Select finish		KNM12/#	\$135	\$115
	Kinetic Modesty Panel Classic White LPL	for 60 W desk	KNM15/300	\$90	\$90
	Kinetic Modesty Panel Woodgrain HPL Select finish		KNM15/#	\$135	\$115
	Kinetic Modesty Panel Classic White LPL	for 72 W desk	KNM18/300	\$110	\$105
	Kinetic Modesty Panel Woodgrain HPL Select finish		KNM18/#	\$155	\$135

Casters

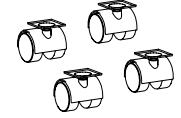
	Kinetic Caster Set Metal Caster, Locking Silver Dual surface Set of 4	Fits desks 48-72 x 24-30	AGCASTOR/SET	\$165	\$110
---	--	-----------------------------	--------------	-------	-------

Array & Vibe Electrical Information

We use the USA-based company Byrne Electrical for Array and Vibe power and data.

The Byrne 8-Trac System and Phase 3 are UL recognized as an Office Furnishing Accessory (UL 1286), and are UL Listed as a Manufactured Wiring System (UL 183) in full compliance with electrical specifications found in the National Electrical Code (NEC). It also complies with municipal standards such as New York, Los Angeles and San Francisco. To learn more about Byrne, visit their website at www.byrne-electrical.com

Universally recognized:

UL Listed as a Manufactured Wiring System (UL 183)

UL recognized as an office furnishing accessory (UL 1286)

cUL Certified for Canada

Meets National Electric Code (NEC) article 604 and NEC article 605

BIFMA Level 3

Complies with municipal standards such as New York, Los Angeles, & San Francisco

Circuitry/Keying:

The Byrne 8-Trac System is rated for 20 Amps allowing the use of 4 circuits with 4 line conductors, 2 neutrals and 2 grounds. Under NEC requirements, up to 13 duplex receptacles may be used per circuit, with a total of 52 available receptacles if all circuits are used, per single power entry. The line conductors are 12 AWG, and share a 12 AWG ground and a 10 AWG neutral. The fourth circuit is isolated and dedicated, and is serviced by its own line conductor, neutral and isolated ground. Alternate circuit diagrams are available. The Byrne System can be wired in both single and three-phase configurations, 240/120V, 208/120V respectively. Additionally, a 3 hot, 3 neutral, 2 ground (3-3-2) wiring system is available.

Flexibility:

The practical Design of the Byrne 8-Trac System combines junction blocks, jumpers, and power infeeds into one modular assembly. With 3-1/2" of adjustability, different length harnesses for 90 degree and "T" panel conditions are not required. Power is routed through extremely flexible oval metal conduit, which makes traversing sharp corners easy.

Installation:

All connections are positive locking, assured by keyed terminal housings. The patented slide mount block is easily installed on site after panel or table assembly.

Electrical — 3 Circuit

BYRNE 3-TRACK SYSTEM

The Phase 3 system from Byrne delivers reliable, flexible power distribution—ideal for modular office furniture. Designed for ease of use and customization, Phase 3 supports panel applications from 2" to 3½" thick with harnesses from 12" to 300" in length. All units are fully tested to ensure top quality and performance.

Key Features

Supports 3 separate circuits at 20 amps each, configured as a 3-circuit system (208/120V or 240/120V). Easily routes through sharp corners with flexible metal conduit.

Delivers power to single and both sides of Array beams or Vibe benching—perfect for open-plan layouts.

Dual-Sided Design

Fast, Secure Installation

Features positive-locking connections and slide-mount raceway for quick setup after assembly.

Certified & Compliant

The 3-circuit configuration delivers three separate 20A power circuits through a single modular system—ideal for high-capacity office layouts.

UL Listed (UL 183 & UL 1286)

cUL Certified for Canada

NEC 604 & 605 Compliant

BIFMA Level 3

Approved in NYC, LA, San Francisco

Wiring & Conductors

- 3 Line Conductors (Hot) – Each carries 20 amps on its own circuit (12 AWG)
- 1 Shared Neutral – Heavy-duty 10 AWG handles the return for all 3 circuits
- 1 Shared Ground – Ensures system grounding (12 AWG)

Power Infeed

- Configured exclusively as a 3-circuit system providing three distinct 20A circuits.

- Flexible power infeeds are designed to support this 3-circuit configuration.

Capacity

- Supports up to 13 duplex receptacles per 20A circuit (per NEC standards)
- Up to 39 duplex outlets total on the full 3-circuit system, depending on load.

Key Components

- Junction Blocks – Central connection points for distributing all three circuits
- Jumpers (Harnesses) – Carry power from beam to beam, available in 42", 48", 54", 60", 66" long.
- Flexible Metal Conduit – Simplifies routing around corners or tight spaces
- Dual-Sided Output – Supplies power to beams
- Positive-Locking Connectors – Ensure safe, tool-free installation

Keying for -3

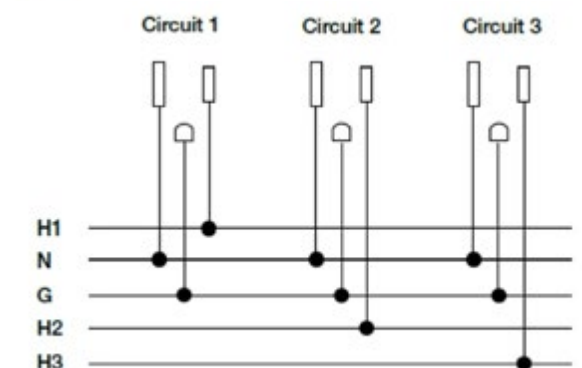

Electrical — 4 Circuit/8 Wire

BYRNE 8-TRAC SYSTEM

The 8-Trac system from Byrne provides reliable, flexible power distribution tailored for modular office furniture. Designed for easy customization and installation, 8-Trac supports panel thicknesses from 2" to 3½" and features harness lengths ranging from 12" to 300". Every unit undergoes rigorous testing to ensure superior quality and performance.

Key Features

Supports 4 separate circuits at 20 amps each, configured as a 4-circuit system (208/120V or 240/120V). Designed to navigate sharp corners easily with flexible metal conduit.

- Powerful & Flexible
- Dual-Sided Design
- Delivers power to both sides of Array beams or Vibe benching—ideal for open-plan and collaborative office environments.
- Fast, Secure Installation
- Equipped with positive-locking connectors and slide-mount raceway to enable quick, tool-free installation after assembly.

Certified & Compliant

The 4-circuit configuration delivers four separate 20A power circuits through a single modular system—perfect for high-density power needs in modern office layouts.

UL Listed (UL 183 & UL 1286)

cUL Certified for Canada

NEC 604 & 605 Compliant

BIFMA Level 3

Approved in NYC, LA, San Francisco

Wiring & Conductors

- 4 Line Conductors (Hot) – Each carries 20 amps on its own circuit (12 AWG)
- 1 Shared Neutral – Heavy-duty 10 AWG handles the return for all 4 circuits
- 1 Shared Ground – Ensures system grounding (12 AWG)

Power Infeed

- Configured exclusively as a 4-circuit system providing four distinct 20A circuits.
- Flexible power infeeds are designed specifically to support this 4-circuit configuration.

Capacity

- Supports up to 13 duplex receptacles per 20A circuit (per NEC standards)
- Up to 52 duplex outlets total on the full 4-circuit system, depending on load

Key Components:

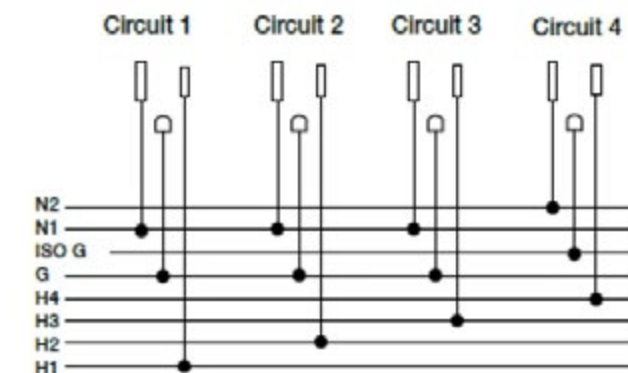

- Junction Blocks – Central connection points distributing all four circuits
- Jumpers (Harnesses) – Carry power from Array beams or Vibe benching, available from 42", 48", 54", 60", 66"

Keying 3+D







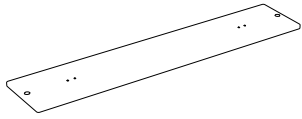
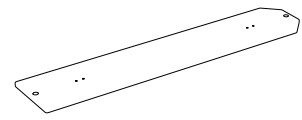
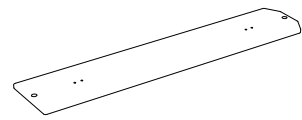
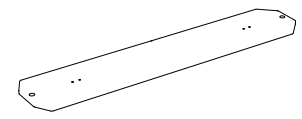
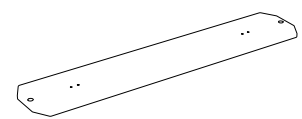
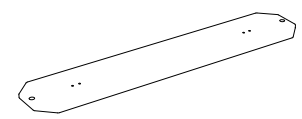



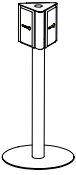
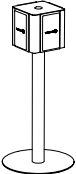



Array Power/Data Beam

Product	Description	Dimensions	Code	CAD	USD
	Array Beam Array Power Beam, with brackets for raceway, plates, covers and hardware. Specify Black, Silver or White.	48" wide	ARPB48/#	\$595	\$460
		60" wide	ARPB60/#	\$660	\$515
	Face plates are Light Grey.	72" wide	ARPB72/#	\$730	\$565
	Array A-Frame Leg Single Array Power Beam A-Frame Leg, with adjustable glides. Specify Black, White or Silver Legs sold individually.	10"w x 2"d x 16"h	ARLEG/#	\$290	\$225
Array Premium Surface, Laminate Specify Laminate finish. <i>10 Day Lead Time</i>					
	Straight end / Straight end	48" wide	ARWS48SS/####	\$285	\$185
		60" wide	ARWS60SS/####	\$300	\$195
		72" wide	ARWS72SS/####	\$415	\$270
	Straight end / 4-way post end	48" wide	ARWS48S4/####	\$285	\$185
		60" wide	ARWS60S4/####	\$300	\$195
		72" wide	ARWS72S4/####	\$415	\$270
	Straight end / 3-way post end	48" wide	ARWS48S3/####	\$285	\$185
		60" wide	ARWS60S3/####	\$300	\$195
		72" wide	ARWS72S3/####	\$415	\$270
	3-way post end / 4-way post end	48" wide	ARWS4834/####	\$285	\$185
		60" wide	ARWS6034 /####	\$300	\$195
		72" wide	ARWS7234/####	\$415	\$270
	3-way post on both ends	48" wide	ARWS4833/####	\$285	\$185
		60" wide	ARWS6033/####	\$300	\$195
		72" wide	ARWS7233/####	\$415	\$270
	4-way post on both ends	48" wide	ARWS4844/####	\$285	\$185
		60" wide	ARWS6044/####	\$300	\$195
		72" wide	ARWS7244/####	\$415	\$270

Array Power/Data Beam





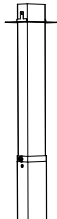

Product	Description	Dimensions	Code	CAD	USD
	Array 3-Way Post Array Power Beam Post, 3-Way, with 3 plastic covers. Specify Black, White or Silver	Base 9-7/16" h Top 5"-21" h	AR3P/#	\$370	\$290
	Array 4-Way Post Array Power Beam Post, 4-Way, with 4 plastic covers. Specify Black, White or Silver	Base 9-7/16" h Top 21" h	AR4P/#	\$370	\$290
	Versi Screen, Linear Versi Linear screens available in 45", 57" and 69" widths in all available heights.	See page 104 for finishes, pricing and specification information.			
	Array Privacy Screen Brackets Array Screen Brackets, with hardware. Set of 2.	2.4"w x 1.6"d x 4.8"h	ARSB/#	\$170	\$130
	Array Whiteboard Array Whiteboard with magnetic, wipeable finish. White.	32 W x 42 H	ARWB	\$155	\$120
	Array Whiteboard Brackets, for use without Premium Surface Array Whiteboard Brackets, for Array Power Beam for use without Premium Surface. Set of 2. Specify Black, White or Silver	2.5"w x 2.1"d x 5.6"h	ARWBBS/#	\$170	\$130
	Array Whiteboard Brackets, for use with Premium Surface Array Whiteboard Brackets, for Array Power Beam with Premium Surface, set of 2. Specify Black, White or Silver	2.5"w x 4.9"d x 5.5"h	ARWBBS/#	\$170	\$130

Array Power/Data Beam

Product	Description	Dimensions	Code	CAD	USD
	Array Storage Box, Rectangle Rectangle Stackable Storage Box. Steel, powder coated. Specify Black or White	24 x 10 x 13 H	ARBX24/#	\$370	\$290
	Array Storage Box, Square Square Stackable Storage Box. Steel, powder coated. Specify Black or White	12 x 10 x 13 H	ARBX12/#	\$255	\$200
	Array Planter Box Includes watering tube and separator grid. Steel. Specify Black or White	24 x 10 x 8 H	ARPL/#	\$425	\$330
	Array Dimmable Light LED Light for Array Power Beam Specify Black or White	10 x 43 H	ARNL/#	\$325	\$250
	Array Cable Tray Array Cable Tray Specify Black, White or Silver	31.5"w x 2.7" x 3.9"	ARCT/#	\$155	\$120
	Array Power Pole Array Power Pole, with connecting bridge to Array beam or Vibe benching , 144 L Specify Black, White or Silver	3- and 4-circuit	ARPP12/#	\$745	\$580
	Cable Sleeve Cable Sleeve, felt with zip and hardware, 6 x 39 L	Ash	CABSL/AS	\$85	\$65
		Charcoal	CABSL/CL	\$85	\$65

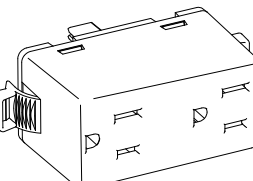

Array Power/Data Beam - Electrical

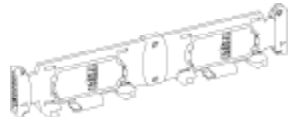
3-Circuit Hardwire Power

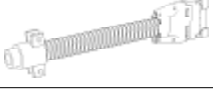

Product	Description	Color/Power	Code	CAD	USD
	Ceiling Infeed 180L	3 circuit	BE52825-3-180	\$785	\$475
	Base Infeed Base Feed, 120L	3 circuit	BE52825-3-120	\$385	\$250
	Infeed for NY with box, 72 L	3 circuit	BE53171-3-2A-72	\$870	\$565
		42 L	BE53288-3-42	\$195	\$125
		48 L	BE53288-3-48	\$210	\$140
		54 L	BE53288-3-54	\$230	\$150
		60 L	BE53288-3-60	\$250	\$160
		66 L	BE53288-3-66	\$170	\$175
	Jumper Cable 3 circuit adjustable pass-thru				
		Silver Grey	BE52426-3-G-1-AU	\$60	\$40
		Black	BE52426-3-G-1-C	\$60	\$40
		White	BE52426-3-G-1-WW	\$60	\$40
	Duplex Receptacle Duplex receptacle, 3 circuit 15 amp Circuit #1				
		Silver Grey	BE52426-3-G-2-AU	\$60	\$40
		Black	BE52426-3-G-2-C	\$60	\$40
		White	BE52426-3-G-2-WW	\$60	\$40
		Silver Grey	BE52426-3-G-3-AU	\$60	\$40
		Black	BE52426-3-G-3-C	\$60	\$40
		White	BE52426-3-G-3-WW	\$60	\$40
	Y-Connector 3 circuit, F/F/M	Black	BE52418-3	\$75	\$50
	Raceway 3 circuit Black	Double sided. Add 2 Duplex each side. Black.	BE52413-3-2-30	\$155	\$100

Array Power/Data Beam - Electrical

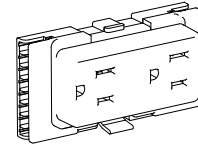
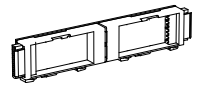
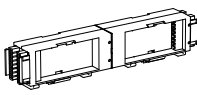
4-Circuit Hardwire Power

Product	Description	Color/Power	Code	CAD	USD
	Ceiling Infeed Ceiling Infeed, 180L	4 circuit	BE08092-3-180	\$695	\$450
	Base Infeed Base Feed, 120L	4 circuit	BE08092-3-ST-RT-120	\$580	\$375
	Infeed for NY With box, 72L	4-circuit	BE08254-3-2A-72	\$870	\$565
		42 L	BE08116-3-42	\$330	\$215
		48 L	BE08116-3-48	\$345	\$225
		54 L	BE08116-3-54	\$365	\$240
		60 L	BE08116-3-60	\$385	\$250
		66 L	BE08116-3-66	\$405	\$265
		72 L	BE08116-3-72	\$425	\$275
	Jumper Cable 4 circuit adjustable pass-thru				
	Duplex Receptacle Duplex receptacle, 4 circuit 15 amp Circuit #1	Silver Grey	BE08065-3-G-1-AU		
		Black	BE08065-3-G-1-C	\$60	\$40
		White	BE08065-3-G-1-WW		
		Silver Grey	BE08065-3-G-2-AU		
		Black	BE08065-3-G-2-C	\$60	\$40
		White	BE08065-3-G-2-WW		
		Silver Grey	BE08065-3-G-3-AU		
		Black	BE08065-3-G-3-C	\$60	\$40
		White	BE08065-3-G-3-WW		
		Silver Grey	BE08065-3-G-4-AU		
		Black	BE08065-3-G-4-C	\$60	\$40
		White	BE08065-3-G-4-WW		
		Silver Grey	BE08065-3-G-6-AU		
		Black	BE08065-3-G-6-C	\$60	\$40
		White	BE08065-3-G-6-WW		
	Raceway 4 circuit Black	Single sided add 2 Duplex one side	BE08382-3-2-30-00	\$250	\$165
	Raceway 4 circuit Black	Double sided add 2 Duplex each side	BE08290-3-2-30-00	\$270	\$175

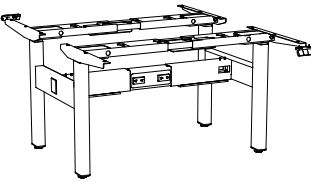
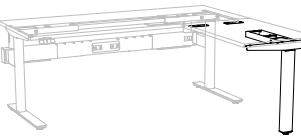
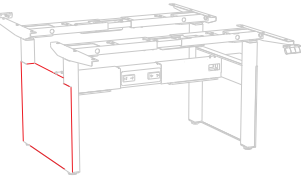
Vibe height adjustable benching

Product	Description	Size	Code	CAD	USD
	Vibe Single Run Height Adjustable Desk Frame 2-Stage leg, dual motor, crossbeam, and connector. Order power separately. Specify Black, White or Silver.	48/54/60/66/72 W x 24 For 24" deep work surface.	VBSS2S24/##	\$2,525	\$1,885
		48/54/60/66/72 W x 30 For 30" deep work surface.	VBSS2S30##	\$2,545	\$1,905
	Vibe Double Run Height Adjustable Desk Frame 2-Stage leg, dual motor, crossbeam and connector. 2 Pod, Doublesided. Order power separately. Specify Black, White or Silver.	48/54/60/66/72 W x 24 for 24" deep worksurface	VBDS2S24/##	\$3,955	\$2,950
		48/54/60/66/72 W x 30 for 30" deep worksurface	VBDS2S30/##	\$3,975	\$2,960
	Vibe Return Frame Vibe Return Frame with controls, LH or RH. Works with Vibe SSD or DSD Specify Black, White or Silver.	30/36/42/48 x 24/30	VBR2S/##	\$905	\$680
	Privacy End Panels Vibe Privacy End Panel for doublesided desks. Set of 2, no mounting bracket required. Specify Black, White or Silver.	for doublesided 24 D desks	VBGP24/#	\$310	\$230
		for doublesided 30 D desks	VBGP30/#	\$345	\$260
	Versi Privacy Screen Versi Linear screens available in 28" high X 45", 51", 57", 63" and 69" wide. See page 104 for finishes, pricing and specification information.				
	Vibe Screen Brackets Vibe Privacy Screen Brackets with hardware, for mounting Versi screens on Vibe beam. Set of 2. Specify Black, White or Silver.	2.4w x 1.57d x 4.72h	VBSB/#	\$155	\$115



Powdercoat frame



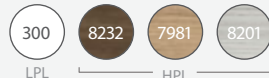

Laminate

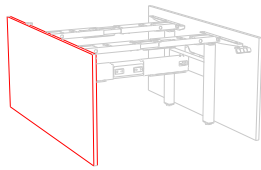

Vibe height adjustable benching

Product	Description	Size	Code	CAD	USD	
	Gallery End Panel Laminate end panel. Sold individually. Specify size/finish.					
		52 W x 30 H, Classic White	VBGEP105004-300	\$430	\$375	
		52 W x 30 H, Woodgrain	VBGEP105004-####	\$600	\$525	
		for 24" D Doublesided Desks				
		52 W x 47 H, Classic White	VBGEP105006-300	\$545	\$475	
		52 W x 47 H, Woodgrain	VBGEP105006-####	\$1,000	\$875	
		for 30" D Doublesided Desks				
		64 W x 30 H, Classic White	VBGEP105005-300	\$545	\$475	
64 W x 30 H, Woodgrain	VBGEP105005-####	\$700	\$615			
64 W x 47 H, Classic White	VBGEP105007-300	\$700	\$615			
64 W x 47 H, Woodgrain	VBGEP105007-####	\$1,215	\$1,065			
	Vibe Gallery End Panel Mounting Kit Includes 1 bracket, bridge and mounting plate. Specify Black, White or Silver.		VBGM/#	\$210	\$160	

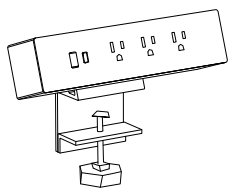
Vibe - Electrical

Product	Description	Size/Color	Code	CAD	USD
	Voltra II Power Module with clamp for worksurface 3 power 1 USB-A, 1 USB-C 108 L cord, #	Black	AGPM301U1C-B-108	\$260	\$250
		White	AGPM301U1C-W-108	\$260	\$250
	Vibe Cable Tray Specify Black, White or Silver	31.5"w x 2.7" x 3.9"	VBCT/#	\$195	\$145
	Cable Sleeve Cable Sleeve, felt with zip and hardware, 6 x 39 L	Ash	CABSL/AS	\$85	\$65
		Charcoal	CABSL/CL	\$85	\$65

Axis Fixed Height Desking

Frames:

- Arctic White or Silver Powdercoat finish to frame
- 2 x 2" square legs
- 2 x 1" rails
- 28.75" Worksurface height

Worksurfaces:

- 1" M2 Grade substrate
- Finish in Classic White LPL or 3 woodgrain HPLs
- Matching 2mm PVC edge
- 90° worksurface comes as with join at 47" along the left or right hand side

Axis Screens:

- Specify Clamp Mount with Extra Depth (see Versi section).
- Aluminum channel and four brackets (specify for white or silver frame)
- Available in Ripple palette

Desk

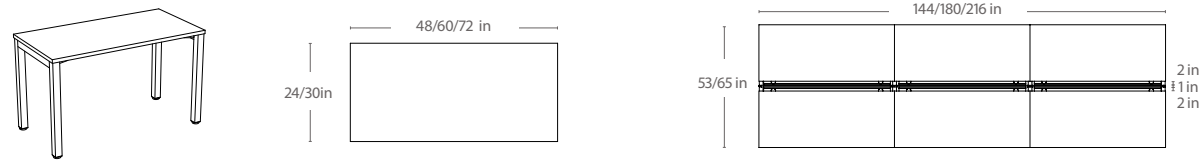

90° Workstation

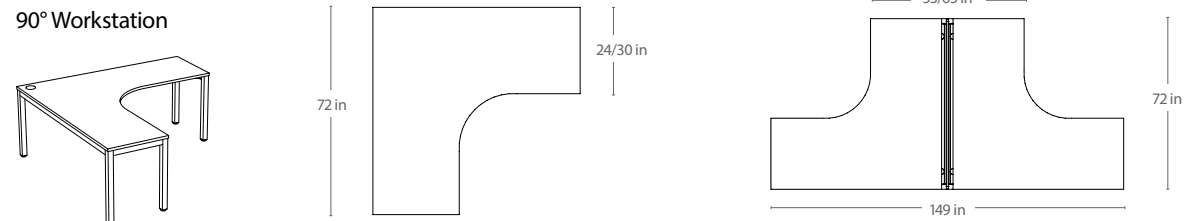

120° Workstation

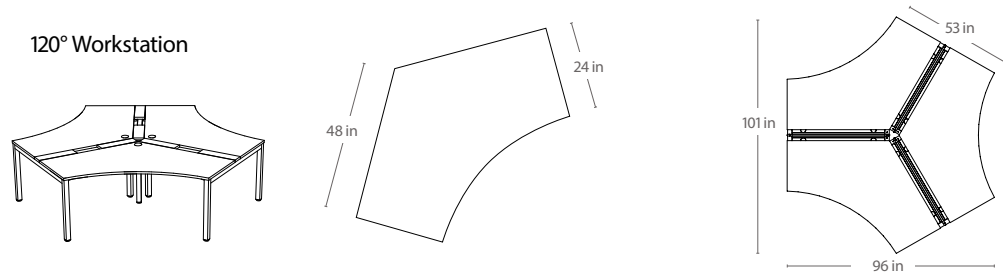

Desk & Return

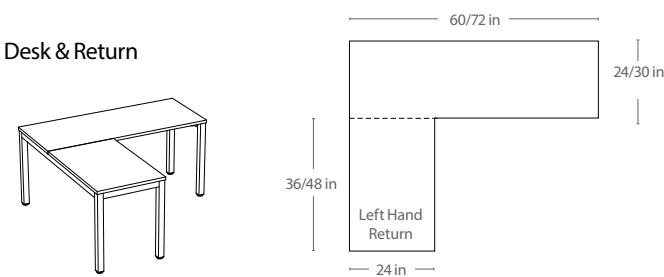

Axis Screens

Axis Spine Screens

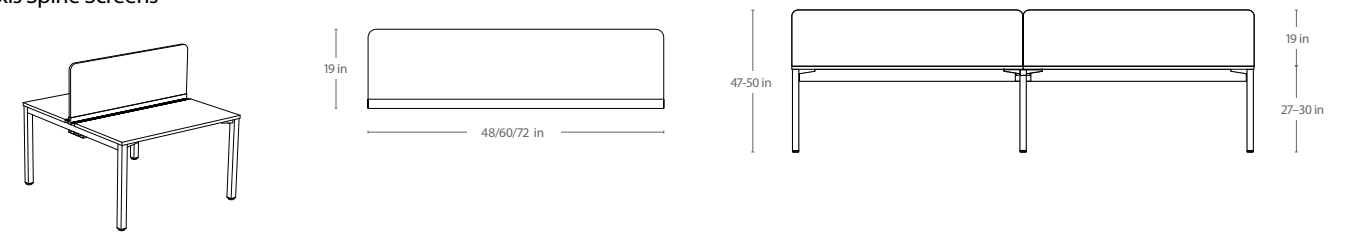

Axis Desk Hung Screens

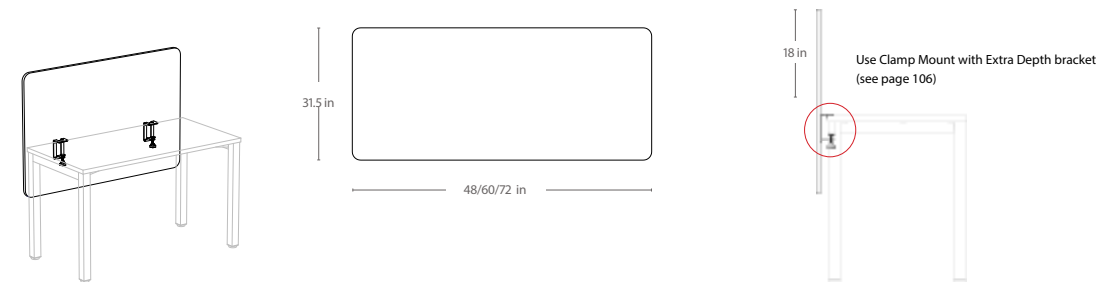

Axis Return Screens

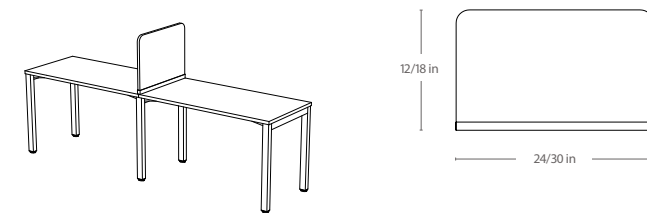

* All dimensions are nominal



- Select PET finish

Ripple Collection

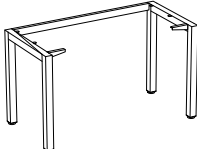

Axis Desking

Frames only

Product	Description	Worktop	Code	CAD	USD
	Desk, frame Fixed height Specify Silver or White	48" x 24"	AXSD126/#F	\$430	\$385
		48" x 30"	AXSD1275/#F	\$475	\$425
		60" x 24"	AXSD156/#F	\$455	\$405
		60" x 30"	AXSD1575/#F	\$495	\$500
		72" x 24"	AXSD186/#F	\$465	\$415
		72" x 30"	AXSD1875/#F	\$510	\$455
	Upgrade Modesty panel Specify Laminate color	42.5" wide x 12" deep	AXM12/#	\$105	\$95
		54.5" wide x 12" deep	AXM15/#	\$105	\$95
		66.25" wide x 12" deep	AXM18/#	\$120	\$110

NOTE: If a conference desk is required, order a worksurface 6" deeper than frame.

- Select finishes

Powdercoat frame



Laminate

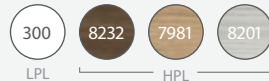

Axis Desk & Return

Frames only

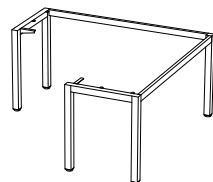
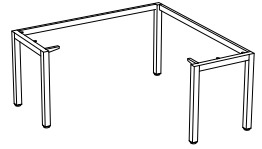
Product	Description	Worktop	Code	CAD	USD
	Desk and Left hand return, frame Fixed height	60" x 24"/36" x 24"	AXDR156156/#LF	\$635	\$575
		60" x 24"/48" x 24"	AXDR156186/#LF	\$640	\$575
		60" x 30"/42" x 30"	AXDR15751875/#LF	\$650	\$570
		72" x 24"/36" x 24"	AXDR186156/#LF	\$645	\$585
		72" x 24"/48" x 24"	AXDR186186/#LF	\$655	\$585
		72" x 30"/42" x 30"	AXDR18751875/#LF	\$890	\$795
	Desk and Right hand return, frame Fixed height	60" x 24"/36" x 24"	AXDR156156/#RF	\$635	\$575
		60" x 24"/48" x 24"	AXDR156186/#RF	\$640	\$575
		60" x 30"/42" x 30"	AXDR15751875/#RF	\$650	\$570
		72" x 24"/36" x 24"	AXDR186156/#RF	\$645	\$585
		72" x 24"/48" x 24"	AXDR186186/#RF	\$655	\$585
		72" x 30"/42" x 30"	AXDR18751875/#RF	\$890	\$795

NOTE: If a conference desk is required, order a worksurface 6" deeper than frame.

- Select finishes

Powdercoat frame



Axis Shared Desking

Frames only

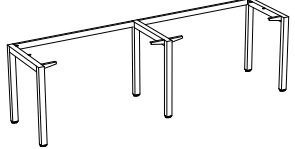
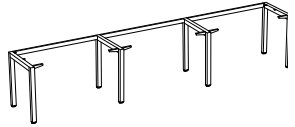
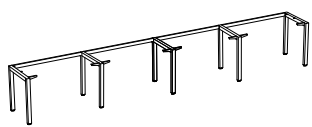
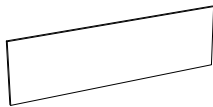
Product	Description	Worktop	Code	CAD	USD
<i>*All shared desking shows pricing per pod.</i>					
	Desk frame, 2 user Single sided 2 User Specify White or Silver	2 @ 48" x 24"	AX2SSD126/#F	\$730	\$655
		2 @ 48" x 30"	AX2SSD1275/#F	\$805	\$720
		2 @ 60" x 24"	AX2SSD156/#F	\$770	\$690
		2 @ 60" x 30"	AX2SSD1575/#F	\$840	\$870
		2 @ 72" x 24"	AX2SSD186/#F	\$800	\$710
		2 @ 72" x 30"	AX2SSD1875/#F	\$870	\$775
	Desk frame, 3 user Single sided 3 User Specify White or Silver	3 @ 48" x 24"	AX3SSD126/#F	\$1030	\$920
		3 @ 48" x 30"	AX3SSD1275/#F	\$1,135	\$1,015
		3 @ 60" x 24"	AX3SSD156/#F	\$1,090	\$975
		3 @ 60" x 30"	AX3SSD1575/#F	\$1,195	\$1,250
		3 @ 72" x 24"	AX3SSD186/#F	\$1,125	\$1,000
		3 @ 72" x 30"	AX3SSD1875/#F	\$1,230	\$1,100
	Desk frame, 4 user Single sided 4 User Specify White or Silver	4 @ 48" x 24"	AX4SSD126/#F	\$1,370	\$1,225
		4 @ 48" x 30"	AX4SSD1275/#F	\$1,515	\$1,350
		4 @ 60" x 24"	AX4SSD126/#F	\$1,450	\$1,300
		4 @ 60" x 30"	AX4SSD1275/#F	\$1,590	\$1,665
		4 @ 72" x 24"	AX4SSD126/#F	\$1,500	\$1,335
		4 @ 72" x 30"	AX4SSD1275/#F	\$1,500	\$1,335
	Upgrade Modesty panel Laminate Specify finish	42.5" W x 12" D for 48" desk	AXM12/300	\$105	\$95
			AXM12/####	\$145	\$120
		54.5" W x 12" D for 60" desk	AXM15/300	\$105	\$95
			AXM15/####	\$150	\$125
		66.25" W x 12" D for 72" desk	AXM18/300	\$120	\$110
			AXM18/####	\$170	\$145

Please note: Single sided desk cable management can be found on page 40

- Select finishes

Powdercoat frame



Laminate

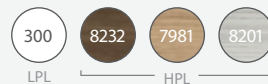

Axis Shared Desking

Frames only

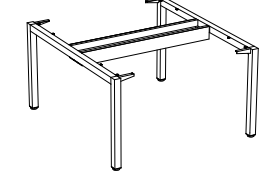
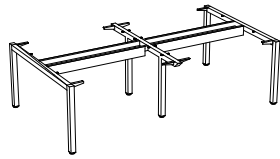
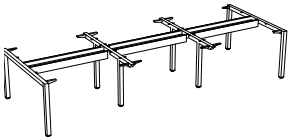
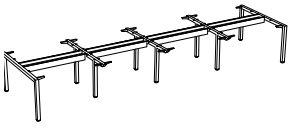
Product	Description	Worktop	Code	CAD	USD
	Desk, frame Double sided 2 User Cable trays Specify White or Silver	2 @ 48" x 24"	AX2DSD126/#F	\$1,015	\$905
		2 @ 48" x 30"	AX2DSD1275/#F	\$1,050	\$940
		2 @ 60" x 24"	AX2DSD156/#F	\$1,095	\$980
		2 @ 60" x 30"	AX2DSD1575/#F	\$1,135	\$1,135
		2 @ 72" x 24"	AX2DSD186/#F	\$1,180	\$1,055
		2 @ 72" x 30"	AX2DSD1875/#F	\$1,220	\$1,085
	Desk, frame Double sided 4 User Cable trays Specify White or Silver	4 @ 48" x 24"	AX4DSD126/#F	\$1,680	\$1,515
		4 @ 48" x 30"	AX4DSD1275/#F	\$1,730	\$1,555
		4 @ 60" x 24"	AX4DSD156/#F	\$1,860	\$1,660
		4 @ 60" x 30"	AX4DSD1575/#F	\$1,900	\$1,930
		4 @ 72" x 24"	AX4DSD186/#F	\$2,015	\$1,805
		4 @ 72" x 30"	AX4DSD1875/#F	\$2,070	\$1,845
	Desk, frame Double sided 6 User Cable trays Specify White or Silver	6 @ 48" x 24"	AX6DSD126/#F	\$2,370	\$2,120
		6 @ 48" x 30"	AX6DSD1275/#F	\$2,445	\$2,185
		6 @ 60" x 24"	AX6DSD156/#F	\$2,615	\$2,345
		6 @ 60" x 30"	AX6DSD1575/#F	\$2,660	\$2,895
		6 @ 72" x 24"	AX6DSD186/#F	\$2,880	\$2,560
		6 @ 72" x 30"	AX6DSD1875/#F	\$2,905	\$2,590
	Desk, frame Double sided 8 User Cable trays Specify White or Silver	8 @ 48" x 24"	AX8DSD126/#F	\$3,160	\$2,825
		8 @ 48" x 30"	AX8DSD1275/#F	\$3,255	\$2,915
		8 @ 60" x 24"	AX8DSD156/#F	\$3,490	\$3,655
		8 @ 60" x 30"	AX8DSD1575/#F	\$3,550	\$3,655
		8 @ 72" x 24"	AX8DSD186/#F	\$3,840	\$3,415
		8 @ 72" x 30"	AX8DSD1875/#F	\$3,870	\$3,455

- Select finishes

Powdercoat frame



Please note:

Cable tray covers can be found on page 40

**All shared desking shows pricing per pod.*

Axis 90° Workstations

Frames only

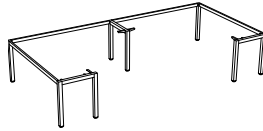
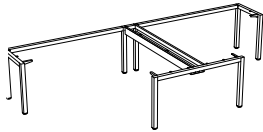
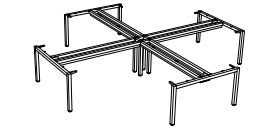
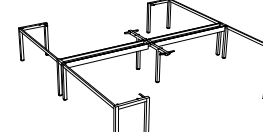
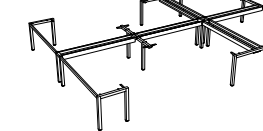
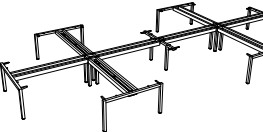
Product	Description	Worktop	Code	CAD	USD
	90° Workstation, frames 2 User	2 @ 72" x 72" x 24"	AX2U186186/#F	\$1,155	\$1,035
		2 @ 72" x 72" x 30"	AX2U187187/#F	\$1,335	\$1,190
	90° Workstation, frames T layout 2 User Cable trays	2 @ 72" x 72" x 24"	AX2T186186/#F	\$1,625	\$1,450
		2 @ 72" x 72" x 30"	AX2T187187/#F	\$1,790	\$1,595
	90° Workstation, frames Plus layout 4 User Cable trays	4 @ 72" x 72" x 24"	AX4P186186/#F	\$3,920	\$3,490
		4 @ 72" x 72" x 30"	AX4P187187/#F	\$4,200	\$3,745
	90° Workstation, frames H layout 4 User Cable trays	4 @ 72" x 72" x 24"	AX4H186186/#F	\$2,920	\$2,595
		4 @ 72" x 72" x 30"	AX4H187187/#F	\$3,205	\$2,860
	90° Workstation, frames 6 User Cable trays	6 @ 72" x 72" x 24"	AX6PT186186/#F	\$5,205	\$4,625
		6 @ 72" x 72" x 30"	AX6PT187187/#F	\$5,620	\$5,010
	90° Workstation, frames Double plus layout 8 User Cable trays	8 @ 72" x 72" x 24"	AX8P186186/#F	\$7,490	\$6,690
		8 @ 72" x 72" x 30"	AX8P187187/#F	\$8,020	\$7,150

*All shared desking shows pricing per pod.

Please note:
Cable tray covers can be found on page 40

- Select finishes

Powdercoat frame S W

Axis 120° Workstations

Frames only

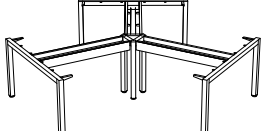
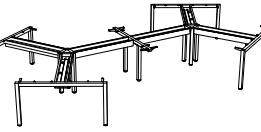
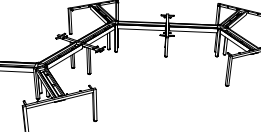
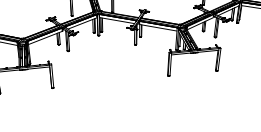
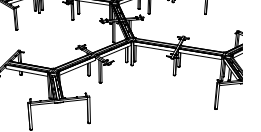
Product	Description	Worktop	Code	CAD	USD
	120° Workstation, frames 3 User Cable trays	3 @ 48" x 48" x 24"	AX3SW12126/#F	\$2,485	\$2,380
	120° Workstation, frames 6 User Cable trays	6 @ 48" x 48" x 24"	AX6SW12126/#F	\$4,975	\$4,755
	120° Workstation, frames 9 User Cable trays	9 @ 48" x 48" x 24"	AX9SW12126/#F	\$7,460	\$7,130
	120° Workstation, frames 12 User Cable trays	12 @ 48" x 48" x 24"	AX12SW12126/#F	\$9,945	\$9,505
	120° Workstation, frames 18 User Cable trays	18 @ 48" x 48" x 24"	AX18SW12126/#F	\$14,920	\$14,260

*All shared desking shows pricing per pod.

Please note:
Cable tray covers can be found on page 52



- Select finishes

Powdercoat frame S W

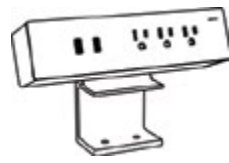
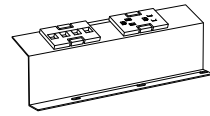
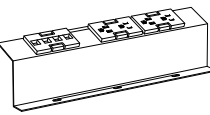
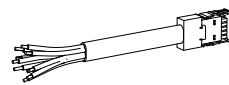
Axis Electrical

Product	Description	Dimensions	Code	CAD	USD
	Voltra II Power Module with clamp for Axis desk rail 3 power 1 USB-A, 1 USB-C 108 L cord, #	White	AXPM3O1U1C-W-108	\$260	\$250
		Black	AXPM3O1U1C-B-108	\$260	\$250
	One Duplex For one duplex in tray		ELECTRICAL_1	\$265	\$200
	Two Duplex For two duplexes in tray		ELECTRICAL_2	\$480	\$365
	Base Infeed Hardware	Standard - 72"	EHINFD-72	\$290	\$220
		NYC - 72"	EHNYCINFD-72	N/A	\$207
	Ceiling Infeed Hardware	Standard - 144"	EHINFD-144	\$350	\$265
		NYC - 144"	EHNYCINFD-144	N/A	\$265

Accessories

Product	Description	Dimensions	Code	CAD	USD
	Eclipse Tray Tidy with hardwire power Silver	48"	ECTT48WP/S	\$80	\$80
		60"	ECTT60WP/S	\$100	\$100
		72"	ECTT72WP/S	\$115	\$120
	Eclipse Tray Tidy without hardwire power Silver	48"	ECTT48NP/S	\$80	\$80
		60"	ECTT60NP/S	\$100	\$100
		72"	ECTT72NP/S	\$115	\$120

Please note:

- All electrical prices include all required jumper cables, connecting hardware, duplexes, electrical face plate, and data face plate with four knockouts
- Single-sided desks can only have below desk electrical, and double sided desks can only have above desk electrical.

Axis Screens

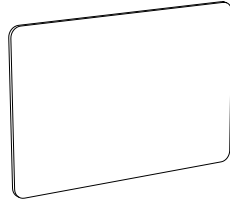
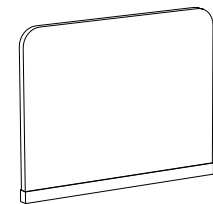
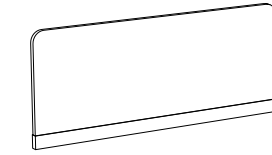
Product	Description	Dimensions	Code	CAD	USD
	Axis Screen, Desk Hung Screen only* Available in 8 Ripple colors	48 W x 32 H	ASH48/#	\$415	\$305
		60 W x 32 H	ASH60/#	\$520	\$385
		72 W x 32 H	ASH72/#	\$625	\$465
	Axis Screen, Return Screen with aluminum channel Available in 8 Ripple colors	23 W x 12 H	ASR23-12/#	\$ 200	\$170
		23 W x 18 H	ASR23-18/#	\$240	\$205
		29 W x 12 H	ASR29-12/#	\$235	\$200
		29 W x 18 H	ASR29-18/#	\$265	\$240
	Axis Screen, Spine with aluminum channel Available in 8 Ripple colors Brackets (4): Silver or White to match Axis desk frame	48 W x 19 H	ASS48#/#	\$565	\$505
		60 W x 19 H	ASS60#/#	\$695	\$625
		72 W x 19 H	ASS72#/#	\$775	\$695

*Use with Versi Clamp Mount with Extra Depth brackets, page 108

- Select PET finish

Ripple Collection



Worksurfaces - Linear

24", 36", 39" and 48" Wide

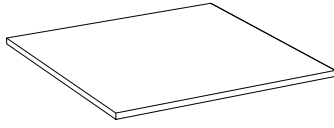
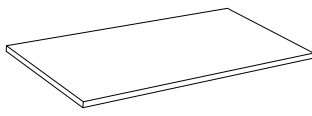
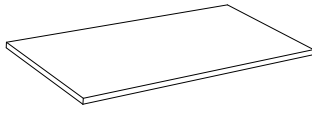
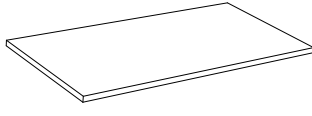
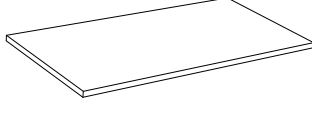
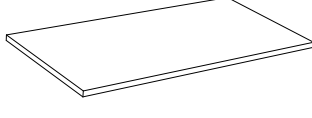
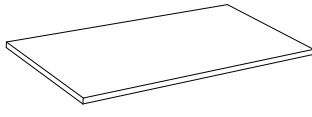
Product	Description	Dimensions	Code	CAD	USD
	Worksurface LPL Classic White	24 x 24	WS101001-300	\$105	\$95
	Worksurface HPL Woodgrain Specify Finish		WS101001-#	\$135	\$115
	Worksurface LPL Classic White	36 x 24	WS101002-300	\$140	\$115
	Worksurface HPL Woodgrain Specify Finish		WS101002-#	\$205	\$170
	Worksurface LPL Classic White	39 x 39	WS101023-300	\$255	\$230
	Worksurface HPL Woodgrain Specify Finish		WS101023-#	\$510	\$395
	Worksurface LPL Classic White	42 x 24	WS101045-300	\$160	\$145
	Worksurface HPL Woodgrain Specify Finish		WS101045-#	\$205	\$185
	Worksurface LPL Classic White	42 x 30	WS101046-300	\$175	\$160
	Worksurface HPL Woodgrain Specify Finish		WS101046-#	\$285	\$230
	Worksurface LPL Classic White	48 x 24	WS101003-300	\$200	\$180
	Worksurface HPL Woodgrain Specify Finish		WS101003-#	\$310	\$250
	Worksurface LPL Classic White	48 x 30	WS101004-300	\$240	\$215
	Worksurface HPL Woodgrain Specify Finish		WS101004-#	\$385	\$310

The dimensions listed are nominal and represent the closest metric equivalent. Ex: 48x24 = 1200mm x 600mm, which is slightly smaller. PCV edge banding is 2mm.

- Select finishes

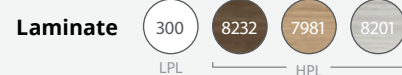

Worksurfaces - Linear

54", 60" and 66" Wide

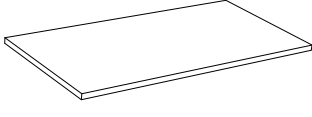
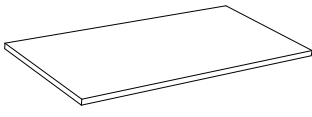
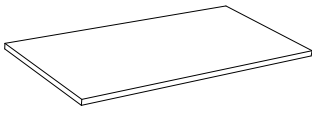
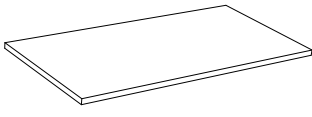
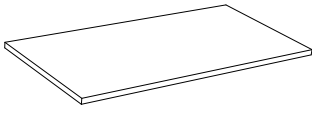
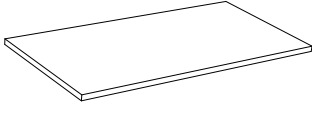
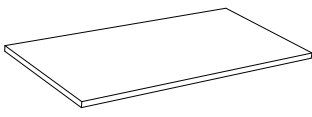
Product	Description	Dimensions	Code	CAD	USD
	Worksurface LPL Classic White	54 x 24	WS101057-300	\$240	\$215
	Worksurface HPL Woodgrain Specify Finish		WS101057-#	\$385	\$310
	Worksurface LPL Classic White	54 x 30	WS101058-300	\$295	\$265
	Worksurface HPL Woodgrain Specify Finish		WS101058-#	\$470	\$380
	Worksurface LPL Classic White	60 x 24	WS101005-300	\$240	\$215
	Worksurface HPL Woodgrain Specify Finish		WS101005-#	\$385	\$310
	Worksurface LPL Classic White	60 x 30	WS101006-300	\$295	\$265
	Worksurface HPL Woodgrain Specify Finish		WS101006-#	\$470	\$380
	Worksurface LPL Classic White	60 x 48	WS101024-300	\$485	\$435
	Worksurface HPL Woodgrain Specify Finish		WS101024-#	\$790	\$635
	Worksurface LPL Classic White	66 x 24	WS101059-300	\$290	\$260
	Worksurface HPL Woodgrain Specify Finish		WS101059-#	\$420	\$345
	Worksurface LPL Classic White	66 x 30	WS101060-300	\$350	\$310
	Worksurface HPL Woodgrain Specify Finish		WS101060-#	\$565	\$455

Sizes are nominal





54" and 66" worksurfaces are on a 10-Day lead time

- Select finishes

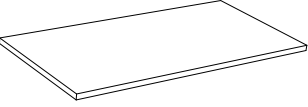

Worksurfaces - Linear

72" and 96" Wide

Product	Description	Dimensions	Code	CAD	USD
	Worksurface LPL Classic White	72 x 24	WS101007-300	\$290	\$260
	Worksurface HPL Woodgrain Specify Finish		WS101007-#	\$420	\$345
	Worksurface LPL Classic White	72 x 30	WS101008-300	\$350	\$310
	Worksurface HPL Woodgrain Specify Finish		WS101008-#	\$565	\$455
	Worksurface LPL Classic White	72 x 36	WS101009-300	\$345	\$315
	Worksurface HPL Woodgrain Specify Finish		WS101009-#	\$620	\$495
	Worksurface LPL Classic White	72 x 48	WS101025-300	\$505	\$405
	Worksurface HPL Woodgrain Specify Finish		WS101025-#	\$830	\$665
	Worksurface LPL Classic White	96 x 48	WS101026-300	\$630	\$565
	Worksurface HPL Woodgrain Specify Finish		WS101026-#	\$1,160	\$900

The dimensions listed are nominal and represent the closest metric equivalent.
Ex: 48x24 = 1200mm x 600mm, which is slightly smaller.

PCV edge banding is 2mm.

Worksurfaces - Linear

Linear with Interact Cutouts

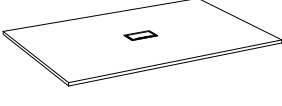
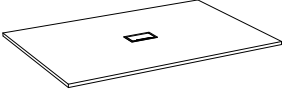
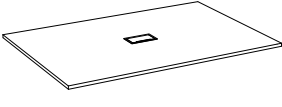

Product	Description	Dimensions	Code	CAD	USD
	Worksurface 1 Interact Cutout LPL Classic White	60 x 48	WS101027-300	\$485	\$435
	Worksurface 1 Interact Cutout HPL Woodgrain Specify finish		WS101027-#	\$790	\$630
	Worksurface 1 Interact Cutout LPL Classic White	72 x 48	WS101028-300	\$505	\$455
	Worksurface 1 Interact Cutout HPL Woodgrain Specify finish		WS101028-#	\$830	\$655
	Worksurface 1 Interact Cutout LPL Classic White	96 x 48	WS101029-300	\$630	\$565
	Worksurface 1 Interact Cutout HPL Woodgrain Specify finish		WS101029-#	\$1,160	\$900

The dimensions listed are nominal and represent the closest metric equivalent.
Ex: 48x24 = 1200mm x 600mm, which is slightly smaller.



PCV edge banding is 2mm.

Worksurfaces - Curved

90° Worksurfaces

Product	Description	Dimensions	Code	CAD	USD
	90 Degree Worksurface with return LPL Classic White	72 x 72 / 24	Left: AX9W18186/WL Right: AX9W18186/WR	\$605	\$545
	90 Degree Worksurface with return LPL Classic White	72 x 72 / 30	Left: AX9W181875/WL Right: AX9W181875/WR	\$655	\$585



120° Worksurfaces

Product	Description	Dimensions	Code	CAD	USD
	120 Degree Worksurface LPL Classic White	48 x 48 x 24	WS131038-300	\$615	\$550
	120 Degree Worksurface HPL Woodgrain Specify Finish	48 x 48 x 24	WS131038-#	\$1,060	\$850

The dimensions listed are nominal and represent the closest metric equivalent.
Ex: 48x24 = 1200mm x 600mm, which is slightly smaller.

PCV edge banding is 2mm.

Worksurfaces/Table Tops - Round

Product	Description	Dimensions	Code	CAD	USD
	Worksurface Round LPL Classic White	36 D	WS191031-300	\$205	\$170
	Worksurface Round HPL Woodgrain Specify finish		WS191031-#	\$305	\$250
	Worksurface Round LPL Classic White	42 D	WS191032-300	\$275	\$245
	Worksurface Round HPL Woodgrain Specify finish		WS191032-#	\$450	\$360
	Worksurface Round LPL Classic White	60 D	WS191033-300	\$585	\$480
	Worksurface Round HPL Woodgrain Specify finish		WS191033-#	\$865	\$705

The dimensions listed are nominal and represent the closest metric equivalent.
Ex: 48x24 = 1200mm x 600mm, which is slightly smaller.

PCV edge banding is 2mm.



Motion® Office

soft seating for lounge, meetings, privacy

Acoustics50
 Comfort52

MOTION® STYLES

Meet54
 Expo54
 Arc55
 Wing55
 Loop56

ACCESSORIES & FINISHES

Tables57
 Accessories58
 Backrest Covers59
 Throw Pillows61
 Dimensions62
 Finish Options64
 Fabric Information65

Standard wall materials absorb 3%, MotionOffice has been tested and absorbs 76% of sound waves!

Imagine standing in the middle of a room with all concrete surfaces and one open window, and you blow a loud whistle. The sound that hits the open window passes right through. The sound that hits the concrete surfaces in the room begin to reflect back. The NRC (Noise Reduction Coefficient) of the open window would be 1.00 which is the absence of sound reflection. The NRC of concrete is .03, indicating that 97% of the noise that hits the concrete surfaces will reflect back off the surface. The NRC value of a surface simply denotes its ability to absorb vs reflect sound. The higher the NRC value, the stronger the sound absorption and the lower the sound reflection in the room.

MotionOffice panels have an NRC rating of 0.76 which means that 76% of the sound wave entering into the material will be captured and converted. MotionOffice dramatically contributes to reduction of noise bleed in open plan environments!

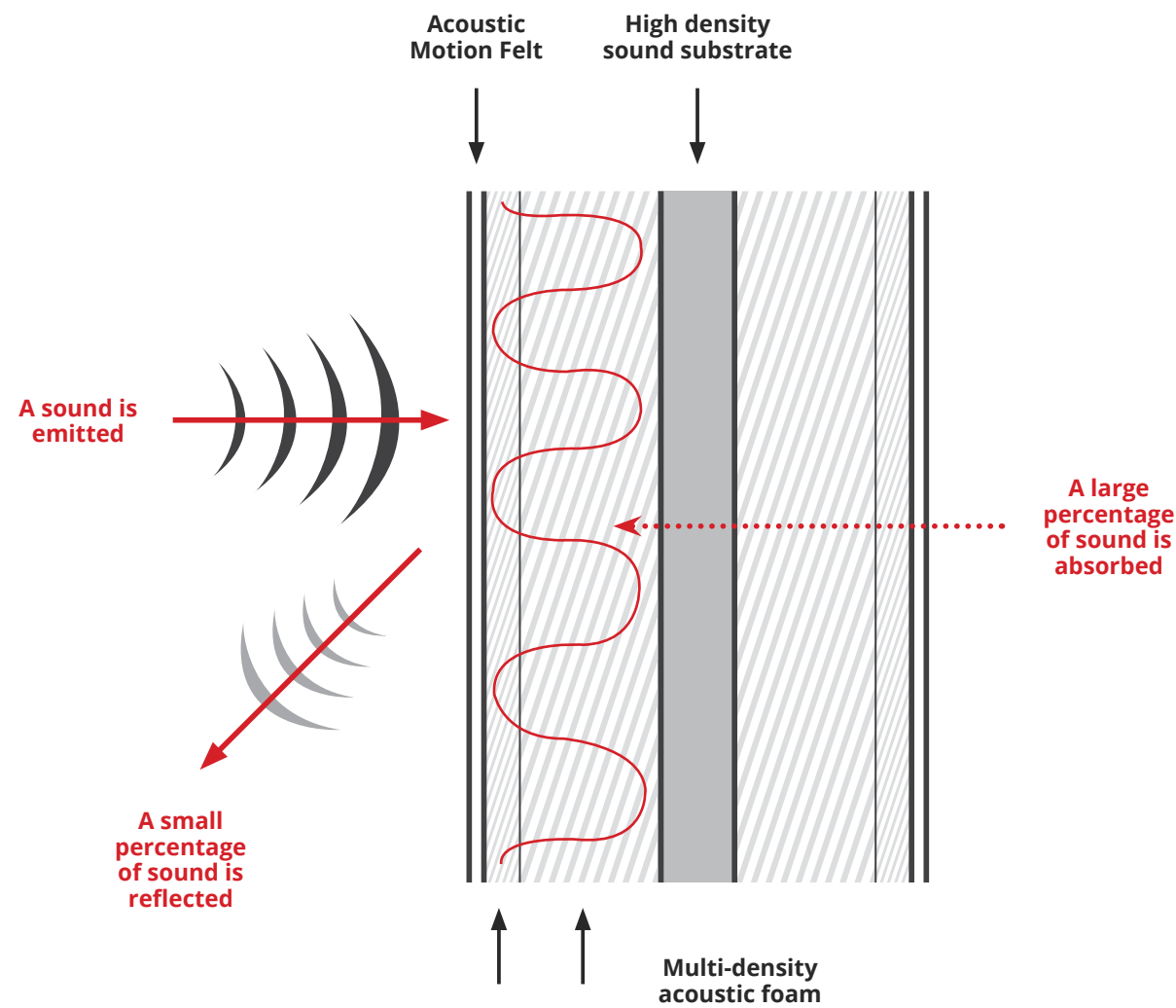

MotionOffice® Acoustics - absorbs 76% of sound waves!

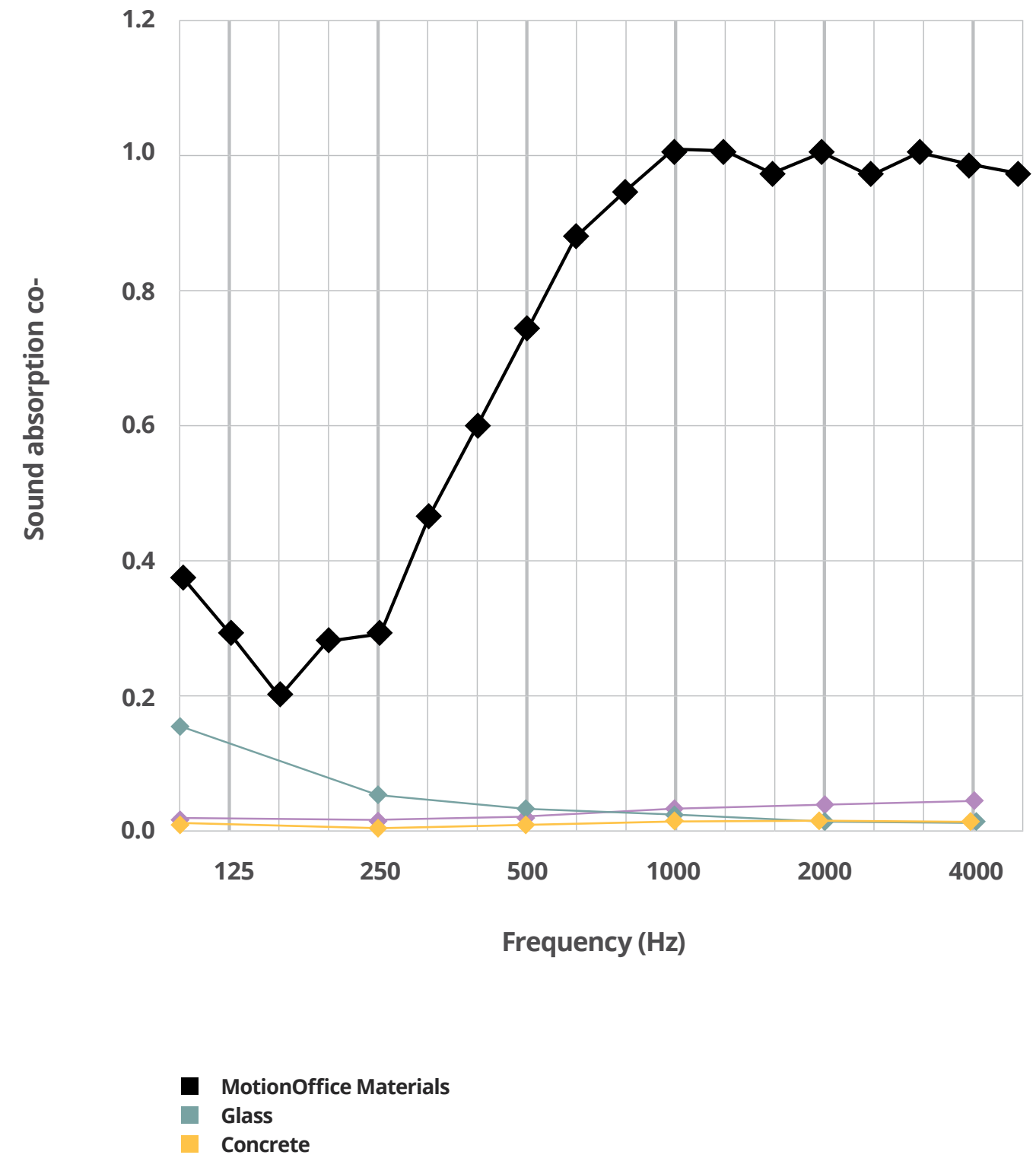

Motion® Office prioritizes comfort, with a multi layered, supportive foundation.

Motion® Office modular seating is built with layers of comfort, for all-day seating that supports the body, naturally.

Motion® modules offer premium comfort with high-resilience foam and pocket springs that give rest and relief to your body – whether you are working, socializing, waiting or just relaxing.

Our comfort promise is backed up with a 10-year warranty. Review the terms in our Warranty document.

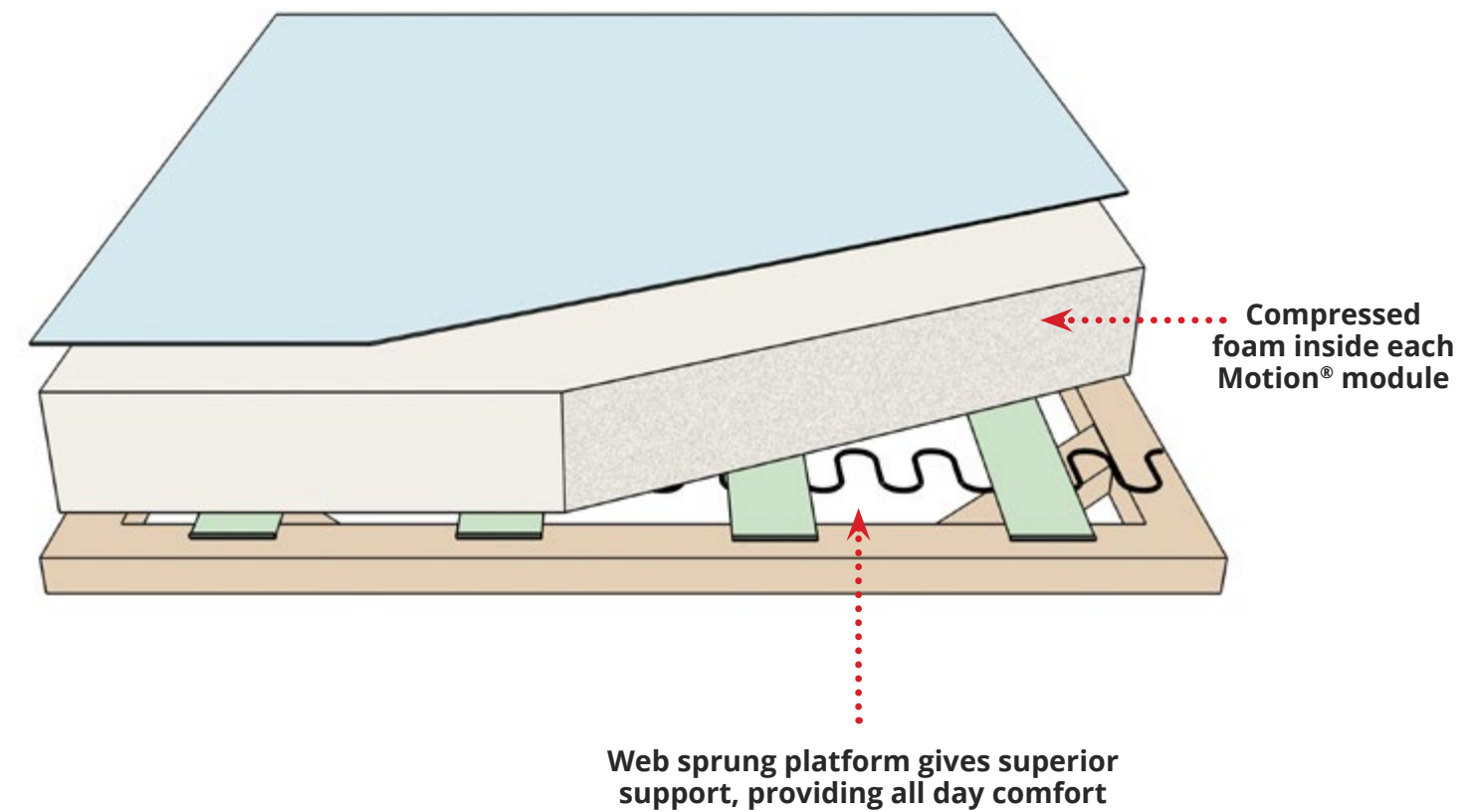

Unlike competitor products where fabric covers foam atop hollow plywood, Motion® Office foam sits on a web sprung platform, supporting the body more effectively and giving greater comfort – especially impactful with long-term sitting.

Collaborative



Backrest Covers

Additional backrest covers can be purchased separately. For code and color options see page 60.



Shown with optional Motion Round Table, see page 57.

Product	Description	Code	CAD	USD
	Motion Meet Charcoal/Stone upholstery Includes Motion Meet Table 60 x 100, with seats and backrests	LPL Classic White / MCPMT4CLST/300	\$14,465	\$14,965
		HPL Specify finish / MCPMT4CLST/####	\$14,635	\$15,080

Product	Description	Code	CAD	USD
	Motion Arc 3 Includes 3x Motion Loop - Curved 60° Outer Back	MARC3/CLST	\$8,375	\$8,680
	Motion Arc 4 Includes 4x Motion Loop - Curved 60° Outer Back	MARC4/CLST	\$11,165	\$11,570
	Motion Arc 5 Includes 5x Motion Loop - Curved 60° Outer Back	MARC5/CLST	\$13,950	\$14,460



Product	Description	Code	CAD	USD
	Motion Expo Charcoal/Stone upholstery	LPL Classic White / MEXPO5CLST/300	\$20,465	\$21,800
		HPL Specify finish / MEXPO5CLST/####	\$20,905	\$22,090

Focus/Solo Work



Backrest Covers

Additional backrest covers can be purchased separately. For code and color options see page 59.

Product	Description	Code	CAD	USD
	Motion Wing 1-Seat, Charcoal/Stone	MWNG1/CLST	\$3,620	\$3,695

Flexible/Lounge



Product	Description	Code	CAD	USD
	Motion Loop - Straight Includes Backrest	MLPS7B/CLST	\$1,630	\$1,685
	Motion Loop - Curved 60° Includes Outside Backrest	MLPC60BO/CLST	\$2,790	\$2,890
	Motion Loop - Curved 60° Includes Inside Backrest	MLPC60BI/CLST	\$2,580	\$2,675
	Motion Loop - Curved 90° Includes Outside Backrest	MLPC90BO/CLST	\$4,485	\$4,650





Tables

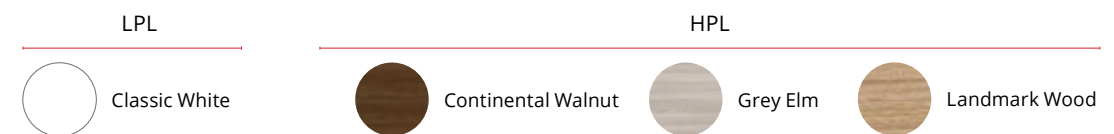

Product	Description	Code	CAD	USD
	Motion Coffee Table - Straight Black Frame Worksurface available in 4 colors See dimensions on page 63.	LPL Classic White / MST75B/300	\$350	\$370
		Continental Walnut / MST75B/8232		
		HPL Grey Elm / MST75B/8201	\$415	\$415
	Motion Coffee Table - Curved Worksurface available in 4 colors Black Frame See dimensions on page 63.	LPL Classic White / MCR60B/300	\$760	\$805
		Continental Walnut / MCR60B/8232		
		HPL Grey Elm / MCR60B/8201	\$870	\$875
	Motion Tablet Table Worksurface available in 4 colors Black Frame See dimensions on page 63.	LPL Classic White / MTABTB/300	\$240	\$250
		Continental Walnut / MTABTB/8232		
		HPL Grey Elm / MTABTB/8201	\$265	\$270
	Motion Round Table - Coffee Height Worksurface available in 4 colors Black Frame - 18" high / 41.3" diameter	LPL Classic White / MRT46B/300	\$675	\$715
		Continental Walnut / MRT46B/8232		
		HPL Grey Elm / MRT46B/8201	\$855	\$830
	Motion Round Table - Sit Height Worksurface available in 4 colors Black Frame - 28.7" high / 41.3" diameter	LPL Classic White / MRT73B/300	\$685	\$720
		Continental Walnut / MRT73B/8232		
		HPL Grey Elm / MRT73B/8201	\$860	\$840
	Motion Round Table - Stand Height Worksurface available in 4 colors Black Frame - 41.3" high / 41.3" diameter	LPL Classic White / MRT105B/300	\$690	\$790
		Continental Walnut / MRT105B/8232		
		HPL Grey Elm / MRT105B/8201	\$870	\$905



Accessories

Product	Description	Code	CAD	USD
	Monitor Bracket Black Powdercoat	MMBRAC/B	\$150	\$160
	Bag/Coat Hook Black Powdercoat	MHOOK/B	\$25	\$25
	Name Plate Black Powdercoat	MNAME/B	\$25	\$30



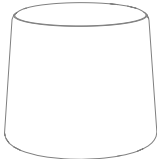





Otto chair

Product	Description	Code	CAD	USD
	Ottoman Includes casters	MOSTOOL_#	\$745	\$900

- Select fabric for Ottoman cover









Motion Felt AS ST CL DB IC EM BB AV SO CR

Backrest Covers - Wing









Product	Description	Code	CAD	USD
	Motion Backrest Cover 25.6" - Ash Suitable for Motion Wing	MBACK06COV/AS	\$190	\$210
	Motion Backrest Cover 25.6" - Ocean Suitable for Motion Wing	MBACK06COV/DB	\$190	\$210
	Motion Backrest Cover 25.6" - Glacier Suitable for Motion Wing	MBACK06COV/IC	\$190	\$210
	Motion Backrest Cover 25.6" - Emerald Suitable for Motion Wing	MBACK06COV/EM	\$190	\$210
	Motion Backrest Cover 25.6" - Honey Suitable for Motion Wing	MBACK06COV/BB	\$190	\$210
	Motion Backrest Cover 25.6" - Avocado Suitable for Motion Wing	MBACK06COV/AV	\$190	\$210
	Motion Backrest Cover 25.6" - Sunset Suitable for Motion Wing	MBACK06COV/SO	\$190	\$210
	Motion Backrest Cover 25.6" - Chilli Red Suitable for Motion Wing	MBACK06COV/CR	179	194

Backrest Covers - Meet

Order Quantity 2 per Motion Meet

Product	Description	Code	CAD	USD
	Motion Backrest Cover 55.1" - Ash Suitable for Motion Meet	MBACK14COV/AS	\$305	\$330
	Motion Backrest Cover 55.1" - Ocean Suitable for Motion Meet	MBACK14COV/DB	\$305	\$330
	Motion Backrest Cover 55.1" - Glacier Suitable for Motion Meet	MBACK14COV/IC	\$305	\$330
	Motion Backrest Cover 55.1" - Emerald Suitable for Motion Meet	MBACK14COV/EM	\$305	\$330
	Motion Backrest Cover 55.1" - Honey Suitable for Motion Meet	MBACK14COV/BB	\$305	\$330
	Motion Backrest Cover 55.1" - Avocado Suitable for Motion Meet	MBACK14COV/AV	\$305	\$330
	Motion Backrest Cover 55.1" - Sunset Suitable for Motion Meet	MBACK14COV/SO	\$305	\$330
	Motion Backrest Cover 55.1" - Chili Suitable for Motion Meet	MBACK14COV/CR	\$305	\$330

Throw Pillows

Product	Description	Code	CAD	USD
	Motion Throw Pillow - Raw <i>*Must order with a throw pillow cover below</i>	MTPILLOW	\$75	\$85
	Motion Throw Pillow Cover - Ash Cover Only	MTPILLOWCOV/AS	\$110	\$115
	Motion Throw Pillow Cover - Ocean Cover Only	MTPILLOWCOV/DB	\$110	\$115
	Motion Throw Pillow Cover - Glacier Cover Only	MTPILLOWCOV/IC	\$110	\$115
	Motion Throw Pillow Cover - Emerald Cover Only	MTPILLOWCOV/EM	\$110	\$115
	Motion Throw Pillow Cover - Honey Cover Only	MTPILLOWCOV/BB	\$110	\$115
	Motion Throw Pillow Cover - Avocado Cover Only	MTPILLOWCOV/AV	\$110	\$115
	Motion Throw Pillow Cover - Sunset Cover Only	MTPILLOWCOV/SO	\$110	\$115
	Motion Throw Pillow Cover - Chili Cover Only	MTPILLOWCOV/CR	\$110	\$115

Product Dimensions

Motion Meet

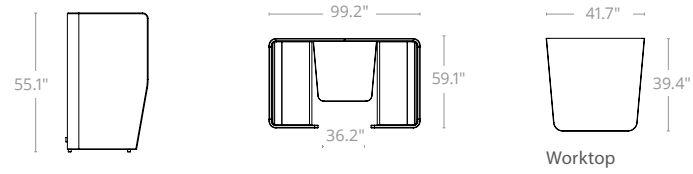

Motion Wing

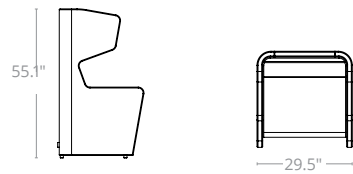

Motion Loop

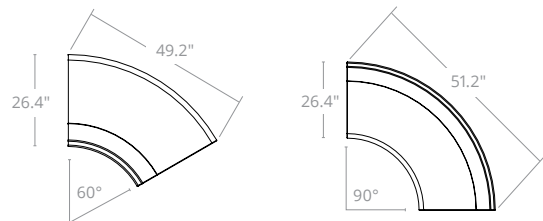
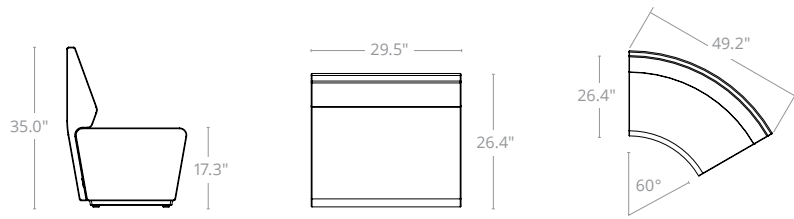

Motion Expo

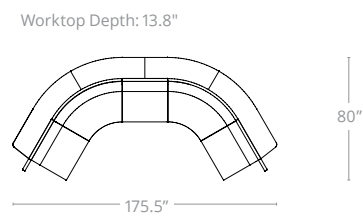

Motion Arc

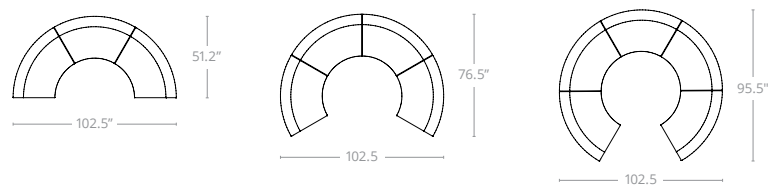

Motion Coffee Table Straight

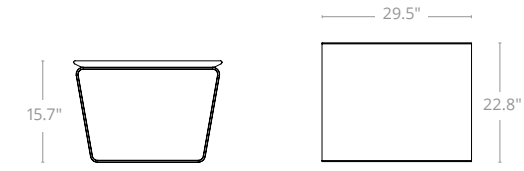

Motion Coffee Table Curved

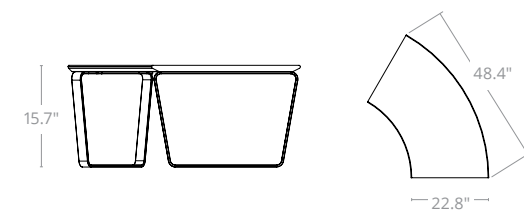

Motion Tablet Table

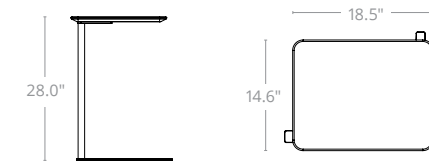

Motion Round Table

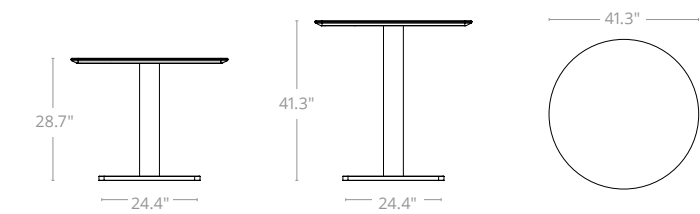

Motion Felt Colors

Plush Collection

Stock Felt Colors

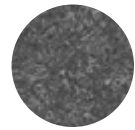

Stone Grey

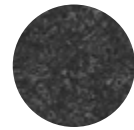

Charcoal Grey

Upgrade Felt Colors (Applies to Meeting and Wing 1 seat backs, Throw Pillows only)

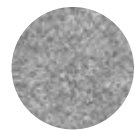

Ash



Honey

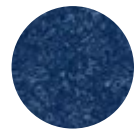

Ocean



Avocado



Ice



Sunset

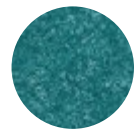

Emerald



Chili

Motion Worksurface Colors

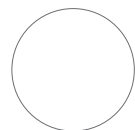

Classic White



Grey Elm



Continental Walnut



Landmark Wood

Fabric Information

Motion Felt is a wool blend textile with a soft hand and contemporary color-ways that will add a subtle, elegant distinction to larger, upholstered furniture items.

Motion Felt is yarn dyed and has been milled to give it a direction-less felted appearance. The milling process also increases the inherent durability and water repellent properties, which along with the natural flame resistant properties of wool, makes this fabric very suitable for heavy commercial use.

Technical Specifications

Type:	Upholstery
Composition:	50% Wool 50% Polyester
Weight:	750g/lin.m
Roll Width:	150cm
Repeat:	None
Abrasion:	100,000 rubs (Martindale)
Pilling:	4-5, BS EN ISO 12945-2:2000
Light Fastness:	4-5, BS EN ISO 105-B02
Flammability:	BS EN 1021.1 (cigarette) BS EN 1021.2 (match) CAL TB 117-2013
Color Matching:	Batch to batch variations in color may occur within commercial tolerances

Maintenance & Cleaning

Wool is naturally anti-static and water repellent making it less likely to attract dirt and absorb spillages. It is important to keep the fabric clean as this will extend the life of the fabric and preserve its fire retardant properties. Frequent (weekly) vacuuming on low suction is advised to remove dust and loose soiling. Under normal commercial use we recommend cleaning 1-3 times yearly by a professional dry cleaning service. It is important to protect the fabric from direct and refracted sunlight as this will ensure that the fabric retains its original color.

Spot Cleaning

Soiling should be acted on immediately to prevent lasting damage to the fabric. We always recommend testing stain removal detergents and solvents on an inconspicuous area first.

- Immediately absorb any liquids with an absorbent cloth.
- Scrape off any solidified material with a spoon.
- Remove loose material with a vacuum cleaner on low power.
- Wipe clean with a damp cloth using pH-neutral upholstery shampoo (follow directions on packaging). Do not scrub or use a stiff brush.
- Use clean water without any cleaning product for the final clean.
- Do not use dish washing or laundry detergents. Do not use detergents, bleach, ammonia or soap intended for hard surfaces.
- Dry with a clean white cloth using a circular dabbing motion to avoid edge marks. Use of hair dryer may also help avoid edge marks.
- Allow to dry thoroughly before reusing.

This is intended as a guide only. We recommend consultation with a fabric care professional.

Environmental

As a caring, corporate citizen, we support the responsible stewardship of the earth, its inhabitants and its resources.

Our fabrics are designed and made to last, and in their manufacture, use and disposal, embody the environmental principles of Reduce, Reuse & Recycle.

Fire retardants are bromide free.

Dyes are free from heavy metals.



Seating

- Essence 68
- Compass..... 68
- Otto..... 69
- Balance Executive..... 70
- Balance..... 71
- Radius..... 71
- Mode 72
- Metro (Canada only)..... 73
- Luna 74

Essence Task

Product	Description	Code	CAD	USD
	Essence, Black Black frame and base Black mesh back Umbra Charcoal fabric seat Adjustable arms	ESS/BCB	\$900	\$650
	Essence, White White frame and base Grey mesh back Umbra Ash fabric seat Adjustable arms	ESS/GGW		

Compass Task

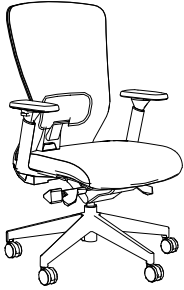
Product	Description	Code	CAD	USD
	Compass, Black Black frame Chrome base Black mesh back Umbra Charcoal fabric seat Adjustable arms Adjustable lumbar	COML/BCB	\$1,215	\$890
	Compass, White White frame Chrome base Grey mesh back Umbra Ash fabric seat Adjustable arms Adjustable lumbar	COML/GGW		

Seat covers

Umbra Collection AS CL

Please note:

All Essence and Compass seating come standard with hardfloor casters.

Otto

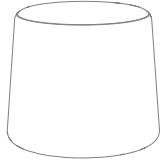
Product	Description	Code	CAD	USD
	Ottoman Includes casters Select from colors, below.	MOSTOOL_#	\$745	\$900





- Select fabric for Ottoman cover

Motion Felt AS ST CL DB IC EM BB AV SO CR

Please note:

All seating products require partial assembly, except the Otto stool.



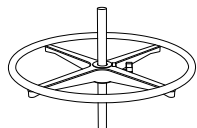
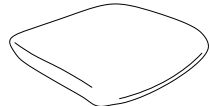

Balance Executive

Product	Description	Code	CAD	USD
	Balance Executive Chair Black faux leather seat Polished alloy base Adjustable arms	BALM/PU	\$930	\$940
	Balance Executive Chair White faux leather seat Polished alloy base Adjustable arms	BALM/WPU		
	Balance Executive Chair with Headrest Black faux leather seat Polished alloy base Adjustable arms Headrest	BALH/PU	\$930	\$940
	Balance Executive Chair with Lumbar Support Mesh back Faux leather seat Polished alloy base Lumbar support, Black	BALML/PU	\$930	\$940
	Upgrade Hardfloor caster Set of 5 casters	SOFTCAST	\$35	\$30
	Upgrade Chrome footring Bar height	BH_UP	\$290	\$295
	Upgrade Breathe fabric seat cover	BALMCOV/BR#	\$65	\$65

- Select fabric - Seat covers

- Breathe B BL G LG O R T

Balance Seating

Product	Description	Code	CAD	USD
	Balance Guest Black frame Black mesh backrest Black fabric seat Fixed arms	BALV/BF	\$610	\$625
	Balance Training w/ Arms Black frame Black mesh backrest Black fabric seat Fixed arms	BALVA/BF	\$690	\$705
	Balance Training, Armless Black frame Black mesh backrest Black fabric seat	BALVNA/BF	\$690	\$705
	Upgrade - Balance Task/Training Hardfloor caster Set of 5 casters	SOFTCAST	\$35	\$30





Radius Seating

Product	Description	Code	CAD	USD
	Radius, Black Black frame Umbra black mesh back / lumbar support Black fabric seat 3-way adjustable armrests Seat depth and tilt adjustments	RADB/B	\$900	\$675
	Radius, White White frame Umbra ash mesh back / lumbar support 3-way adjustable armrests Adjustable lumbar support Seat depth and tilt adjustments	RADW/G	\$995	\$745



Please note:
All seating on this page have seat covers which are not removable.
All seating products require partial assembly, except the Otto stool.





Mode

Product	Description	Code	CAD	USD
	Highback Black faux leather seat	MODH/PU	\$845	\$875
	Highback White faux leather seat	MODH/WPU		
	Midback Black faux leather seat	MODM/PU	\$785	\$790
	Midback White faux leather seat	MODM/WPU		
	Guest Black faux leather seat	MODV/PU	\$785	\$790
	Guest White faux leather seat	MODV/WPU		
	Boardroom Black faux leather seat	MODMB/PU	\$785	\$790
	Boardroom White faux leather seat	MODMB/WPU		
	Upgrade Hardfloor caster set of 5 casters	SOFTCAST	\$35	\$30

Please note:

Armrest covers are included in the price of the Mode chair.
All seating products require partial assembly, except the Otto stool.

Metro Sold in Canada only

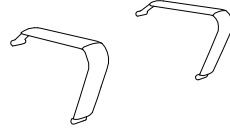

Product	Description	Code	CAD	USD
	Highback Black faux leather seat	METH/PU	\$855	N/A
	Highback White faux leather seat	METH/WPU		
	Midback Black faux leather seat	METM/PU	\$800	N/A
	Midback White faux leather seat	METM/WPU		
	Guest Black faux leather seat	METV/PU	\$585	N/A
	Guest White faux leather seat	METV/WPU		
	Boardroom Black faux leather seat	METMB/PU	\$800	N/A
	Boardroom White faux leather seat	METMB/WPU		
	Upgrade Hardfloor caster Set of 5 casters	SOFTCAST	\$35	N/A
	Upgrade Zipped arm cover Black leather	MARMCOV/B	\$60	N/A
	Upgrade Zipped arm cover White leather	MARMCOV/W		

Not available in the U.S.

Please note:

All seating products require partial assembly, except the Otto stool.

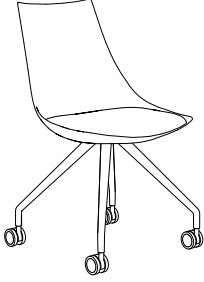
Luna

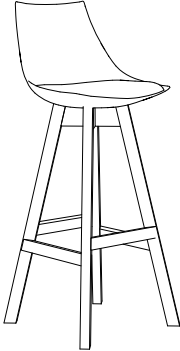





Product	Description	Code	CAD	USD
	Luna Chair Caster base Black shell Upholstered cushion	LUNAB_CAS/##	\$565	\$570
	Luna Chair Caster base White shell Upholstered cushion	LUNAW_CAS/##	\$565	\$570
	Luna Chair Oak base Black shell Upholstered cushion	LUNAB_OAK/##	\$585	\$595
	Luna Chair Oak base White shell Upholstered cushion	LUNAW_OAK/##	\$585	\$595
	Luna Barstool Oak base Black shell Upholstered cushion	LUNAB_BAR/##	\$650	\$665
	Luna Barstool Oak base White shell Upholstered cushion	LUNAW_BAR/##	\$650	\$665

Please note:
All seating products require partial assembly, except the Otto stool.

- Select fabric - upholstered cushion

- Motion Felt
- AS
- ST
- CL
- DB
- IC
- EM
- BB
- AV
- SO
- CR
- Eurotex PU
- B
- W

Game

Product	Description	Code	CAD	USD
	Game Barstool Chrome frame Charcoal shell	GMBSRSCN	\$385	\$395
	Game Barstool Chrome frame Charcoal shell Upholstered seat	GMBSRSCS/B#	\$425	\$430
	Game Barstool Chrome frame Charcoal shell Upholstered seat + backrest	GMBSRSCF/B#	\$445	\$455
	Game Chair 4 Leg Chrome Charcoal shell	GM4LRSCN	\$275	\$280
	Game Chair 4 Leg Chrome Charcoal shell Upholstered seat	GM4LRSCS/B#	\$310	\$315
	Game Chair 4 Leg Chrome Charcoal shell Upholstered seat + backrest	GM4LRSCF/B#	\$335	\$340

Please note:
All seating products require partial assembly, except the Otto stool.

- Select fabric - upholstered cushion(s)

- Breathe
- SB
- B
- SG
- LG
- BRO
- TR
- PL



Tables

Modulus (frames only)

Modulus Overview..... 78

Modulus Flip..... 82

Modulus Fixed Tables..... 83

Modulus Collar Leg 85

Modulus Accessories 88

Axis (frames only)

Axis Tables Overview 90

Axis Tables 92

Axis Bar Leaners 93

NOTE
 For table tops, see Worksurfaces, pages 42-47

Modulus Flip

- Frames:** Black Matte, Silver or Arctic White Powdercoat finish to the posts, rails & pull bars
Polished alloy feet
- Worksurfaces:** 1" M2 Grade substrate
Studio White Melamine finish
Matching 2mm PVC edge
- Features:** Swiveling lockable casters
Strong flip mechanism has safety stay upright locks

Flip - Small

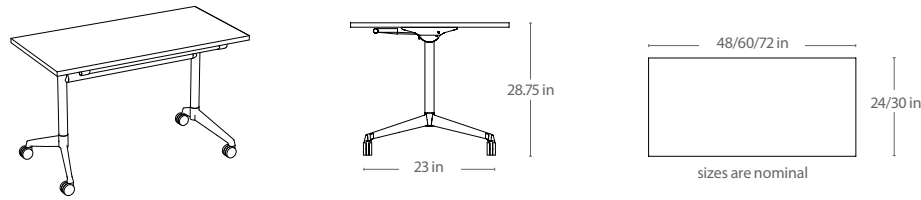

Flip - Large

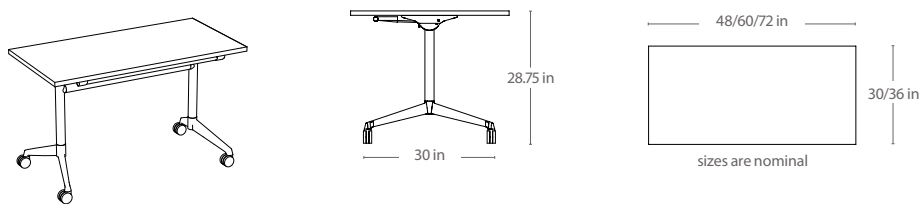

Additional Frame Details

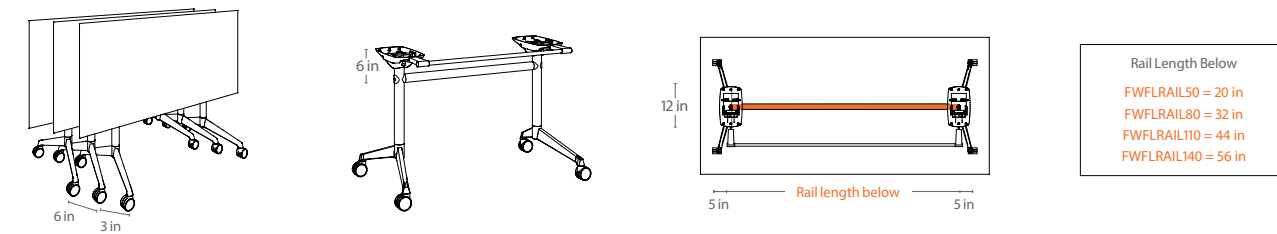

Modulus Fixed Leg

- Frames:** Black Matte Powdercoat finish to all posts & rails
Polished alloy feet and worktop supports
- Worksurfaces:** 1" M2 Grade substrate
Studio White Melamine finish
Matching 2mm PVC edge
- Features:** Leveling glides

Fixed Leg - Small

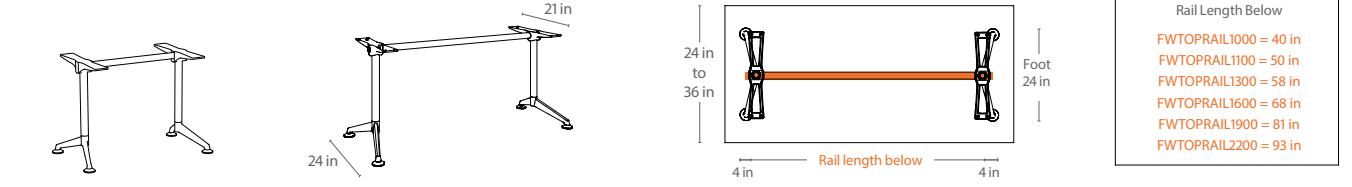

Fixed Leg - Wide

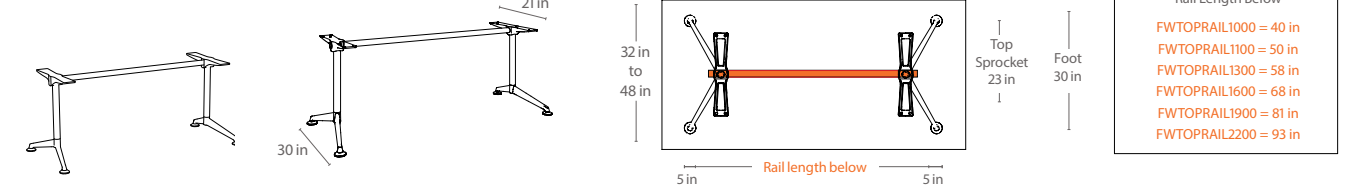

Modulus Collar Leg

- Frames:**
 - Black Matte Powdercoat finish to all posts & rails
 - Polished alloy feet and worktop supports
- Worksurfaces:**
 - 1" M2 Grade substrate
 - Studio White Melamine finish
 - Matching 2mm PVC edge
- Features:**
 - Leveling glides

Collar Leg - Twin Post

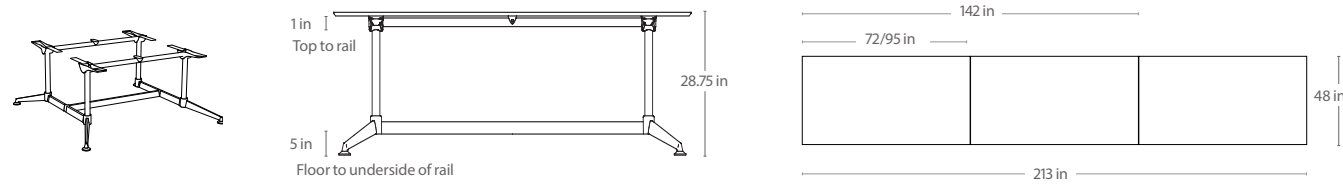

Additional Frame Details

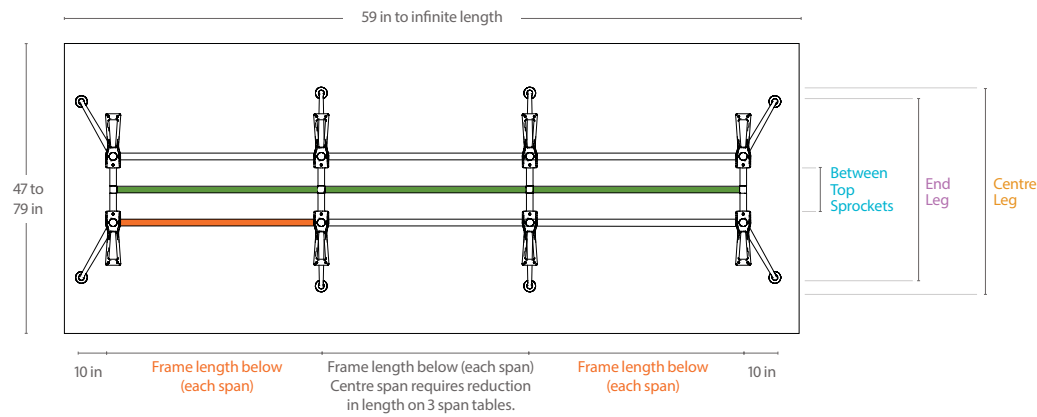

Top rail length (each span) Two beams per span	Lower beam length (each span) One beam per span	Leg Width Kit	End Leg	Centre Leg	Between Top Sprockets Alloy
FWTOPRAIL1100 = 49 in	FWBOTRAIL1100 = 43 in	FW1200	48 in	50 in	7 in
FWTOPRAIL1300 = 57 in	FWBOTRAIL1300 = 51 in	FW1400	55 in	54 in	12 in
FWTOPRAIL1600 = 69 in	FWBOTRAIL1600 = 63 in	FW1600	57 in	62 in	19 in
FWTOPRAIL1900 = 81 in	FWBOTRAIL1900 = 75 in	FW1800	66 in	70 in	27 in
FWTOPRAIL2200 = 93 in	FWBOTRAIL2200 = 87 in				

Component Breakdown

Stockcode/Packs	Description	Quantity
FWMOD-04END_B	Twin Post End Leg Pair with Collar	1
FW1800SET_B	Width Connector Beam	2
FWMOD-04MID_B	Twin Post Centre Leg with Collar	2
FWTOPRAIL1600_B	Upper Rails	6
FWBOTRAIL1600_B	Lower Beam Set	3

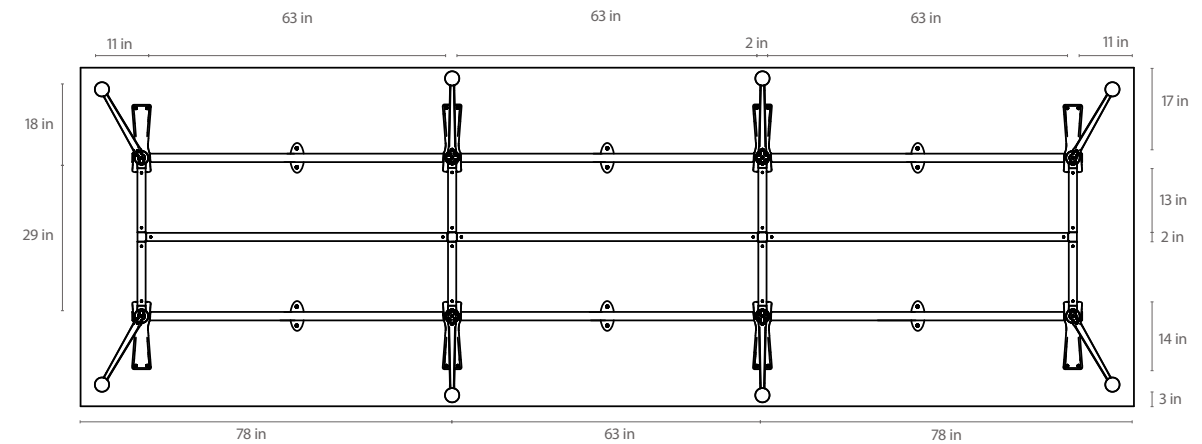
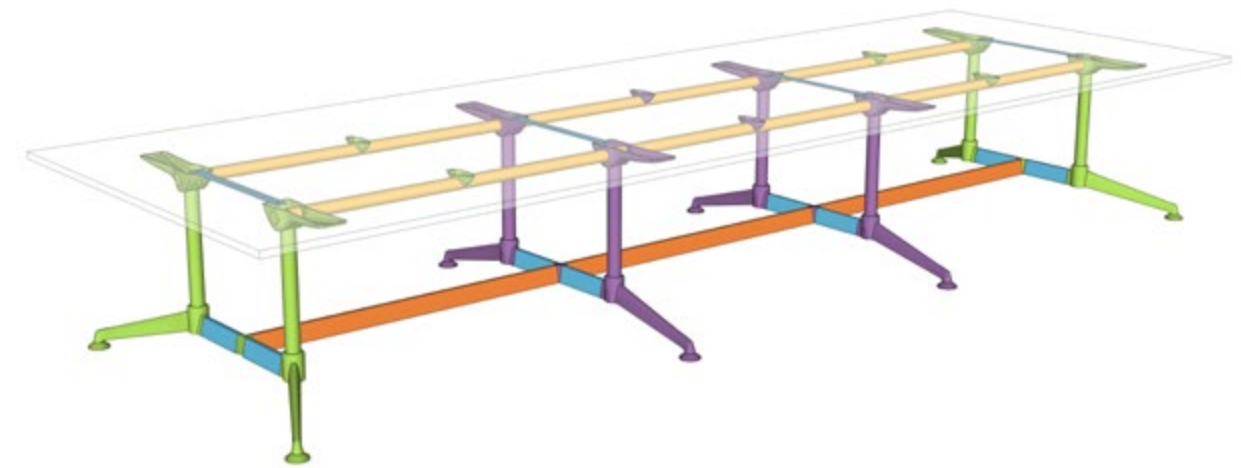

Modulus Flip

Frame only

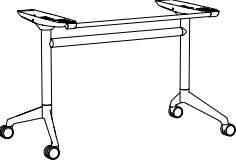
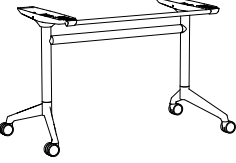
Product	Description	Suits Worktop Length	Code	CAD	USD
	Flip table frame, Standard Suits worksurface depth 24 - 36" Specify White, Silver or Black frame color	36" - 48"	MFLIP050/#F	\$740	\$710
		48" - 60"	MFLIP080/#F	\$760	\$730
		60" - 72"	MFLIP110/#F	\$780	\$750
		72" - 84"	MFLIP140/#F	\$810	\$775
	Flip table frame, Large Suits worksurface depth 30" - 42" Specify White, Silver or Black frame color	36" - 48"	MFLIPL050/#F	\$895	\$855
		48" - 60"	MFLIPL080/#F	\$915	\$875
		60" - 72"	MFLIPL110/#F	\$935	\$895
		72" - 84"	MFLIPL140/#F	\$965	\$920

@ - Select modesty finish

Powdercoat **B** S W

Modulus Tables

Frame only

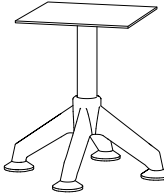
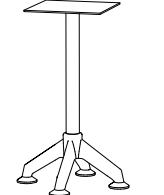
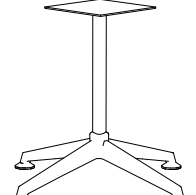
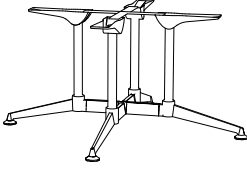
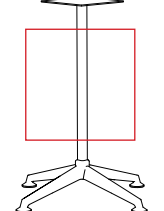
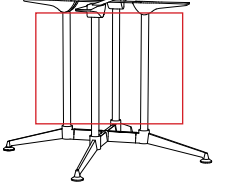
Product	Description	Suits Worktop Size	Code	CAD	USD
	Meeting table frame Frame height: 17" Polished aluminum feet	16"-28" round 16"-24" square	CA-FWMOD11.16R/BF	\$355	\$340
	Meeting table frame Frame height: 27.75" Polished aluminum feet	16"-28" round 16"-24" square	CA-FWMOD11.15R/BF	\$355	\$340
	Meeting table frame Frame height: 27.75" Polished aluminum feet	32"-48" round 28"-39" square	CA-FWMOD11.1R/BF	\$460	\$440
	Meeting table frame Frame height: 27.75" Polished aluminum feet	54"-72" round 48"-66" square	CA-FWMOD11.2R/BF	\$1,335	\$1,280
	Upgrade Bar-height poles Suitable for: Single post pedestal base	Frame height 41" High	MODZA22-808	\$145	\$140
	Upgrade Bar-height poles Suitable for: 4 post pedestal base	Frame height 41" High	MODZA22-758	\$75	\$75

*Price is per pole

Modulus Tables

Fixed leg - frame only

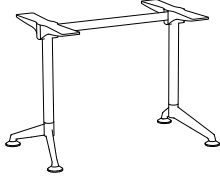
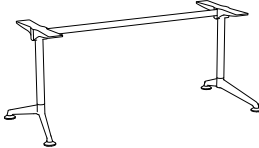
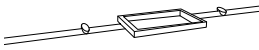
Product	Description	Suits Worktop Length	Code	CAD	USD
	Meeting table frame Small fixed leg Suits worksurface depth of 24"-30" Black frame	48"-54"	MT1206F/BF	\$695	\$670
		54"-72"	MT1406F/BF	\$700	\$670
		66"-84"	MT1606F/BF	\$720	\$690
	Meeting table frame Large fixed leg Suits worksurface depth of 30"-36" Black frame	48"-54"	MT1208F/BF	\$705	\$675
		54"-72"	MT1408F/BF	\$720	\$690
		66"-84"	MT1608F/BF	\$745	\$710
	Upgrade 92.5" Long post for single post tables to accommodate power module Black Suits powerboxes up to 20" x 12" Note: Can be cut down to suit shorter tops		FWTOPRAILP-BOX2200	\$415	\$395

Modulus Tables

Collar leg - frame only

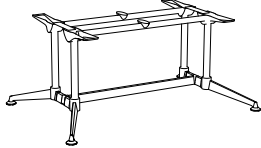
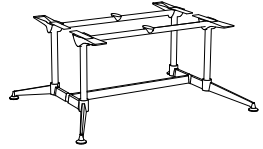
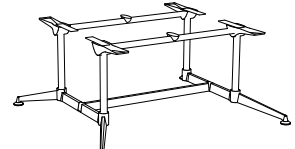
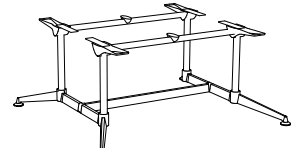
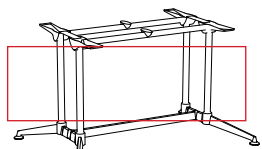
Product	Description	Suits Worktop Length	Code	CAD	USD
	Meeting table frame Single span Suits worksurface width of 48"-54"	66"-84"	MT1412CC/BF	\$1,730	\$1,655
		72"-96"	MT1612CC/BF	\$1,730	\$1,655
	Meeting table frame Single span Suits worksurface width of 55"-62"	66"-84"	MT1414CC/BF	\$1,750	\$1,675
		72"-96"	MT1614CC/BF	\$1,750	\$1,675
	Meeting table frame Single span Suits worksurface width of 64"-69"	66"-84"	MT1416CC/BF	\$1,780	\$1,705
		72"-96"	MT1616CC/BF	\$1,780	\$1,705
	Meeting table frame Single span Suits worksurface width of 72"-79"	66"-84"	MT1418CC/BF	\$1,785	\$1,710
		72"-96"	MT1618CC/BF	\$1,820	\$1,740
	Upgrade * Bar-height poles Twin pole/four pole Pedestal base	Modulus Meeting Table Bar Height Poles, for 4-post pedestal base, each, 41 H, Black	MODZA22-758	\$75	\$75
		Modulus Meeting Table Bar Height Poles, for 1-post pedestal base, each, 41 H, Black	MODZA22-808	\$145	\$140

*Price is per pole, order qty will depend on the size of the base.

STANDARD WORKTOP SIZES

- | | | |
|----------------------|-----------------|-----------------|
| Single Piece Worktop | 2-Piece Worktop | 3-Piece Worktop |
| • 72" x 48" | • 120" x 48" | • 213" x 48" |
| • 96" x 48" | • 142" x 48" | |

Modulus Tables



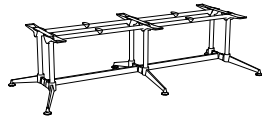
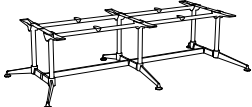
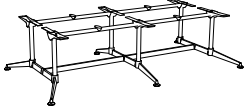
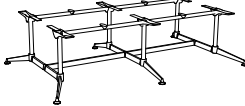
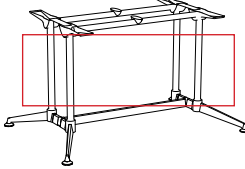

Collar leg - frame only

Product	Description	Suits Worktop Length	Code	CAD	USD
	Meeting table frame Double Span Suits worksurface depth of 48"-54" Black frame	120"-132"	MT2612CC2/BF	\$2,655	\$2,540
		132"-144"	MT3012CC2/BF	\$2,720	\$2,605
		156"-168"	MT3612CC2/BF	\$2,840	\$2,725
		204"-216"	MT4812CC2/BF	\$3,050	\$2,920
	Meeting table frame Double Span Suits worksurface depth of 55"-62" Black frame	120"-132"	MT2614CC2/BF	\$2,685	\$2,570
		132"-144"	MT3014CC2/BF	\$2,750	\$2,635
		156"-168"	MT3614CC2/BF	\$2,885	\$2,765
		204"-216"	MT4814CC2/BF	\$3,075	\$2,950
	Meeting table frame Double Span Suits worksurface depth of 64"-69" Black frame	120"-132"	MT2616CC2/BF	\$2,735	\$2,615
		132"-144"	MT3016CC2/BF	\$2,800	\$2,680
		156"-168"	MT3616CC2/BF	\$2,930	\$2,810
		204"-216"	MT4816CC2/BF	\$3,075	\$2,950
	Meeting table frame Double Span Suits worksurface depth of 72"-84" Black frame	120"-132"	MT2618CC2/BF	\$2,785	2493
		132"-144"	MT3018CC2/BF	\$2,850	\$2,730
		156"-168"	MT3618CC2/BF	\$3,680	\$3,525
		204"-216"	MT4818CC2/BF	\$3,180	\$3,045
	Upgrade Bar-height poles Twin pole/Four pole Pedestal base Black	41" High	MODZA22-758	\$75	\$75

*Price is per pole, order qty will depend on the size of the base.

Modulus Tables



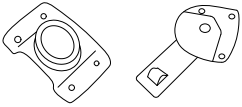
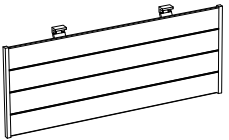
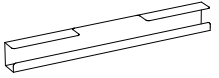

Collar leg - frame only

Product	Description	Suits Worktop Length	Code	CAD	USD
	Meeting table frame Triple Span Suits worksurface depth of 48"-54" Black frame	156"-180"	MT3712CC3/BF	\$3,580	\$3,430
		180"-204"	MT4312CC3/BF	\$3,680	\$3,525
		216"-232"	MT5512CC3/BF	\$3,900	\$3,740
		288"-300"	MT7012CC3/BF	\$4,865	\$4,660
	Meeting table frame Triple Span Suits worksurface depth of 54"-60" Black frame	156"-180"	MT3714CC3/BF	\$3,490	\$3,350
		180"-204"	MT4314CC3/BF	\$3,775	\$3,615
		216"-232"	MT5414CC3/BF	\$3,875	\$3,715
		288"-300"	MT7014CC3/BF	\$4,900	\$4,695
	Meeting table frame Triple Span Suits worksurface depth of 64"-69" Black frame	156"-180"	MT3716CC3/BF	\$3,685	\$3,530
		180"-204"	MT4316CC3/BF	\$3,790	\$3,635
		216"-232"	MT5216CC3/BF	\$3,940	\$3,775
		288"-300"	MT7016CC3/BF	\$4,965	\$4,755
	Meeting table frame Triple Span Suits worksurface depth of 72"-84" Black frame	156"-180"	MT3718CC3/BF	\$3,810	\$3,650
		180"-204"	MT4318CC3/BF	\$3,850	\$3,690
		216"-232"	MT5418CC3/BF	\$3,735	\$3,285
		288"-300"	MT7018CC3/BF	\$5,040	\$4,825

Modulus Flip Accessories

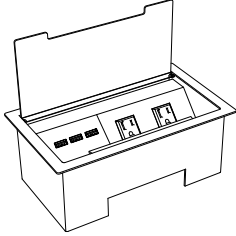
Product	Description	Worktop	Code	CAD	USD
	Accessories Flip table link		GANGMECH/B	\$70	\$65
	Accessories Modesty kit Powdercoat Specify Silver or White	Suits top size 48" 31"w x 14"h	MFMOD125/#	\$255	\$245
		Suits top size 60" 43"w x 14"h	MFMOD145/#	\$350	\$340
		Suits top size 72" 55"w x 14"h	MFMOD165/#	\$450	\$430
	Upgrade Cable tray 36" Length Undermount <i>Note: Fits 60"/72"W and 30"D tables only</i>		ELECTRAY900/W	\$220	\$205

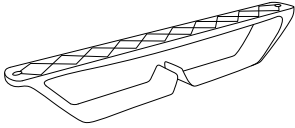
Modulus Accessories

Product	Description	Code	CAD	USD
	Power module White Includes 2 power outlets, 3 Cat6 RJ45 data outlets 108" cord length Custom telecom outlets available	ACT-21/GW-108	\$955	\$915
	Cable cobra Black Power/data segregation	CABCOBRA/B	\$95	\$95
	Cable clutch White Below desk cable management Set of 5	CABCLUTCH_W	\$45	\$45
	Upgrade 92.5" post for single post tables to accommodate power module Black matte Suits power boxes up to 20" x 12" <i>Note: Can be cut down to suit shorter tops</i>	FWTOPRAILP-BOX2200	\$415	\$395

@ - Select modesty finish

Powdercoat S W

Axis Tables

Frames:

Silver or Arctic White
Powdercoat finish to all
posts and rails

Worksurfaces:

1" M2 Grade substrate
Studio White Melamine finish
Matching 2mm PVC edge

Coffee Table

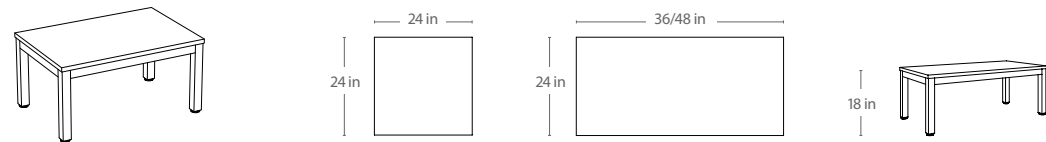

Meeting Table

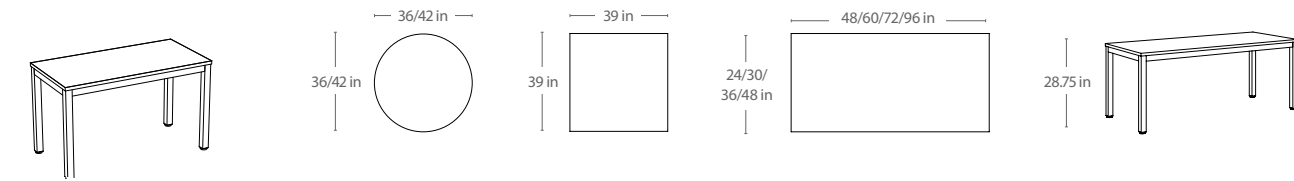

* All dimensions are nominal

Axis Bar Leaner

Frames:

Black Matte or Arctic White
Powdercoat finish to all
posts and rails

Worksurfaces:

1" M2 Grade substrate
Studio White Melamine finish
Matching 2mm PVC edge

Bar Leaner

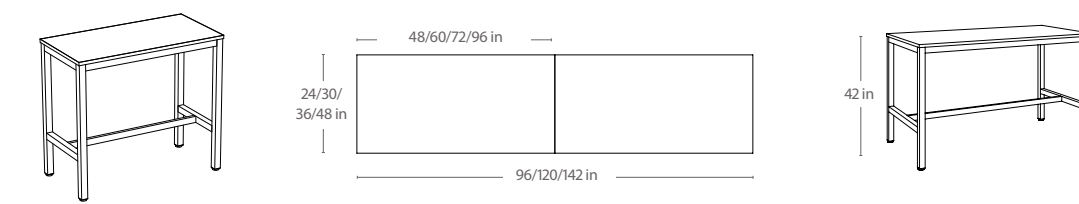

* All dimensions are nominal

Axis Tables

Frame only

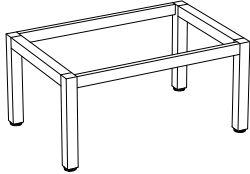
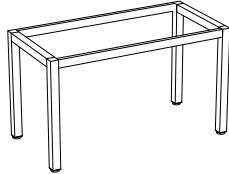
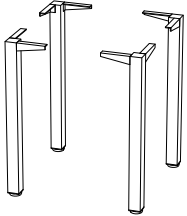
Product	Description	Worktop	Code	CAD	USD
	Coffee table frame Axis Coffee Table Frame, Silver, 18 H	24" x 24"	AXCT66/#F	\$385	403
		36" x 24"	AXCT96/#F	\$420	\$400
		48" x 24"	AXCT126/#F	\$445	\$425
	Meeting table frame rectangle 28.75" height	48" x 24"	AXT126/#F	\$530	\$510
		60" x 24"	AXT156/#F	\$565	\$545
		72" x 24"	AXT186/#F	\$595	\$570
		48" x 30"	AXT1275/#F	\$550	\$530
		60" x 30"	AXT1575/#F	\$585	\$560
		72" x 30"	AXT1875/#F	\$615	\$590
		72" x 36"	AXT189/#F	\$630	\$605
		60" x 48"	AXT1512/#F	\$855	\$820
		72" x 48"	AXT1812/#F	\$655	\$630
		96" x 48"	AXT2412/#F	\$700	\$670
		96" x 48" (Inset legs)	AXT2412I/#F	\$700	\$670
	Meeting Table Legs Set of 4 28.75" H Silver or White For round, rectangle and square table tops	Works with: • Round worksurface up to 60" diameter • Rectangle worksurfaces up to 48"x24" • Square worksurfaces up to 39"x39"	AXLEGMT12-US/#F	\$305	\$290

- Select frame finish

Powdercoat S W

Axis Bar Leaner

Frame only

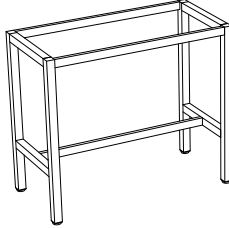
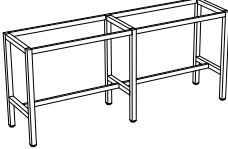
Product	Description	Worktop	Code	CAD	USD
	Bar leaner, frame Single span Specify Black or White	48" x 24"	AXBL1260/#F	\$735	\$705
		60" x 24"	AXBL1560/#F	\$755	\$725
		72" x 24"	AXBL1860/#F	\$780	\$745
		48" x 30"	AXBL1275/#F	\$800	\$770
		60" x 30"	AXBL1575/#F	\$815	\$780
		72" x 30"	AXBL1875/#F	\$835	\$800
		72" x 36"	AXBL1890/#F	\$875	\$840
		60" x 48"	AXBL1512/#F	\$875	\$835
		72" x 48"	AXBL1812/#F	\$915	\$875
		96" x 48"	AXBL2412/#F	\$1,020	\$980
		96" x 24"	AXBL2460/#F	\$1,320	\$1,265
		120" x 24"	AXBL3060/#F	\$1,410	\$1,350
		142" x 24"	AXBL3660/#F	\$1,480	\$1,420
		96" x 30"	AXBL2475/#F	\$1,355	\$1,300
	Bar leaner, frame Double span Specify Black or White	120" x 30"	AXBL3075/#F	\$1,445	\$1,390
		142" x 30"	AXBL3675/#F	\$1,515	\$1,455
		142" x 36"	AXBL3690/#F	\$1,575	\$1,510
		120" x 48"	AXBL3012/#F	\$1,550	\$1,485
		142" x 48"	AXBL3612/#F	\$1,635	\$1,565

- Select finishes

Powdercoat B W



Storage & Reception







Storage

- Milo metal storage96
- Mochi undermount98
- Overhead Hutch.....99

Reception

- Reception Counters 100

Milo Metal Storage

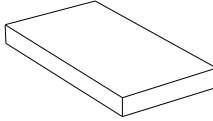
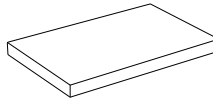
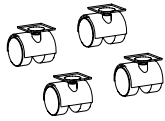
Product	Description	Dimensions	Code	CAD	USD
	Milo 12" Mobile BF Pedestal Metal, Box-File, 12"W Casters installed (2 locking) Specify Black, White or Silver Optional cushion top	21.3"h x 12"w x 23"d	MOBF12/#	\$610	\$520
	Milo 15" BBF Pedestal Metal, BBF, 15" W Specify Black, White or Silver Casters (4, 2 locking) included	27.3"h x 15"w x 23"d	MOBBF15/#	\$660	\$565
	Milo 1.5-Drawer Lateral File Metal, 1.5 drawer, 30" W Specify Black, White or Silver Optional cushion top Casters (4, with 2 locking) included	20h x 30w x 20d	MOLAF1530/#	\$1,255	\$935
	Milo Bookcase Milo Bookcase, Metal, 1.5H shelf, 30 W Specify Black, White or Silver Optional cushion top Casters (4, with 2 locking) included	20"h x 30"w x 20"d	MOBK1530/#	\$910	\$775
	Milo 2-Drawer Lateral File Metal, 2 drawer, 30" W Specify Black, White or Silver Optional cushion top Casters (4, with 2 locking) included	30"h x 30"w x 20"d	MOLAF230/#	\$1,335	\$995
	Milo 2-Door Cabinet Metal, 2 door, 30" W Specify Black, White or Silver Optional cushion top Casters (4, with 2 locking) included	30"h x 30"w x 20"d	MOCAB230/#	\$1,195	\$890
	Milo Cushion Top for 12" BF Mobile Pedestal Milo Seat Cushion with Cover Specify color from Plush collection.		MOSEAT12/#	\$190	\$160
	Milo Cushion Top for 30" Lateral Files, Cabinet and Bookcase Specify color from Plush collection.		MOSEAT30/#	\$255	\$220
	Milo Casters, extra set of 4 Two of four casters are locking.		MOCAS	\$100	\$85



- Select Metal finish # - Select felt - Plush Collection Cushion Top

B
 S
 W

CR Chili
 CL Charcoal
 ST Stone
 AS Ash
 NA Natural
 BB Honey
 AV Avocado
 DB Ocean

Mochi Undermount Personal Storage

Specify: MCHU- AS LH / B

Mochi PET wrap color Right or Left handed Handle finish

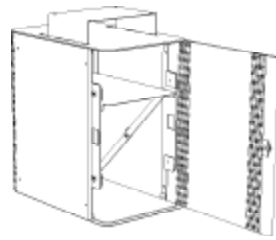
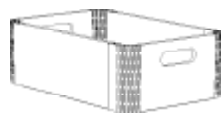
Product	Description	Dimensions	Code	CAD	USD
	Mochi undermount storage unit Black frame with horizontal shelf and vertical laptop divider. Specify PET wrap color, right or left handed door hinge and handle finish.	11" W x 18" H x 17" D	MCHU-####/#	\$475	\$400
	Mochi Storage Drawer, Ash Grey Top shelf slide-in storage drawer with pull cutout and perforated corners.	9.8"W x 15.3"D x 4.9" H	MCHD/AS	\$115	\$100

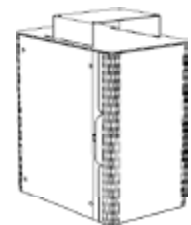

Right Handed (RH)
for attachment to right side of desk

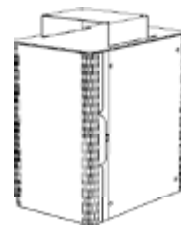

Left Handed (LH)
for attachment to left side of desk



Ex: RH Mochi shown

- Select PET Wrap Color Ripple Collection

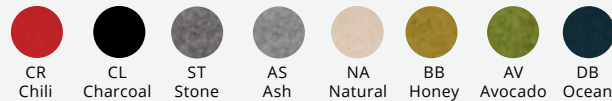

Select Right or Left Handed

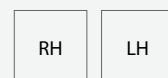

- Select Handle finish

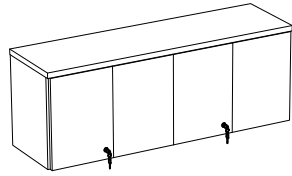

Overhead Storage

Product	Description	Dimensions	Code	CAD	USD
	Wall-mount hutch 4 locking doors	47.25" W x 16.9" H x 14" D	AX12WMH4D/W	\$1,240	\$870

Reception Counters

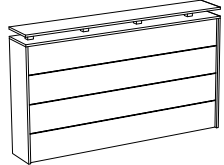
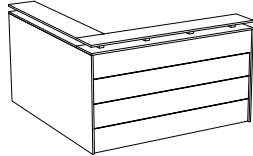
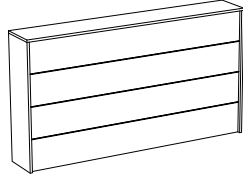
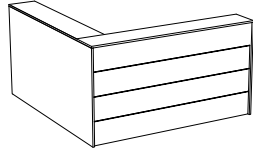
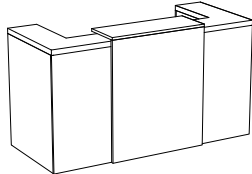
Product	Description	Dimensions	Code	CAD	USD
	Axis Reception Pop-top Fits over desk - AXSD1875/# - AX9W181875/#	72.5" wide x 42" high x 12" deep	AXRPD183/W	\$840	\$935
	Axis Reception Corner Pop-top Fits over workstation - AX9W181875/#	72.5" x 75" x 42" high x 12" deep Can be left or right handed	AXRPW18183/W	\$1,555	\$1,730
	Axis Reception Fits over desk - AXSD1875/# - AX9W181875/#	72.5" wide x 38.5" high x 12" deep	AXRD183/W	\$600	\$670
	Axis Reception Corner Fits over workstation - AX9W181875/#	72.5" x 75" x 38.5" high x 12" deep Can be left or right handed	AXRW18183/W	\$1,105	\$1,225
	Anvil Reception - White with White façade Fits over desk - AXSD1875/#	73"-96" wide x 37" deep x 42" high	ANRC/WW	\$1,970	\$2,190
	Anvil Reception - White with Silver façade Fits over desk - AXSD1875/#	73"-96" wide x 37" deep x 42" high	ANRC/WS	\$1,970	\$2,190
	Anvil Façade Upgrade Available in 3 woodgrain laminates shown below.	38.5" wide x 15" deep x 42" high	ANRFD/#	\$1,065	\$700

Please note:
Reception units require the desk to be ordered separately.

- Select Façade Upgrade Finish   





Privacy & Decor

Versi

- Linear screens.....104
- L-Shape screens.....105
- U-Shape screens.....106
- Half Desk screens.....107
- Brackets108
- Finishes109

Viro

- Planter Wall111

Versi privacy screens

Linear Screen

SKU: VSLN

Specify: VSLN 5723 /AS

screen style width/height finish color

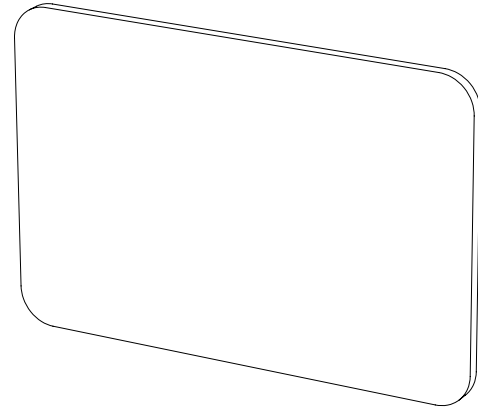

For use with Array power/data beam: Linear screens in 45", 57" and 69" widths in all available heights.

USD							
WIDTH	21"	27"	45"	51"	57"	63"	69"
HEIGHT							
11"	\$85	\$105	\$180	\$205	\$225	\$250	\$275
18"	\$120	\$140	\$215	\$250	\$280	\$300	\$345
23"	\$140	\$165	\$260	\$300	\$345	\$385	\$425
28"	\$140	\$205	\$320	\$365	\$420	\$465	\$520

CAD							
WIDTH	21"	27"	45"	51"	57"	63"	69"
HEIGHT							
11"	\$130	\$160	\$280	\$315	\$345	\$385	\$425
18"	\$185	\$215	\$330	\$385	\$430	\$465	\$530
23"	\$215	\$255	\$400	\$465	\$530	\$595	\$655
28"	\$260	\$315	\$495	\$565	\$650	\$715	\$800

- Select PET finish

Ripple Collection

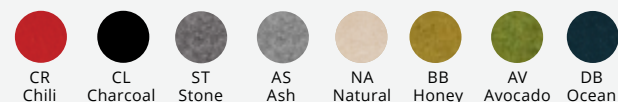

L-Shape Screen

SKU: VSLS

Specify: VSLS 632128 /AS

screen style width/return/height finish color

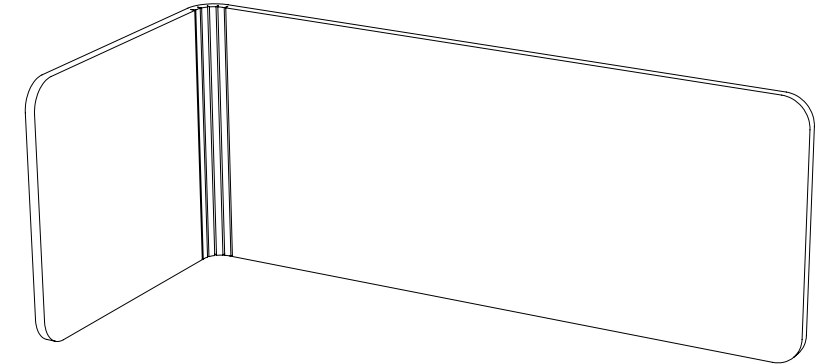

USD									
WIDTH	45"	45"	51"	51"	57"	57"	63"	63"	69"
RETURN	21"	27"	21"	27"	21"	27"	21"	27"	21"
SIZE	45" X 21" D	45 W X 27 D	51 W X 21 D	51 W X 27 D	57 W X 21 D	57 W X 27 D	63 W X 21 D	63 W X 27 D	69 W X 21 D
HEIGHT									
11"	\$260	\$285	\$285	\$310	\$310	\$335	\$335	\$355	\$355
18"	\$350	\$360	\$380	\$385	\$380	\$410	\$425	\$455	\$455
23"	\$420	\$460	\$455	\$495	\$485	\$520	\$545	\$585	\$585
28"	\$515	\$560	\$555	\$600	\$590	\$635	\$665	\$710	\$710

CAD									
WIDTH	45"	45"	51"	51"	57"	57"	63"	63"	69"
RETURN	21"	27"	21"	27"	21"	27"	21"	27"	21"
SIZE	45" X 21" D	45 W X 27 D	51 W X 21 D	51 W X 27 D	57 W X 21 D	57 W X 27 D	63 W X 21 D	63 W X 27 D	69 W X 21 D
HEIGHT									
11"	\$400	\$440	\$440	\$480	\$480	\$515	\$515	\$550	\$550
18"	\$540	\$555	\$585	\$595	\$585	\$635	\$655	\$700	\$700
23"	\$650	\$710	\$700	\$765	\$750	\$800	\$840	\$905	\$905
28"	\$795	\$865	\$855	\$925	\$910	\$980	\$1,025	\$1,095	\$1,095

Versi privacy screens

U-Shape Screen

SKU: VSU

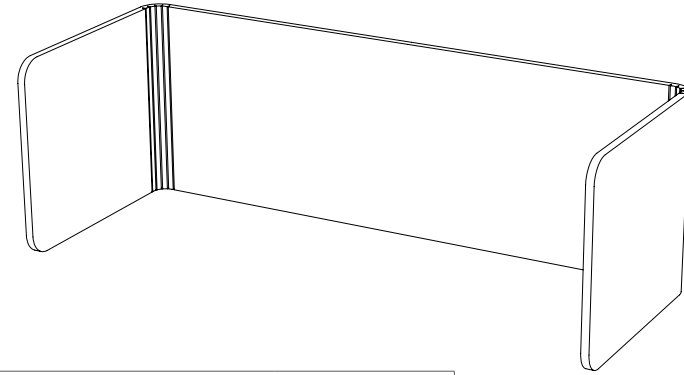

Specify: VSU 542118 /AS

screen style width/return/height finish color

USD					
WIDTH	47"	54"	59"	66"	71"
RETURN	23"	21"	18"	15"	12"
SIZE	47 W X 23 D	54 W X 21 D	59 W X 18 D	66 W X 15 D	71 W X 12 D
HEIGHT					
11"	\$370	\$375	\$375	\$375	\$375
18"	\$460	\$510	\$640	\$575	\$620
23"	\$590	\$645	\$780	\$730	\$780
28"	\$695	\$780	\$995	\$915	\$1,000

CAD					
WIDTH	47"	54"	59"	66"	71"
RETURN	23"	21"	18"	15"	12"
SIZE	47 W X 23 D	54 W X 21 D	59 W X 18 D	66 W X 15 D	71 W X 12 D
HEIGHT					
11"	\$570	\$580	\$580	\$580	\$580
18"	\$710	\$785	\$985	\$885	\$955
23"	\$910	\$995	\$1,205	\$1,125	\$1,205
28"	\$1,070	\$1,200	\$1,550	\$1,400	\$1,540

- Select PET finish

Ripple Collection

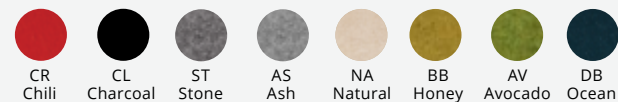

Half Desk

SKU: VSH

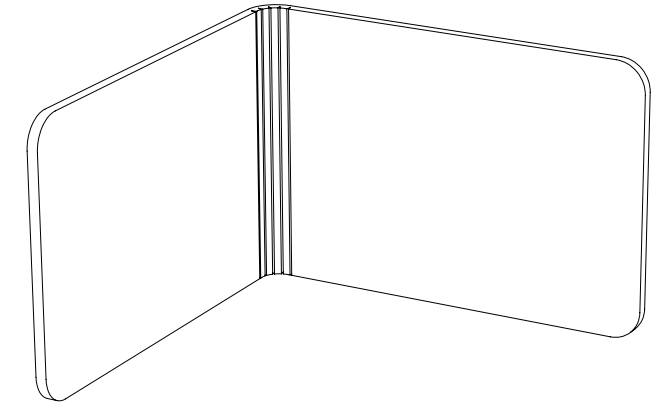

Specify: VSH 362123/AS

screen style width/return/height finish color

USD										
WIDTH	23"	23"	27"	27"	29"	29"	33"	33"	36"	36"
RETURN	21"	27"	21"	27"	21"	27"	21"	27"	21"	27"
SIZE	23 W X 21 D	23 W X 27 D	27 W X 21 D	27 W X 27 D	29 W X 21 D	29 W X 27 D	33 W X 21 D	33 W X 27 D	36 W X 21 D	36 W X 27 D
HEIGHT										
11"	\$175	\$200	\$190	\$215	\$200	\$220	\$215	\$240	\$225	\$250
18"	\$230	\$275	\$255	\$285	\$290	\$335	\$310	\$345	\$335	\$380
23"	\$295	\$335	\$325	\$365	\$370	\$410	\$395	\$440	\$425	\$470
28"	\$360	\$410	\$395	\$445	\$450	\$500	\$485	\$540	\$520	\$575

CAD										
WIDTH	23"	23"	27"	27"	29"	29"	33"	33"	36"	36"
RETURN	21"	27"	21"	27"	21"	27"	21"	27"	21"	27"
SIZE	23 W X 21 D	23 W X 27 D	27 W X 21 D	27 W X 27 D	29 W X 21 D	29 W X 27 D	33 W X 21 D	33 W X 27 D	36 W X 21 D	36 W X 27 D
HEIGHT										
11"	\$270	\$310	\$295	\$330	\$310	\$340	\$330	\$370	\$345	\$385
18"	\$355	\$425	\$395	\$440	\$445	\$515	\$480	\$530	\$515	\$585
23"	\$455	\$515	\$500	\$515	\$570	\$635	\$610	\$680	\$655	\$725
28"	\$555	\$635	\$610	\$685	\$695	\$770	\$750	\$835	\$800	\$885

Versi brackets

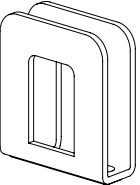
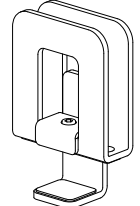
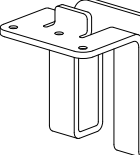
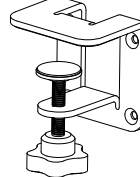
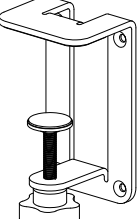
Product	Description	Dimensions	Code	CAD	USD
	Surface Mount Versi screen clip, Set of 2 Specify White, Silver or Black	See Versi spec sheet	SBSUR/#	\$40	\$25
	Surface Mount with Clamp Versi screen clip, Set of 2 Specify White, Silver or Black	See Versi spec sheet	SBSURC/#	\$115	\$75
	Slip Mount Versi screen clip, Set of 2 Specify White, Silver or Black	See Versi spec sheet	SBSLIP/#	\$40	\$25
	Clamp Mount Versi screen clip, Set of 2 Specify White, Silver or Black	See Versi spec sheet	SBCM/#	\$40	\$25
	Clamp Mount with extra depth Versi screen clip, Set of 2 Specify White or Silver	See Versi spec sheet	SBCME/#	\$40	\$25

- Select Bracket finish

Powdercoat W S B

Versi Screen + Bracket System

Screen PET Finishes

Ripple Collection



Bracket Finishes



Clamp Mount with Extra Depth not available in Black

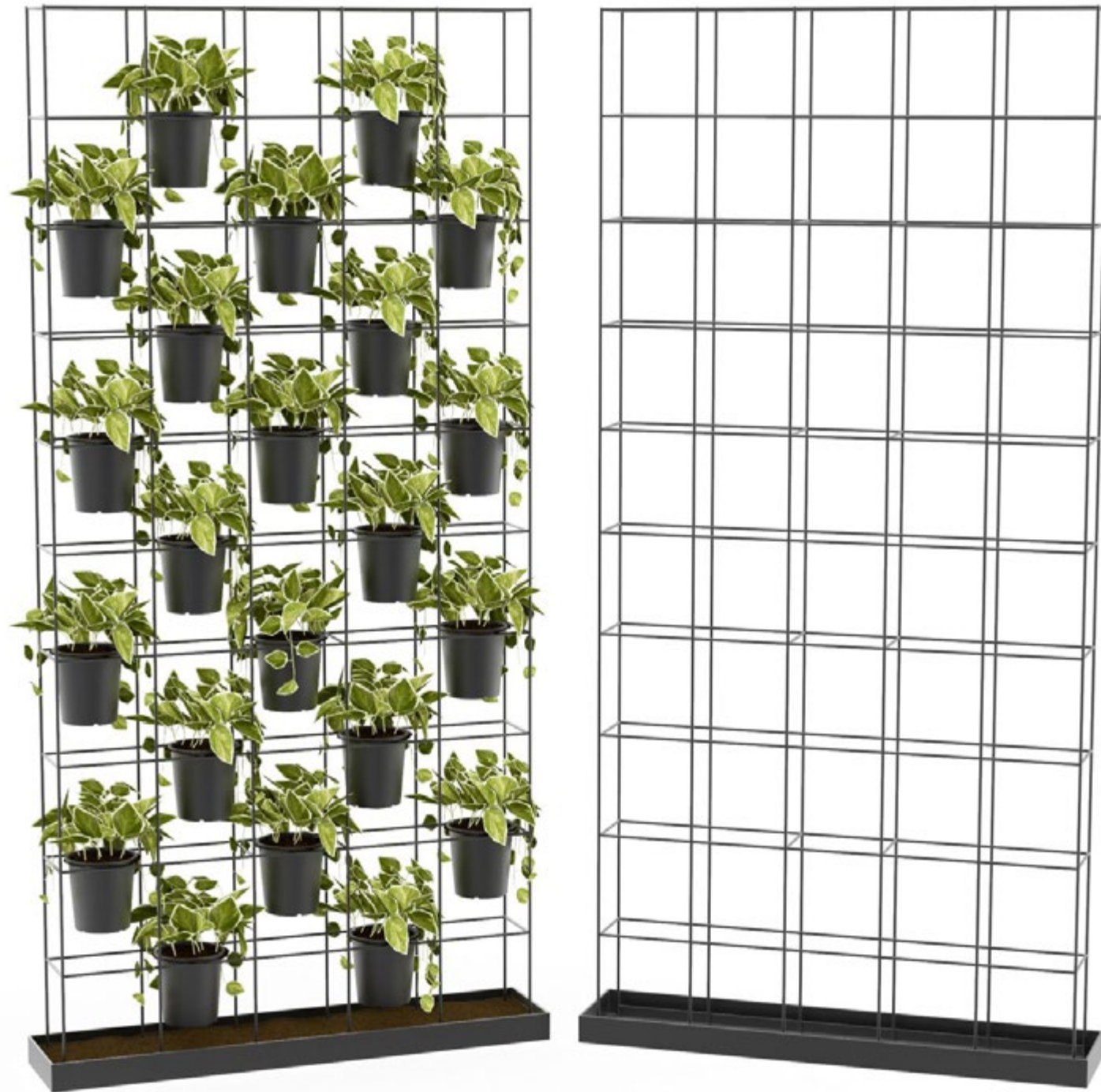

Viro Planter Wall

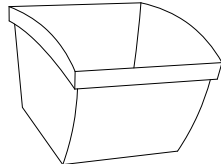
Product	Description	Dimensions	Code	CAD	USD
	Viro Wall Frame only	78" x 40" x 8"	PLANTER/B	\$2,380	\$2,300
	Pots		PLANTERPOT/B	\$70	\$45



Accessories & Components



- Orbit mobile divider..... 115
- Cable Management..... 116
- Monitor Arms..... 117

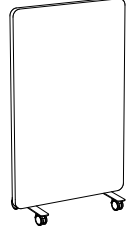
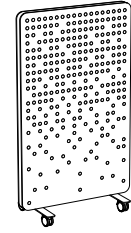

Orbit Divider

Product	Description	Dimensions	Code	CAD	USD
	Mobile Divider Whiteboard Locking casters	60" x 36"	ODM6036/WB	\$1,510	\$1,065
	Mobile Divider Pixel design Locking casters	60" x 36"	ODMPXL6036/ GYW	\$2,435	\$1,720

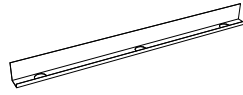
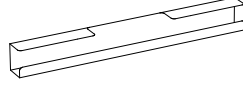
Cable Management

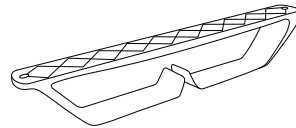
Product	Description	Dimensions	Code	CAD		USD	
				LPL	HPL	LPL	HPL
	Single-sided cable tray Power/data segregation Side fixing to Axis/Anvil horizontal support rail	42" Length	AXCTS11/#	\$125		\$120	
		60" Length	AXCTS14/#	\$165		\$160	
		72" Length	AXCTS17/#	\$195		\$190	
	Single-sided cable tray Power/data segregation Top Lip Fixing	42" Length	AXCTT11/#	\$125		\$120	
		60" Length	AXCTT14/#	\$165		\$160	
		72" Length	AXCTT17/#	\$195		\$190	
	Cable Cobra Black or White Power/data segregation	42" Length	CABCOBRA/#	\$95		\$95	
	Cable Clutch White Power/data segregation	Set of 5	CABCLUTCH_W	\$45		\$45	
	Cable Management Sleeve	Cable Management Sleeve, black/white neoprene, 1500 L	AGECBLSLV-1500	\$55		\$55	

- Select finish @ - Select finish

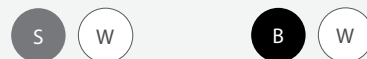

Cable Tray Covers

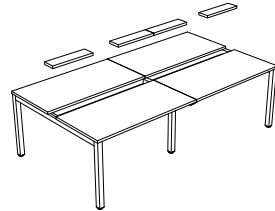
Product	Description	Dimensions	Code	CAD		USD	
				LPL	HPL	LPL	HPL
	Cable tray covers Includes hardware	Fits 48" Desk with Twin Power	AXT450125/#	\$200	\$255	\$195	\$230
		Fits 60" Desk with Twin Power	AXT600125/#	\$210	\$275	\$200	\$245
		Fits 72" Desk with Twin Power	AXT750125/#	\$220	\$290	\$210	\$260
		Fits 48" Desk with Quad Power	AXT407125/#	\$200	\$255	\$195	\$230
		Fits 60" Desk with Quad Power	AXT557125/#	\$210	\$265	\$200	\$240
		Fits 72" Desk with Quad Power	AXT707125/#	\$220	\$290	\$210	\$260

*Pricing is shown per pair.

Monitor Arms

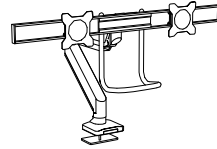
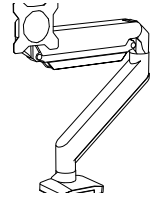
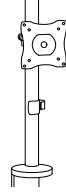
Product	Description	Dimensions	Code	CAD	USD
	Fulcrum Dual Gas spring arms Grab Handle Black	Accommodates 17" - 32" screen	FCDMA/B	\$510	\$500
	Fulcrum Single Gas spring arms Desk mount Black	Accommodates 17" - 49" screen	FCSMA/B	\$330	\$320
	Single monitor arm Desk mount Black	Accommodates 13" - 27" screen	FWMA1/B	\$240	\$235

- Select Worksurface Finish



General Inquiries

info@workspace48.com

Orders

orders@workspace48.com

Products, Pricing & Resources

www.workspace48.com



Stay Connected

in linkedin.com/company/workspace48

 instagram.com/workspace48

 youtube.com/@workspace48

WORKSPACE 

www.Workspace48.com

Showrooms by appointment only

79 Wingold Avenue

Toronto, ON M6B 1P8

Tel. +1 416-441-9898

200 Universal Road #22

Woodstock ON N4S 7W3

Tel. +1 519-533-1839

