

USA PRICEBOOK | 2024



WORKSPACE 
Office Furniture in 48 Hours!

Updated July, 2024

THE FUTURE OF OFFICE FURNITURE IS HERE.

Workspace48 has some of the best and brightest minds in the office furniture industry Galaxy! We understand the changing office landscape and have an out of this world catalogue of product knowledge to provide the best solutions for any office fit-out project.

It is our mission is to change & revolutionise the office furniture world around one fundamental concept... Everything in this catalogue and in-stock will ship within 48 hours!

Contents

| | |
|-------------------------------|-----|
| Seating | 5 |
| Tables | 17 |
| Desking | 41 |
| Receptions & Storage | 91 |
| Mobile Dividers..... | 99 |
| Accessories & Components..... | 103 |
| Product Warranty | 108 |
| Freight | 110 |
| Terms & Conditions..... | 111 |









Seating

| | |
|------------------------------|----|
| Essence & Compass Task | 6 |
| Balance Executive | 8 |
| Balance Seating | 9 |
| Mode | 10 |
| Adapta | 11 |
| Luna | 12 |
| Game | 13 |
| Link | 14 |
| Politan | 15 |
| Otto | 15 |

Essence Task

| Product | Description | Code | USD |
|---|---|---------|-----|
|  | Essence Black frame Nova fabric seat Adjustable arms | ESS/BCB | 617 |
|  | Essence White frame Nova Grey fabric seat Adjustable arms | ESS/GGW | 675 |

Compass Task







| Product | Description | Code | USD |
|---|--|----------|-----|
|  | Compass Black frame Nova fabric seat Adjustable arms Adjustable lumbar | COML/BCB | 833 |
|  | Compass White frame Nova Grey fabric seat Adjustable arms Adjustable lumbar | COML/GGW | 883 |

Please note:

All Essence and Compass seating come standard with hardfloor casters.

THIS PAGE IS INTENTIONALLY
LEFT BLANK

Balance Executive







| Product | Description | Code | USD |
|---|---|-------------|------|
|  | Black faux leather seat Polished alloy base Adjustable arms | BALM/PU | 1234 |
|  | White faux leather seat Polished alloy base Adjustable arms | BALM/WPU | 1234 |
|  | Black faux leather seat Polished alloy base Adjustable arms Lumbar | BALML/PU | 1318 |
|  | Black faux leather seat Polished alloy base Adjustable arms Headrest | BALH/PU | 1563 |
|  | Upgrade Hardfloor caster | SOFTCAST | 29 |
|  | Upgrade Chrome footring Bar height | BH_UP | 276 |
|  | Upgrade Breathe fabric seat cover | BALMCOV/BR# | 62 |

- Select fabric - Seat covers

Breathe



Balance Seating





| Product | Description | Code | USD |
|---|--|-----------|-----|
|  | Visitor Black frame Black mesh backrest Black fabric seat Fixed arms | BALV/BF | 584 |
|  | Task Black frame Black mesh backrest Black fabric seat Adjustable arms Adjustable height | BALNTA/BF | 713 |
|  | Training Black frame Black mesh backrest Black fabric seat Fixed arms | BALVA/BF | 661 |
|  | Training Black frame Black mesh backrest Black fabric seat | BALVNA/BF | 661 |
|  | Upgrade - Balance Task/Training Hardfloor caster | SOFTCAST | 29 |
|  | Upgrade - Balance Training Tablet arm kit | ADATAB | 134 |

Please note:

All seating on this page have seat covers which are not removable.

All seating products require partial assembly, except the Link chair and Otto stool.

Mode





| Product | Description | Code | USD |
|---|---|-----------|-----|
|  | Highback Black faux leather seat | MODH/PU | 998 |
| | Highback White faux leather seat | MODH/WPU | |
|  | Midback Black faux leather seat | MODM/PU | 959 |
| | Midback White faux leather seat | MODM/WPU | |
|  | Guest Black faux leather seat | MODV/PU | 794 |
| | Guest White faux leather seat | MODV/WPU | |
|  | Boardroom Black faux leather seat | MODMB/PU | 959 |
| | Boardroom White faux leather seat | MODMB/WPU | |
|  | Upgrade Hardfloor caster | SOFTCAST | 29 |

Please note:

All Mode seating with arm rests includes covers.

All seating products require partial assembly, except the Link chair and Otto stool.







Adapta

| Product | Description | Code | USD |
|--|--|-----------|-----|
|  | Black backrest Black fabric seat Polished alloy base Adjustable arms | ADASBA/BF | 518 |
|  | White backrest Black fabric seat Polished alloy base Adjustable arms | ADASWA/BF | 518 |
|  | Upgrade Hardfloor caster | SOFTCAST | 29 |
|  | Upgrade Tablet arm kit | ADATAB | 134 |
| | Upgrade Armless change kit <i>Required for Adapta chair with no arms</i> | ADAWOARM | 22 |

Please note:

All seating products require partial assembly, except the Link chair and Otto stool.

Luna

| Product | Description | Code | USD |
|---|---|--------------|-----|
|  | Chair Caster base Black shell Upholstered cushion | LUNAB_CAS/## | 535 |
|  | Chair Caster base White shell Upholstered cushion | LUNAW_CAS/## | 535 |
|  | Chair Oak base Black shell Upholstered cushion | LUNAB_OAK/## | 557 |
|  | Chair Oak base White shell Upholstered cushion | LUNAW_OAK/## | 557 |
|  | Barstool Oak base Black shell Upholstered cushion | LUNAB_BAR/## | 620 |
|  | Barstool Oak base White shell Upholstered cushion | LUNAW_BAR/## | 620 |







Please note:

All seating products require partial assembly, except the Link chair and Otto stool.

- Select fabric - upholstered cushion

Motion Felt **AS** **ST** **CL** **DB** **IC** **EM** **BB** **AV** **SO** **CR** Eurotex PU **B** **W**

Game

| Product | Description | Code | USD |
|---|--|---------------|-----|
|  | Barstool Chrome frame Charcoal shell | GMBSRCRSCN | 370 |
|  | Barstool Chrome frame Charcoal shell Upholstered seat | GMBSRCRSCS/B# | 402 |
|  | Barstool Chrome frame Charcoal shell Upholstered seat + backrest | GMBSRCRSCF/B# | 426 |
|  | Chair 4 Leg Chrome Charcoal shell | GM4LCRSCN | 261 |
|  | Chair 4 Leg Chrome Charcoal shell Upholstered seat | GM4LCRSCS/B# | 294 |
|  | Chair 4 Leg Chrome Charcoal shell Upholstered seat + backrest | GM4LCRSCF/B# | 318 |

Please note:



All seating products require partial assembly, except the Link chair and Otto stool.

- Select fabric - upholstered cushion(s)

Breathe





Link

| Product | Description | Code | USD |
|---|---|--------|-----|
|  | Silver frame Black shell | LKS/B | 164 |
|  | Silver frame White shell | LKS/W | 164 |
|  | Upgrade Trolley Holds up to 25 chairs Black powdercoat | LK/TLY | 488 |

Please note:

All seating products require partial assembly, except the Link chair and Otto stool.

Politan

| Product | Description | Code | USD |
|---|---------------------------------------|----------|------|
|  | 1 Seater Black faux leather | POL1/BPU | 967 |
|  | 2 Seater Black faux leather | POL2/BPU | 1062 |

Otto

| Product | Description | Code | USD |
|---|------------------------------------|-----------|-----|
|  | Ottoman Includes casters | MOSTOOL_# | 840 |

Please note:

All seating products require partial assembly, except the Link chair and Otto stool.

- Select fabric for Ottoman cover

Motion Felt AS ST CL DB IC EM BB AV SO CR





Tables

| | |
|----------------------------|----|
| Modulus Overview | 18 |
| Modulus Flip..... | 22 |
| Modulus Fixed Tables | 23 |
| Modulus Collar Leg..... | 24 |
| Modulus Accessories..... | 25 |
| Modulus Frame Only | 26 |
| Axis Tables Overview | 32 |
| Axis Tables | 34 |
| Axis Bar Leaners | 36 |
| Uni Flip Overview..... | 38 |
| Uni Flip | 39 |

Modulus Flip

Frames:

Black Matte or Arctic White Powdercoat finish to the posts, rails & pull bars
Polished alloy feet

Worksurfaces:

1" M2 Grade substrate
Studio White Melamine finish
Matching 2mm PVC edge

Features:

Swiveling lockable casters
Strong flip mechanism has safety stay upright locks

Flip - Small

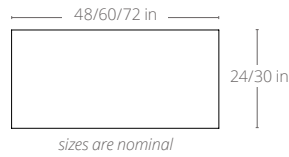
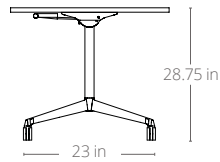

Flip - Large

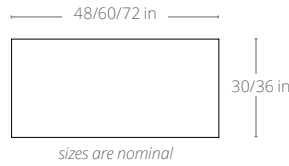
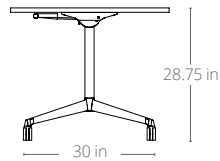

Additional Frame Details

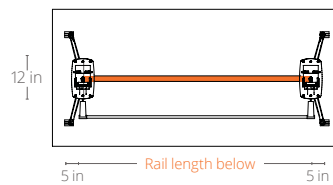
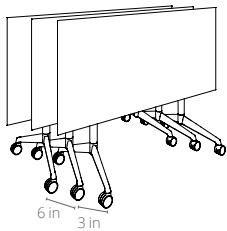

| Rail Length Below | |
|-------------------|---------|
| FWFLRAIL50 | = 20 in |
| FWFLRAIL80 | = 32 in |
| FWFLRAIL110 | = 44 in |
| FWFLRAIL140 | = 56 in |

Modulus Fixed Leg

Frames:

Black Matte Powdercoat finish to all posts & rails
 Polished alloy feet and worktop supports

Worksurfaces:

1" M2 Grade substrate
 Studio White Melamine finish
 Matching 2mm PVC edge

Features:

Leveling glides

Fixed Leg - Small

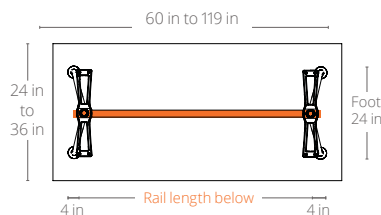
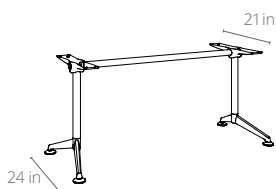

| Rail Length Below | |
|-------------------|---------|
| FWTOPRAIL1000 | = 40 in |
| FWTOPRAIL1100 | = 50 in |
| FWTOPRAIL1300 | = 58 in |
| FWTOPRAIL1600 | = 68 in |
| FWTOPRAIL1900 | = 81 in |
| FWTOPRAIL2200 | = 93 in |

Fixed Leg - Wide

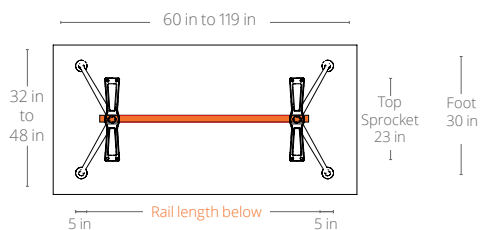
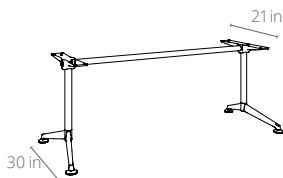

| Rail Length Below | |
|-------------------|---------|
| FWTOPRAIL1000 | = 40 in |
| FWTOPRAIL1100 | = 50 in |
| FWTOPRAIL1300 | = 58 in |
| FWTOPRAIL1600 | = 68 in |
| FWTOPRAIL1900 | = 81 in |
| FWTOPRAIL2200 | = 93 in |

Modulus Collar Leg

Frames:

Black Matte Powdercoat finish to all posts & rails
Polished alloy feet and worktop supports

Worksurfaces:

1" M2 Grade substrate
Stock Classic White LPL, 3 HPL woodgrains
Matching 2mm PVC edge

Features:

Leveling glides

Collar Leg - Twin Post

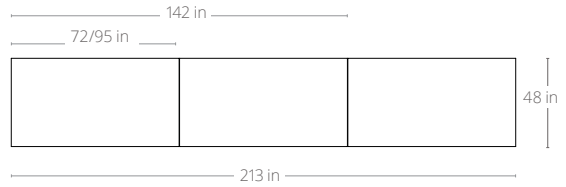
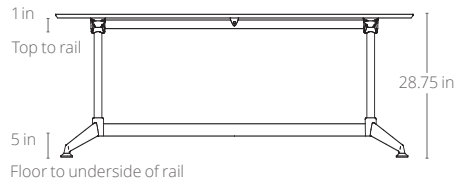

Additional Frame Details

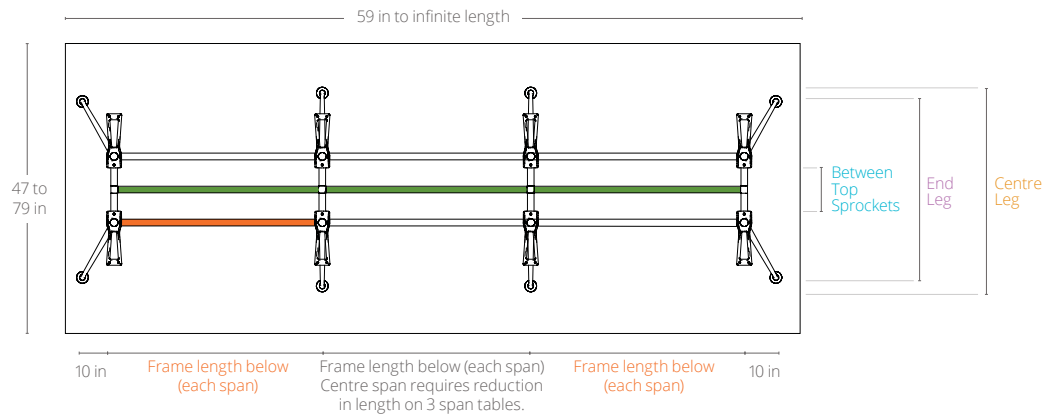

10 in Frame length below (each span) Frame length below (each span) Frame length below (each span) 10 in
Centre span requires reduction in length on 3 span tables.

| Top rail length (each span) Two beams per span | Lower beam length (each span) One beam per span |
|---|--|
| FWTOPRAIL1100 = 49 in | FWBOTRAIL1100 = 43 in |
| FWTOPRAIL1300 = 57 in | FWBOTRAIL1300 = 51 in |
| FWTOPRAIL1600 = 69 in | FWBOTRAIL1600 = 63 in |
| FWTOPRAIL1900 = 81 in | FWBOTRAIL1900 = 75 in |
| FWTOPRAIL2200 = 93 in | FWBOTRAIL2200 = 87 in |



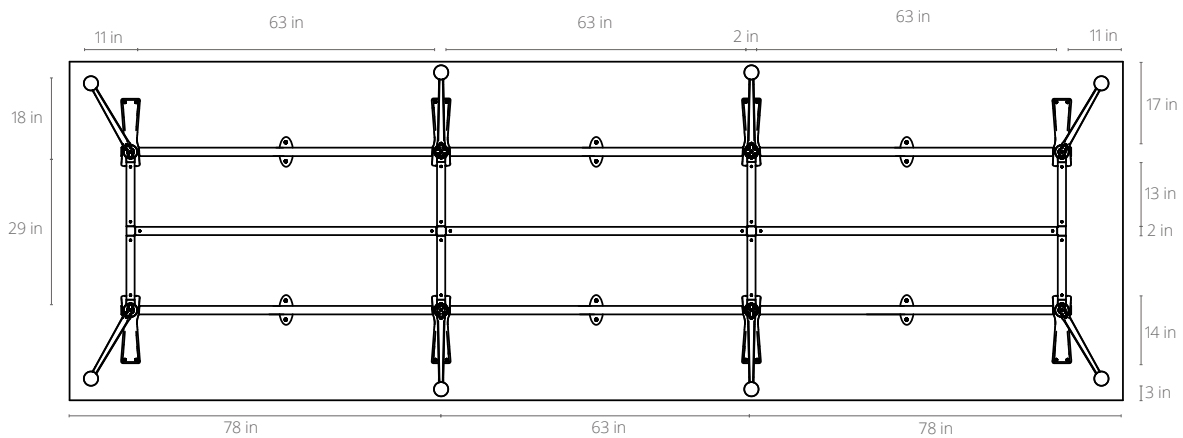
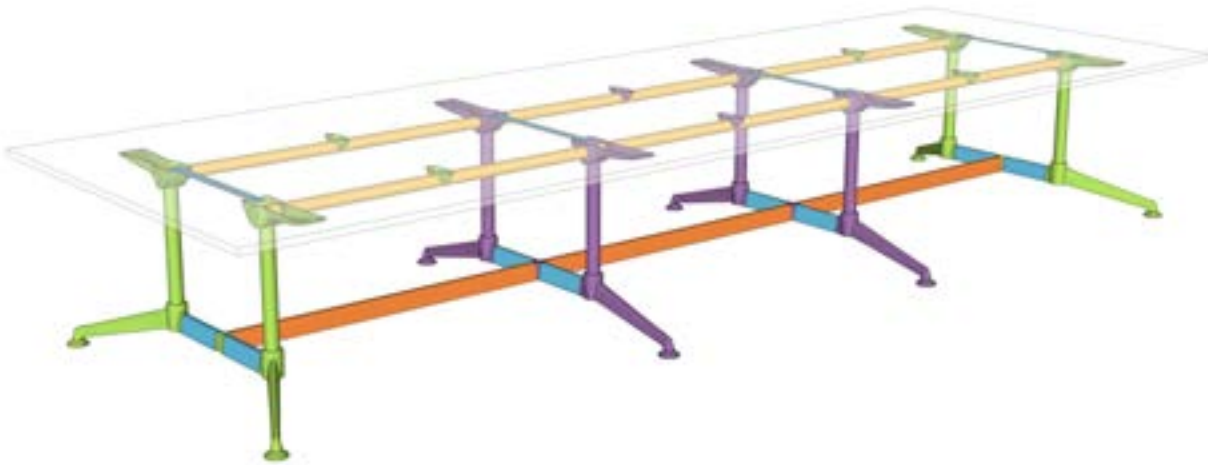

| Leg Width Kit | End Leg | Centre Leg | Between Top Sprockets Alloy |
|------------------|------------|---------------|--------------------------------|
| FW1200 | 48 in | 50 in | 7 in |
| FW1400 | 55 in | 54 in | 12 in |
| FW1600 | 57 in | 62 in | 19 in |
| FW1800 | 66 in | 70 in | 27 in |

Component Breakdown

| Stockcode/Packs | Description | Quantity |
|-----------------|------------------------------------|----------|
| FWMOD-04END_B | Twin Post End Leg Pair with Collar | 1 |
| FW1800SET_B | Width Connector Beam | 2 |
| FWMOD-04MID_B | Twin Post Centre Leg with Collar | 2 |
| FWTOPRAIL1600_B | Upper Rails | 6 |
| FWBOTRAIL1600_B | Lower Beam Set | 3 |

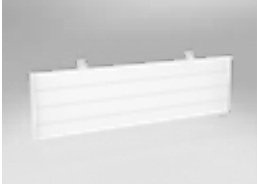

Modulus Flip

| Product | Description | Worktop | Code | LPL | HPL |
|---|--|-----------------------------------|---------------|------|------|
|  | Flip table Black posts & rails Polished aluminum feet 2x locking casters | 48" x 24" | MFLIP126B/# | 845 | 913 |
| | | 60" x 24" | MFLIP156B/# | 901 | 990 |
| | | 72" x 24" | MFLIP186B/# | 962 | 1044 |
| | | 48" x 30" | MFLIP1275B/# | 881 | 972 |
| | | 60" x 30" | MFLIP1575B/# | 948 | 1056 |
| | | 72" x 30" | MFLIP1875B/# | 1017 | 1151 |
| | | 72" x 36" | MFLIP189B/# | 1063 | 1232 |
|  | Flip table White posts & rails Polished aluminum feet 2x locking casters | 48" x 24" | MFLIP126W/# | 845 | 913 |
| | | 60" x 24" | MFLIP156W/# | 901 | 990 |
| | | 72" x 24" | MFLIP186W/# | 962 | 1044 |
| | | 48" x 30" | MFLIP1275W/# | 881 | 972 |
| | | 60" x 30" | MFLIP1575W/# | 948 | 1056 |
| | | 72" x 30" | MFLIP1875W/# | 1017 | 1151 |
| | | 72" x 36" | MFLIP189W/# | 1063 | 1232 |
|  | Accessories Flip table link | | GANGMECH/B | 63 | |
|  | Accessories Modesty kit Powdercoat | Suits top size 48" 31"w x 14"h | MFMOD125/@ | 230 | |
| | | Suits top size 60" 43"w x 14"h | MFMOD145/@ | 316 | |
| | | Suits top size 72" 55"w x 14"h | MFMOD165/@ | 402 | |
|  | Upgrade Cable tray 36" Length Undermount <i>Note: Fits 60"/72"W and 30"D tables only</i> | | ELECTRAY900/W | 193 | |

@ - Select modesty finish

Powdercoat





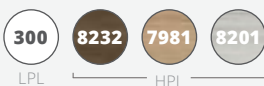

- Select worksurface finish

Laminate





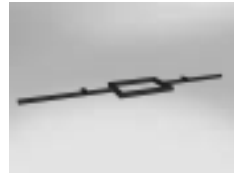

Modulus Tables

Fixed leg

| Product | Description | Worktop | Code | LPL | HPL |
|---|---|----------------------------|-------------------|------|------|
|  | Side table Single post | 24" x 24" x 18" high | MT66/# | 406 | 423 |
|  | Meeting table Single Post Fixed leg Round | 36" diameter x 28.75" high | MT090R/# | 581 | 642 |
| | | 42" diameter x 28.75" high | MT105R/# | 636 | 745 |
|  | Meeting table Single Post Fixed leg Square | 39" x 39" x 28.75" high | MT1010/# | 621 | 779 |
|  | Meeting table Four Post Fixed leg Round | 60" diameter x 28.75" high | MT150R/# | 1587 | 1757 |
|  | Meeting table 1 Piece Top Fixed leg Rectangle | 72" x 24" x 28.75" high | MT186/# | 904 | 986 |
| | | 72" x 30" x 28.75" high | MT1875/# | 935 | 1069 |
| | | 72" x 36" x 28.75" high | MT189/# | 959 | 1128 |
| | | 60" x 24" x 28.75" high | MT156/# | 826 | 915 |
| | | 60" x 30" x 28.75" high | MT1575/# | 881 | 989 |
| | | 48" x 24" x 28.75" high | MT126/# | 808 | 876 |
| | | 48" x 30" x 28.75" high | MT1275/# | 823 | 914 |
|  | Upgrade 92.5" post for single post tables to accommodate power module Black matte Suits power boxes up to 20" x 12" <i>Note: Can be cut down to suit shorter tops</i> | | FWTOPRAILPBOX2200 | 371 | |



- Select worksurface finish

Laminate

| | | | |
|---|---|---|---|
|  |  |  |  |
| LPL | HPL | | |



Modulus Tables

Collar leg

| Product | Description | Worktop | Code | LPL | HPL |
|---|-------------------------------------|--------------------------|----------|------|------|
|  | Meeting table 1 piece top | 72" x 48" x 28.75" high | MT1812/# | 1945 | 2145 |
| | Twin post | 95" x 48" x 28.75" high | MT2412/# | 2081 | 2396 |
|  | Meeting table 2 piece top | 120" x 48" x 28.75" high | MT3012/# | 3073 | 3451 |
| | Twin post | 142" x 48" x 28.75" high | MT3612/# | 3276 | 3676 |
|  | Meeting table 3 piece top | 213" x 48" x 28.75" high | MT5412/# | 4696 | 5296 |
| | Twin post | | | | |

Modulus Tables with Cutouts

Collar leg

| Product | Description | Worktop | Code | LPL | HPL |
|---|---|--------------------------|-------------|------|------|
|  | Meeting table 1-piece top | 72" x 48" x 28.75" high | MT1812/#-1C | 1997 | 2197 |
| | Twin post 1 cutout for Interact power module (8.375" x 4.75") | 95" x 48" x 28.75" high | MT2412/#-1C | 2122 | 2437 |
|  | Meeting table 2-piece top | 120" x 48" x 28.75" high | MT3012/#-2C | 3117 | 3495 |
| | Twin post 2 cutouts for Interact power module (8.375" x 4.75") | 142" x 48" x 28.75" high | MT3612/#-2C | 3379 | 3779 |
|  | Meeting table 3-piece top | 213" x 48" x 28.75" high | MT5412/#-1C | 4747 | 5347 |
| | Twin post Includes 1-3 cutouts for Interact power module (8.375" x 4.75") | 213" x 48" x 28.75" high | MT5412/#-2C | 4800 | 5400 |
| | | 213" x 48" x 28.75" high | MT5412/#-3C | 4851 | 5451 |

-1C, -2C, -3C in part number code, indicates how many sections require cutouts.

- Select worksurface finish

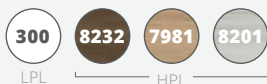

Laminate



LPL





HPL

Modulus Accessories

| Product | Description | Code | USD |
|--|---|---------------|-----|
|  | <p>Power module White Includes 2 power outlets, 3 Cat6 RJ45 data outlets 108" cord length Custom telecom outlets available</p> | ACT-21/GW-108 | 855 |
|  | <p>Cable cobra Black Power/data segregation</p> | CABCOBRA/B | 88 |
|  | <p>Cable clutch - set of 5 White Below desk cable management</p> | CABCLUTCH_W | 43 |







Modulus Flip

Frame only

| Product | Description | Suits Worktop Length | Code | USD |
|---|--|----------------------|-------------|-----|
|  | Flip table frame Black - standard Suits worksurface depth 24 - 36" | 36" - 51" | MFLIP050/B | 663 |
| | | 48" - 63" | MFLIP080/B | 682 |
| | | 60" - 75" | MFLIP110/B | 699 |
| | | 72" - 84" | MFLIP140/B | 724 |
|  | Flip table frame White - standard - Suits worksurface depth 24 - 36" | 36" - 51" | MFLIP050/W | 663 |
| | | 48" - 63" | MFLIP080/W | 682 |
| | | 60" - 75" | MFLIP110/W | 699 |
| | | 72" - 84" | MFLIP140/W | 724 |
|  | Flip table frame Black - large Suits worksurface depth 30" - 41" | 36" - 51" | MFLIPL050/B | 801 |
| | | 48" - 63" | MFLIPL080/B | 819 |
| | | 60" - 75" | MFLIPL110/B | 838 |
| | | 72" - 84" | MFLIPL140/B | 862 |
|  | Flip table frame White - large Suits worksurface depth 30" - 41" | 36" - 51" | MFLIPL050/W | 801 |
| | | 48" - 63" | MFLIPL080/W | 819 |
| | | 60" - 75" | MFLIPL110/W | 838 |
| | | 72" - 84" | MFLIPL140/W | 862 |

Modulus Tables



Frame only

| Product | Description | Suits Worktop Size | Code | USD |
|---|---|---------------------------------|------------------|------|
|  | Meeting table frame Frame height: 17" Polished aluminum feet | 16"-28" round 16"-24" square | CA-FWMOD11.16R/B | 317 |
|  | Meeting table frame Frame height: 27.75" Polished aluminum feet | 16"-28" round 16"-24" square | CA-FWMOD11.15R/B | 319 |
|  | Meeting table frame Frame height: 27.75" Polished aluminum feet | 32"-48" round 28"-39" square | CA-FWMOD11.1R/B | 409 |
|  | Meeting table frame Frame height: 27.75" Polished aluminum feet | 54"-72" round 48"-66" square | CA-FWMOD11.2R/B | 1195 |
|  | Upgrade Bar-height poles Suitable for: Single post pedestal base | Frame height 41" High | MODZA22-808 | 131* |
|  | Upgrade Bar-height poles Suitable for: 4 post pedestal base | Frame height 41" High | MODZA22-758 | 68* |

*Price is per pole





Modulus Tables

Fixed leg - frame only

| Product | Description | Suits Worktop Length | Code | USD |
|--|--|----------------------|-------------------|-----|
|  | Meeting table frame | 48"-54" | MT1206F/B | 624 |
| | Small fixed leg Suits worksurface depth of 24"-30" | 55"-75" | MT1406F/B | 626 |
| | | 63"-83" | MT1606F/B | 644 |
|  | Meeting table frame | 48"-54" | MT1208F/B | 630 |
| | Large fixed leg Suits worksurface depth of 30"-36" | 55"-75" | MT1408F/B | 646 |
| | | 63"-83" | MT1608F/B | 665 |
|  | Upgrade 92.5" Long post for single post tables to accommodate power module Black Suits powerboxes up to 20" x 12" Note: Can be cut down to suit shorter tops | | FWTOPRAILPBOX2200 | 371 |

Modulus Tables





Collar leg - frame only

| Product | Description | Suits Worktop Length | Code | USD |
|---|---|--------------------------|-------------|------|
|  | Meeting table frame Single span Suits work surface depth of 48"-54" | 67"-83" | MT1412CC/B | 1547 |
| | | 74"-95" | MT1612CC/B | 1548 |
| | | 99"-118" | MT1912CC/B | 1596 |
| | | 110"-130" | MT2512CC/B | 1695 |
|  | Meeting table frame Single span Suits work surface depth of 55"-62" | 67"-83" | MT1414CC/B | 1565 |
| | | 74"-95" | MT1614CC/B | 1566 |
| | | 99"-118" | MT1914CC/B | 1614 |
| | | 110"-130" | MT2514CC/B | 1713 |
|  | Meeting table frame Single span Suits work surface depth of 64"-69" | 67"-83" | MT1416CC/B | 1595 |
| | | 74"-95" | MT1616CC/B | 1595 |
| | | 99"-118" | MT1916CC/B | 1644 |
| | | 110"-130" | MT2516CC/B | 1743 |
|  | Meeting table frame Single span Suits work surface depth of 72"-79" | 67"-83" | MT1418CC/B | 1598 |
| | | 74"-95" | MT1618CC/B | 1628 |
| | | 99"-118" | MT1918CC/B | 1675 |
| | | 110"-130" | MT2518CC/B | 1773 |
|  | Upgrade Bar-height poles Twin pole/four pole Pedestal base | Frame height 41" High | MODZA22-758 | 68* |

*Price is per pole, order qty will depend on the size of the base.

Modulus Tables

Collar leg - frame only

| Product | Description | Suits Worktop Length | Code | USD |
|---|--|----------------------|-------------|------|
|  | Meeting table frame Double Span Suits worksurface depth of 48"-54" | 114"-130" | MT2612CC2/B | 2375 |
| | | 130"-146" | MT3012CC2/B | 2435 |
| | | 154"-169" | MT3612CC2/B | 2546 |
| | | 201"-217" | MT4812CC2/B | 2728 |
|  | Meeting table frame Double Span Suits worksurface depth of 55"-62" | 114"-130" | MT2614CC2/B | 2403 |
| | | 130"-146" | MT3014CC2/B | 2462 |
| | | 154"-169" | MT3614CC2/B | 2583 |
| | | 201"-217" | MT4814CC2/B | 2756 |
|  | Meeting table frame Double Span Suits worksurface depth of 64"-69" | 114"-130" | MT2616CC2/B | 2445 |
| | | 130"-146" | MT3016CC2/B | 2504 |
| | | 154"-169" | MT3616CC2/B | 2625 |
| | | 201"-217" | MT4816CC2/B | 2756 |
|  | Meeting table frame Double Span Suits worksurface depth of 72"-79" | 114"-130" | MT2618CC2/B | 2493 |
| | | 130"-146" | MT3018CC2/B | 2551 |
| | | 154"-169" | MT3618CC2/B | 2673 |
| | | 201"-217" | MT4818CC2/B | 2847 |
|  | Upgrade Bar-height poles Twin pole/Four pole Pedestal base | 41" High | MODZA22-758 | 68* |

*Price is per pole, order qty will depend on the size of the base.

Modulus Tables

Collar leg - frame only

| Product | Description | Suits Worktop Length | Code | USD |
|---|---|----------------------|-------------|------|
|  | Meeting table frame Triple Span Suits worksurface depth of 48"-54" | 158"-177" | MT3712CC3/B | 3207 |
| | | 181"-201" | MT4312CC3/B | 3294 |
| | | 217"-232" | MT5212CC3/B | 3493 |
| | | 288"-303" | MT7012CC3/B | 4354 |
|  | Meeting table frame Triple Span Suits worksurface depth of 55"-62" | 158"-177" | MT3714CC3/B | 3243 |
| | | 181"-201" | MT4314CC3/B | 3378 |
| | | 217"-232" | MT5214CC3/B | 3471 |
| | | 288"-303" | MT7014CC3/B | 4389 |
|  | Meeting table frame Triple Span Suits worksurface depth of 64"-69" | 158"-177" | MT3716CC3/B | 3300 |
| | | 181"-201" | MT4316CC3/B | 3396 |
| | | 217"-232" | MT5216CC3/B | 3527 |
| | | 288"-303" | MT7016CC3/B | 4446 |
|  | Meeting table frame Triple Span Suits worksurface depth of 72"-79" | 158"-177" | MT3718CC3/B | 3412 |
| | | 181"-201" | MT4318CC3/B | 3449 |
| | | 217"-232" | MT5218CC3/B | 3471 |
| | | 288"-303" | MT7018CC3/B | 4511 |

Axis Tables

Frames:

Silver or Arctic White
Powdercoat finish to all
posts and rails

Worksurfaces:

1" M2 Grade substrate
Studio White Melamine finish
Matching 2mm PVC edge

Coffee Table

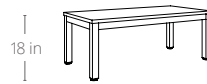
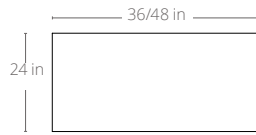
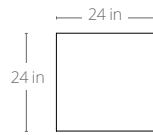

Meeting Table

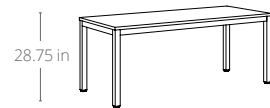
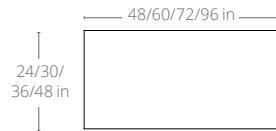
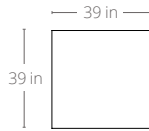
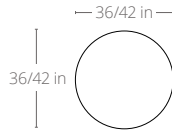

Axis Bar Leaner

Frames:

Black Matte or Arctic White
Powdercoat finish to all
posts and rails

Worksurfaces:

1" M2 Grade substrate
Studio White Melamine finish
Matching 2mm PVC edge

Bar Leaner

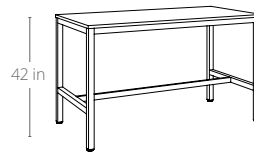
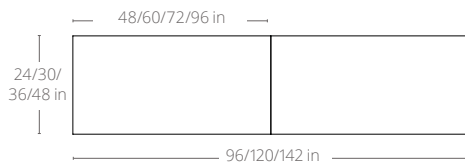

Axis Tables

| Product | Description | Worktop | Code | LPL | HPL |
|---|--|--------------|------------|------|------|
|  | Coffee table 18" height | 24" x 24" | AXCT66/## | 403 | 420 |
| | | 36" x 24" | AXCT96/## | 492 | 534 |
| | | 48" x 24" | AXCT126/## | 564 | 632 |
|  | Meeting table 28.75" height | 48" x 24" | AXT126/## | 639 | 707 |
| | | 60" x 24" | AXT156/## | 707 | 796 |
| | | 72" x 24" | AXT186/## | 772 | 854 |
| | | 48" x 30" | AXT1275/## | 690 | 781 |
| | | 60" x 30" | AXT1575/## | 780 | 888 |
| | | 72" x 30" | AXT1875/## | 841 | 975 |
| | | 72" x 36" | AXT189/## | 859 | 1028 |
| | | 60" x 48" | AXT1512/## | 1122 | 1131 |
| | | 72" x 48" | AXT1812/## | 1013 | 1213 |
| | | 96" x 48" | AXT2412/## | 1043 | 1358 |
|  | Meeting table round 28.75" height | 36" diameter | AXT090R/## | 498 | 559 |
| | | 42" diameter | AXT105R/## | 515 | 624 |
| | | 60" diameter | AXT150R/## | 758 | 928 |
|  | Meeting table square 28.75" height | 39" x 39" | AXT1010/## | 657 | 815 |

- Select finishes

Powdercoat





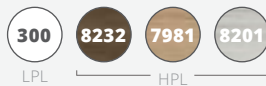

+ Laminate



Axis Tables

Frame only

| Product | Description | Suits Worktop | Code | USD |
|---|--|------------------------|--------------|-----|
|  | Coffee table 18" height | 24" x 24" | AXCT66/#_F | 344 |
| | | 36" x 24" | AXCT96/#_F | 376 |
| | | 48" x 24" | AXCT126/#_F | 399 |
|  | Meeting table 28.75" height | 48" x 24" | AXT126/#_F | 477 |
| | | 60" x 24" | AXT156/#_F | 508 |
| | | 72" x 24" | AXT186/#_F | 535 |
| | | 48" x 30" | AXT1275/#_F | 494 |
| | | 60" x 30" | AXT1575/#_F | 524 |
| | | 72" x 30" | AXT1875/#_F | 551 |
| | | 72" x 36" | AXT189/#_F | 566 |
| | | 60" x 48" | AXT1512/#_F | 766 |
| | | 72" x 48" | AXT-1812/#_F | 587 |
| | | 96" x 48" | AXT-2412/#_F | 626 |
| | | 96" x 48" (Inset legs) | AXT2412I/#_F | 626 |
|  | Meeting table round 28.75" height | 36" diameter | AXT-090R/#_F | 289 |
| | | 42" diameter | AXT-105R/#_F | 289 |
| | | 60" diameter | AXT-150R/#_F | 289 |
|  | Meeting table square 28.75" height | 39" x 39" | AXT-1010/#_F | 289 |



- Select frame finish

Powdercoat

S

W

Axis Bar Leaner

| Product | Description | Worktop | Code | LPL | HPL |
|---|-------------------------------------|------------|-------------|------|------|
|  | Bar leaner Single worktop | 48" x 24" | AXBL1260/## | 820 | 888 |
| | | 60" x 24" | AXBL1560/## | 872 | 961 |
| | | 72" x 24" | AXBL1860/## | 898 | 980 |
| | | 48" x 30" | AXBL1275/## | 962 | 1053 |
| | | 60" x 30" | AXBL1575/## | 966 | 1074 |
| | | 72" x 30" | AXBL1875/## | 1037 | 1171 |
| | | 72" x 36" | AXBL1890/## | 1075 | 1244 |
| | | 60" x 48" | AXBL1512/## | 1137 | 1326 |
| | | 72" x 48" | AXBL1812/## | 1237 | 1437 |
| | | 96" x 48" | AXBL2412/## | 1434 | 1749 |
|  | Bar leaner Double worktop | 96" x 24" | AXBL2460/## | 1506 | 1642 |
| | | 120" x 24" | AXBL3060/## | 1663 | 1841 |
| | | 142" x 24" | AXBL3660/## | 1799 | 1963 |
| | | 96" x 30" | AXBL2475/## | 1607 | 1789 |
| | | 120" x 30" | AXBL3075/## | 1788 | 2004 |
| | | 142" x 30" | AXBL3675/## | 1936 | 2204 |
| | | 142" x 36" | AXBL3690/## | 1992 | 2330 |
| | | 120" x 48" | AXBL3012/## | 2099 | 2477 |
| | | 142" x 48" | AXBL3612/## | 2299 | 2699 |

- Select finishes

Powdercoat



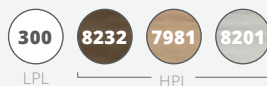

+

Laminate



Axis Bar Leaner

Frame only

| Product | Description | Suits Worktop | Code | USD |
|---|--|---------------|--------------|------|
|  | Bar leaner Frame only Single worktop` | 48" x 24" | AXBL1260/#_F | 659 |
| | | 60" x 24" | AXBL1560/#_F | 676 |
| | | 72" x 24" | AXBL1860/#_F | 698 |
| | | 48" x 30" | AXBL1275/#_F | 718 |
| | | 60" x 30" | AXBL1575/#_F | 730 |
| | | 72" x 30" | AXBL1875/#_F | 748 |
| | | 72" x 36" | AXBL1890/#_F | 785 |
| | | 60" x 48" | AXBL1512/#_F | 782 |
| | | 72" x 48" | AXBL1812/#_F | 818 |
| | | 96" x 48" | AXBL2412/#_F | 914 |
|  | Bar leaner Frame only Double worktop | 96" x 24" | AXBL2460/#_F | 1181 |
| | | 120" x 24" | AXBL3060/#_F | 1264 |
| | | 142" x 24" | AXBL3660/#_F | 1325 |
| | | 96" x 30" | AXBL2475/#_F | 1215 |
| | | 120" x 30" | AXBL3075/#_F | 1297 |
| | | 142" x 30" | AXBL3675/#_F | 1358 |
| | | 142" x 36" | AXBL3690/#_F | 1409 |
| | | 120" x 48" | AXBL3012/#_F | 1388 |
| | | 142" x 48" | AXBL3612/#_F | 1464 |

- Select frame finish

Powdercoat



Uni Flip

Frames:

Silver Powdercoat finish to all posts, rails & pull bars

Worksurfaces:

1" M2 Grade substrate
Studio White Melamine finish
Matching 2mm PVC edge

Features:

Swiveling lockable casters

Flip - Small

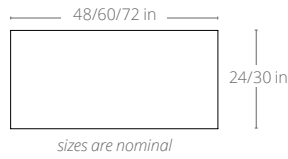
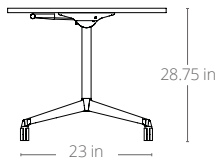

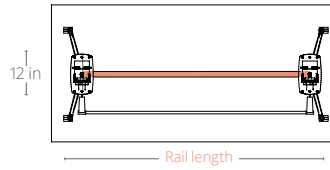
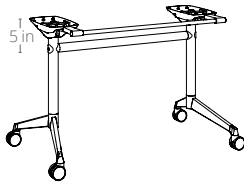
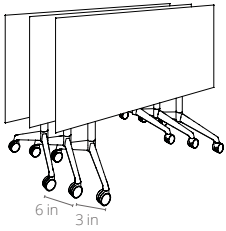

Additional Frame Details

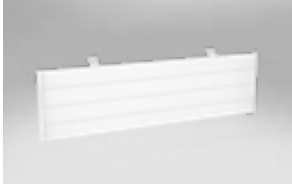

| Rail Length | |
|-------------|---------|
| FWFLRAIL50 | = 32 in |
| FWFLRAIL80 | = 42 in |
| FWFLRAIL110 | = 55 in |
| FWFLRAIL140 | = 67 in |

Uni Flip

| Product | Description | Worktop | Code | LPL | HPL |
|---|---|---------------------------------|----------------|-----|------|
|  | Flip table Silver frame 2 x locking casters | 48" x 24" | UNIFLIP1260S/# | 776 | 844 |
| | | 60" x 24" | UNIFLIP1560S/# | 837 | 926 |
| | | 72" x 24" | UNIFLIP1860S/# | 898 | 980 |
| | | 48" x 30" | UNIFLIP1275S/# | 812 | 903 |
| | | 60" x 30" | UNIFLIP1575S/# | 883 | 991 |
| | | 72" x 30" | UNIFLIP1875S/# | 950 | 1084 |
| | | 72" x 36" | UNIFLIP189S/# | 954 | 1123 |
|  | Accessories Modesty kit Powdercoat | Suits top size 48", 31"w x 14"h | MFMOD125/@ | 230 | |
| | | Suits top size 60", 43"w x 14"h | MFMOD145/@ | 316 | |
| | | Suits top size 72", 55"w x 14"h | MFMOD165/@ | 402 | |
| | Flip table link | Ganging mechanism | GANGMECH/B | 63 | |
|  | Upgrade Cable tray 36" Length Undermount | | ELECTRAY900/W | 193 | |

Uni Flip - Frame Only

| Product | Description | Suits Worktop Length | Code | USD |
|---|---|----------------------|--------------|-----|
|  | Flip Table Frame only Silver frame 2 x locking casters Suits worksurface depth of 24"-36" | 36" - 48" | UNIFLIP50/S | 593 |
| | | 48" - 60" | UNIFLIP80/S | 612 |
| | | 60" - 72" | UNIFLIP110/S | 635 |
| | | 72" - 96" | UNIFLIP140/S | 659 |

- Select worksurface finish

Laminate

300 (LPL)
 8232
 7981
 8201 (HPL)

@ - Select modesty finish

Powdercoat

S
 W





Desking

| | |
|-----------------------------------|----|
| Agile Plus Overview | 42 |
| Agile Plus | 43 |
| Agile Overview | 46 |
| Agile Winder | 47 |
| Agile Electric | 48 |
| Agile Accessories..... | 50 |
| Axis Overview | 54 |
| Axis Desking | 56 |
| Axis Shared Desking | 58 |
| Axis Shared Workstations | 62 |
| Axis Dividers & Accessories..... | 68 |
| Axis Electrical | 71 |
| Anvil Overview | 72 |
| Anvil Desking..... | 74 |
| Anvil Shared Desking | 76 |
| Anvil Shared Workstations..... | 80 |
| Anvil Dividers & Accessories..... | 86 |
| Anvil Electrical..... | 89 |

Agile Plus Desking

Frames:

Dual synchronized motors with microprocessor control and thermosensor
 Black or Arctic White
 Powdercoat finish to frame
 2.4" square legs
 Flat foot design - single sided desk
 H frame design - double sided desk
 Height adjustable - electric

Worksurfaces:

1" M2 Grade substrate
 4 Melamine finish options
 Matching 2mm PVC edge

Features:

Ultra quiet dual motor frame
 2 controller options, memory presets
 Super soft start stop
 Anti-collision software
 Weight rating: 225lbs
 Electric speed: 1.6"/s

Single Sided Desk

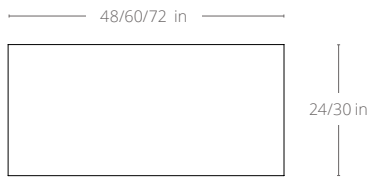

Double Sided Desk

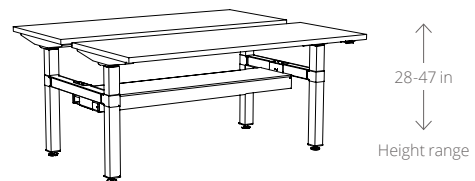
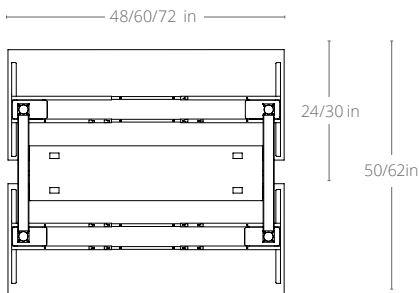



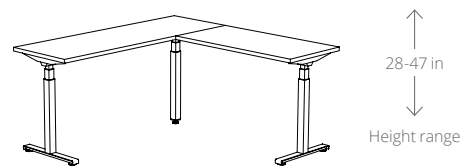
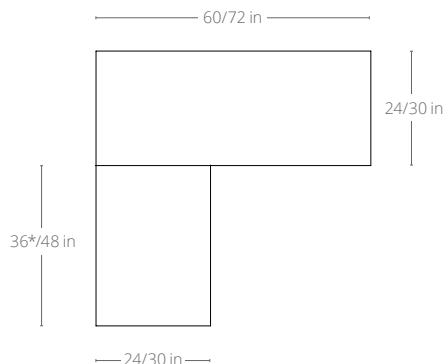

90° Workstation



* 36 in return surface only available in 24 in depth

Agile Plus Desking

Electric height adjustable

| Product | Description | Worktop | Code | LPL | HPL |
|---|---|------------------------|------------------|-------|-------|
|  | Single sided desk Electric adjust | 48" x 24" | AGPE2SSD126/## | 1325 | 1393 |
| | | 48" x 30" | AGPE2SSD1275/## | 1358 | 1449 |
| | | 60" x 24" | AGPE2SSD156/## | 1361 | 1450 |
| | | 60" x 30" | AGPE2SSD1575/## | 1408 | 1516 |
| | | 72" x 24" | AGPE2SSD186/## | 1400 | 1482 |
| | | 72" x 30" | AGPE2SSD1875/## | 1451 | 1585 |
|  | Double sided desk Electric adjust | 2@ 48" x 24" | AGPE2DSD126/## | 2553* | 2689* |
| | | 2@ 48" x 30" | AGPE2DSD1275/## | 2619* | 2801* |
| | | 2@ 60" x 24" | AGPE2DSD156/## | 2625* | 2803* |
| | | 2@ 60" x 30" | AGPE2DSD1575/## | 2719* | 2935* |
| | | 2@ 72" x 24" | AGPE2DSD186/## | 2703* | 2867* |
| | | 2@ 72" x 30" | AGPE2DSD1875/## | 2805* | 3073* |
|  | Single sided desk Frame only Electric adjust | 48" x 24" | AGPE2SSD126/#_F | 1159 | |
| | | 48" x 30" | AGPE2SSD1275/#_F | 1159 | |
| | | 60" x 24" | AGPE2SSD156/#_F | 1159 | |
| | | 60" x 30" | AGPE2SSD1575/#_F | 1159 | |
| | | 72" x 24" | AGPE2SSD186/#_F | 1159 | |
| | | 72" x 30" | AGPE2SSD1875/#_F | 1159 | |
|  | Double sided desk Frame only Electric adjust | 2@ 48" x 24" | AGPE2DSD126/#_F | 1762* | |
| | | 2@ 48" x 30" | AGPE2DSD1275/#_F | 1762* | |
| | | 2@ 60" x 24" | AGPE2DSD156/#_F | 1764* | |
| | | 2@ 60" x 30" | AGPE2DSD1575/#_F | 1764* | |
| | | 2@ 72" x 24" | AGPE2DSD186/#_F | 1841* | |
| | | 2@ 72" x 30" | AGPE2DSD1875/#_F | 1841* | |
|  | Upgrade Modesty panel Laminate | 42.5" wide x 12" deep | AGM12/# | 81 | 107 |
| | | 54.5" wide x 12" deep | AGM15/# | 82 | 109 |
| | | 66.25" wide x 12" deep | AGM18/# | 97 | 128 |

*Price is per back-to-back unit

- Select finishes

Powdercoat



+ Laminate

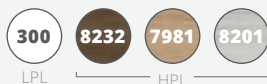

Agile Plus Workstations

Electric height adjustable

| Product | Description | Worktop | Code | LPL | HPL |
|---|---|-----------------------------|---------------------|------|------|
|  | Left hand return 90° Electric adjust | 60' x 24"/36" x 24" | AGP3MEW1561656/#L# | 2323 | 2454 |
| | | 60' x 24"/48" x 24" | AGP3MEW156186/#L# | 2372 | 2529 |
| | | 60' x 30"/36" x 24" | AGP3MEW15751656/#L# | 2370 | 2520 |
| | | 72' x 24"/36" x 24" | AGP3MEW1861656/#L# | 2362 | 2486 |
| | | 72' x 24"/48" x 24" | AGP3MEW186186/#L# | 2411 | 2561 |
| | | 72' x 30"/36" x 24" | AGP3MEW18751656/#L# | 2413 | 2589 |
|  | Right hand return 90° Electric adjust | 60' x 24"/36" x 24" | AGP3MEW1561656/#R# | 2323 | 2454 |
| | | 60' x 24"/48" x 24" | AGP3MEW156186/#R# | 2372 | 2529 |
| | | 60' x 30"/36" x 24" | AGP3MEW15751656/#R# | 2370 | 2520 |
| | | 72' x 24"/36" x 24" | AGP3MEW1861656/#R# | 2362 | 2486 |
| | | 72' x 24"/48" x 24" | AGP3MEW186186/#R# | 2411 | 2561 |
| | | 72' x 30"/36" x 24" | AGP3MEW18751656/#R# | 2413 | 2589 |
|  | 90° Workstation Frame only Electric adjust | 60"-72" x 60"-72" / 24"-30" | AG3MEW18186/#_F | 2004 | |

Controller Upgrade

| | | | |
|---|---|---------|----|
|  | Controller Pro 4 memory presets Electronic display | AGMP4/B | 86 |
|---|---|---------|----|

- Select finishes

Powdercoat



+ Laminate

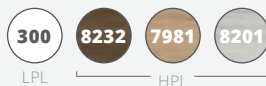

Agile Plus Cable Management

| Product | Description | Dimensions | Code | USD |
|---|--|--------------|---------------|-----|
|  | Cable tray* Single sided | 48" Length | AGPSSDCM12/# | 366 |
| | | 60" Length | AGPSSDCM15/# | 498 |
| | | 72" Length | AGPSSDCM18/# | 531 |
|  | Cable tray* Double sided | 48" Length | AGPDSDCM12/# | 311 |
| | | 60" Length | AGPDSDCM15/# | 344 |
| | | 72" Length | AGPDSDCM18/# | 417 |
|  | Bridge with cover* For single sided desk | | AGPSBRIDGE/# | 99 |
|  | Bridge with cover* For double sided desk | | AGPDBRIDGE/B | 81 |
|  | Cable tray Undermount | 36" Length | ELECTRAY900/# | 193 |
| | Cable cobra | 42.5" Length | CABCOBRA/# | 88 |
| | Cable clutch Set of 5 | | CABCLUTCH_W | 43 |

***Please note:**

Cable trays shown above are only applicable to Agile Plus and not standard Agile. See page 49 for standard Agile cable management.

- Select finish

Colour



Agile Desking

Frames:

Black or Arctic White
 Powdercoat finish to frame
 3.55 x 2.4" legs
 Flat foot design - single
 sided desk
 H frame design - double
 sided desk
 Height adjustable - electric
 or winder

Worksurfaces:

1" M2 Grade substrate
 Studio White Melamine
 finish
 Matching 2mm PVC edge

Features:

Weight rating 250lbs
 Winder speed: ¼"/turn
 Electric speed: 1"/s

Single Sided Desk

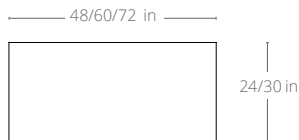

Double Sided Desk

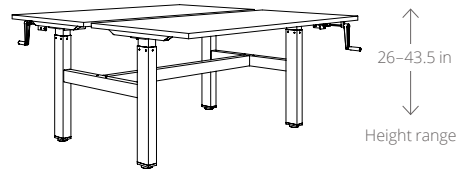
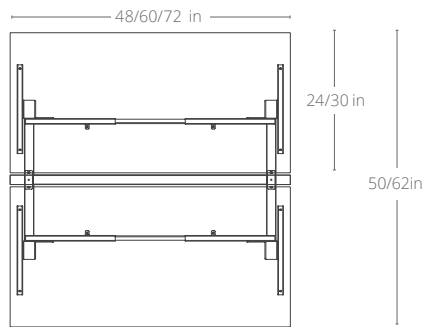

90° Workstation

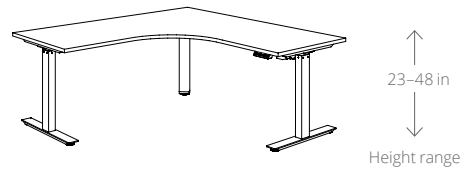
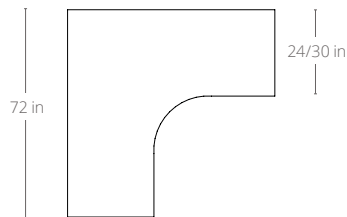

120° Workstation

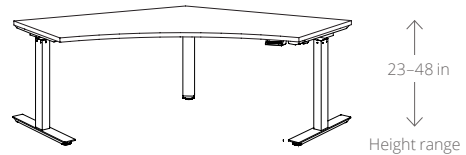
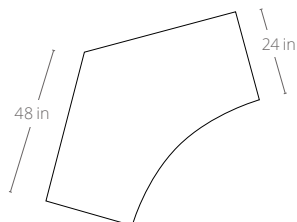

Agile Desking

Winder height adjustable

| Product | Description | Worktop | Code | LPL | HPL |
|---|---|------------------------|----------------|-------|------|
|  | Single sided desk Winder adjust | 48" x 24" | AGWSSD126/## | 953 | 1021 |
| | | 48" x 30" | AGWSSD1275/## | 981 | 1072 |
| | | 60" x 24" | AGWSSD156/## | 1011 | 1100 |
| | | 60" x 30" | AGWSSD1575/## | 1020 | 1128 |
| | | 72" x 24" | AGWSSD186/## | 1042 | 1124 |
| | | 72" x 30" | AGWSSD1875/## | 1084 | 1218 |
|  | Double sided desk Winder adjust | 2@ 48" x 24" | AGWDSD126/## | 2031* | 2167 |
| | | 2@ 48" x 30" | AGWDSD1275/## | 2083* | 2265 |
| | | 2@ 60" x 24" | AGWDSD156/## | 2093* | 2271 |
| | | 2@ 60" x 30" | AGWDSD1575/## | 2166* | 2382 |
| | | 2@ 72" x 24" | AGWDSD186/## | 2228* | 2392 |
| | | 2@ 72" x 30" | AGWDSD1875/## | 2313* | 2581 |
|  | Single sided desk Frame only Winder adjust | 48" x 24" | AGWSSD126/#_F | 820 | |
| | | 48" x 30" | AGWSSD1275/#_F | 820 | |
| | | 60" x 24" | AGWSSD156/#_F | 820 | |
| | | 60" x 30" | AGWSSD1575/#_F | 820 | |
| | | 72" x 24" | AGWSSD186/#_F | 849 | |
| | | 72" x 30" | AGWSSD1875/#_F | 849 | |
|  | Double sided desk Frame only Winder adjust | 2@ 48" x 24" | AGWDSD126/#_F | 1762* | |
| | | 2@ 48" x 30" | AGWDSD1275/#_F | 1762* | |
| | | 2@ 60" x 24" | AGWDSD156/#_F | 1764* | |
| | | 2@ 60" x 30" | AGWDSD1575/#_F | 1764* | |
| | | 2@ 72" x 24" | AGWDSD186/#_F | 1841* | |
| | | 2@ 72" x 30" | AGWDSD1875/#_F | 1841* | |
|  | Upgrade Modesty panel Laminate | 42.5" wide x 12" deep | AGM12/# | 81 | 107 |
| | | 54.5" wide x 12" deep | AGM15/# | 82 | 109 |
| | | 66.25" wide x 12" deep | AGM18/# | 97 | 128 |

*Price is per back-to-back unit

- Select finishes

Powdercoat





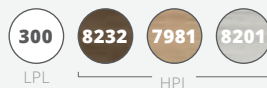

+ Laminate



Agile Desking

Electric height adjustable

| Product | Description | Worktop | Code | LPL | HPL |
|---|---|------------------------|-----------------|-------|-------|
|  | Single sided desk Electric adjust | 48" x 24" | AGE2SSD126/# | 1350 | 1418 |
| | | 48" x 30" | AGE2SSD1275/# | 1379 | 1470 |
| | | 60" x 24" | AGE2SSD156/# | 1380 | 1469 |
| | | 60" x 30" | AGE2SSD1575/# | 1417 | 1525 |
| | | 72" x 24" | AGE2SSD186/# | 1438 | 1520 |
| | | 72" x 30" | AGE2SSD1875/# | 1482 | 1616 |
|  | Double sided desk Electric adjust | 2@ 48" x 24" | AGE2DSD126/# | 2671* | 2807* |
| | | 2@ 48" x 30" | AGE2DSD1275/# | 2727* | 2909* |
| | | 2@ 60" x 24" | AGE2DSD156/# | 2733* | 2911* |
| | | 2@ 60" x 30" | AGE2DSD1575/# | 2807* | 3023* |
| | | 2@ 72" x 24" | AGE2DSD186/# | 2867* | 3031* |
| | | 2@ 72" x 30" | AGE2DSD1875/# | 2954* | 3222* |
|  | Single sided desk Frame only Electric adjust | 48" x 24" | AGE2SSD126/#_F | 1217 | n/a |
| | | 48" x 30" | AGE2SSD1275/#_F | 1217 | n/a |
| | | 60" x 24" | AGE2SSD156/#_F | 1217 | n/a |
| | | 60" x 30" | AGE2SSD1575/#_F | 1217 | n/a |
| | | 72" x 24" | AGE2SSD186/#_F | 1245 | n/a |
| | | 72" x 30" | AGE2SSD1875/#_F | 1245 | n/a |
|  | Double sided desk Frame only Electric adjust | 2@ 48" x 24" | AGE2DSD126/#_F | 2408* | n/a |
| | | 2@ 48" x 30" | AGE2DSD1275/#_F | 2408* | n/a |
| | | 2@ 60" x 24" | AGE2DSD156/#_F | 2410* | n/a |
| | | 2@ 60" x 30" | AGE2DSD1575/#_F | 2410* | n/a |
| | | 2@ 72" x 24" | AGE2DSD186/#_F | 2482* | n/a |
| | | 2@ 72" x 30" | AGE2DSD1875/#_F | 2482* | n/a |
|  | Upgrade Modesty panel Laminate | 42.5" wide x 12" deep | AGM12/W | 81 | 107 |
| | | 54.5" wide x 12" deep | AGM15/W | 82 | 109 |
| | | 66.25" wide x 12" deep | AGM18/W | 97 | 128 |

*Price is per back-to-back unit

- Select finishes

Powdercoat





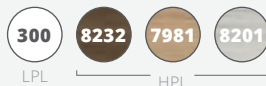

+ Laminate



Agile Workstations

Electric height adjustable

| Product | Description | Worktop | Code | LPL | HPL |
|---|--|-----------------------|--------------------|-------------|-------------|
|  | 90° Workstation - Left Electric adjust | 72" x 72"/24" | AG3MEW18186/#L300 | 2794 | n/a |
| | | 72" x 72"/30" | AG3MEW181875/#L300 | 2824 | n/a |
| | 90° Workstation - Right Electric adjust | 72" x 72"/24" | AG3MEW18186/#R300 | 2794 | n/a |
| | | 72" x 72"/30" | AG3MEW181875/#R300 | 2824 | n/a |
|  | 120° Workstation Electric adjust | 48" x 48"/24" | AG3MEW12126/# | 2804 | 3084 |
|  | 90° Workstation Frame only Electric adjust | 60"-76" x 60"-76"/24" | AG3MEW18186/#_F | 2383 | |
| | | 60"-76" x 60"-76"/30" | AG3MEW181875/#_F | 2383 | |
|  | 120° Workstation Frame only Electric adjust | 48"-72" x 48"-72"/24" | AG3MEW12126/#_F | 2383 | |

- Select finishes





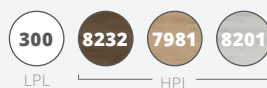

Powdercoat



+ Laminate



Agile e-Panel Screens

| Product | Description | Dimensions | Code | USD |
|---|---|-------------|----------------|-----|
|  | Clamp on Screen* | 47"W x 24"H | EPSSD120060/# | 212 |
| | E-panel .75" thickness <i>*Not for Agile Plus</i> | 59"W x 24"H | EPSSD150060/# | 350 |
|  | Edge Undermount | 47"W x 24"H | AGESE120060/W# | 265 |
| | White bracket E-panel .75" thickness | 59"W x 24"H | AGESE150060/W# | 378 |
|  | Edge Undermount | 47"W x 24"H | AGESE120060/B# | 265 |
| | Black bracket E-panel .75" thickness | 59"W x 24"H | AGESE150060/B# | 378 |
|  | Return Screen | 23"W x 12"H | SSCRN6030/PB10 | 162 |
| | E-panel Pure Black 1" thickness | 29"W x 12"H | SSCRN7530/PB10 | 171 |
|  | Return Screen | 23"W x 12"H | SSCRN6030/SP15 | 162 |
| | E-panel Spectrum Red 1" thickness | 29"W x 12"H | SSCRN7530/SP15 | 171 |
|  | Return Screen | 23"W x 12"H | SSCRN6030/DG37 | 162 |
| | E-panel Deep Grey 1" thickness | 29"W x 12"H | SSCRN7530/DG37 | 171 |
|  | Return Screen | 23"W x 12"H | SSCRN6030/BB21 | 162 |
| | E-panel Bright Blue 1" thickness | 29"W x 12"H | SSCRN7530/BB21 | 171 |

- Select finishes

e-Panel

SP15





DG37

BB21

*Please note:

Spine screens marked (*) are only applicable to standard Agile and not Agile Plus.

Agile Cable Management



| Product | Description | Dimensions | Code | USD |
|---|---|--------------|---------------|-----|
|  | Cable tray* Single sided *Not for Agile Plus | 48" Length | AGSSDCM12/# | 366 |
| | | 60" Length | AGSSDCM15/# | 498 |
| | | 72" Length | AGSSDCM18/# | 531 |
|  | Cable tray* Double sided *Not for Agile Plus | 48" Length | AGDSDCM12/# | 311 |
| | | 60" Length | AGDSDCM15/# | 344 |
| | | 72" Length | AGDSDCM18/# | 417 |
|  | Cable tray Undermount | 36" Length | ELECTRAY900/# | 193 |
|  | Cable cobra | 42.5" Length | CABCOBRA/# | 88 |
|  | Cable clutch Set of 5 | | CABCLUTCH_W | 43 |

***Please note:**
 Cable trays marked (*) are only applicable to standard Agile and not Agile Plus. See page 43 for Agile Plus cable management.

- Select finish

Colour **B** **W**

Agile Brackets





| Product | Description | Dimensions | Code | USD |
|--|--|--------------|------------------|-----|
|  | Brackets (pair) For single sided desk cable tray | 24"-32" deep | AGSSDBRAC/# | 113 |
|  | Bridge with cover For single sided desk | | AGSBRIDGE/#-IT-C | 79 |
|  | Bridge with cover For double sided desk | | AGDBRIDGE/#-1-C | 93 |

- Select finish

Powdercoat



Agile Electrical

| Product | Description | Dimensions | Code | USD |
|---|---|-----------------|------------------|-----|
|  | <p>Voltra Agile I - White 3 outlets 2 USB 108" cord</p> | | AGPM3O2U-W-108 | 219 |
|  | <p>Voltra power module 3 outlets 1 USB-A, 1 USB-C 108" cord</p> | | AGPM3O1U1C-W-108 | 232 |
| | <p>Voltra power module 3 outlets 1 USB-A, 1 USB-C 108" cord</p> | | AGPM3O1U1C-B-108 | 232 |
|  | <p>One Duplex For one duplex in tray</p> | | ELECTRICAL_1 | 188 |
|  | <p>Two Duplex For two duplexes in tray</p> | | ELECTRICAL_2 | 343 |
|  | Base Infeed Hardwire | Standard - 72" | EHINFD-72 | 207 |
| | | NYC - 72" | EHNYCINFD-72 | 207 |
| | Ceiling Infeed Hardwire | Standard - 144" | EHINFD-144 | 249 |
| | | NYC - 144" | EHNYCINFD-144 | 249 |

Please note:
 All electrical prices include all required jumper cables, connecting hardware, duplexes, electrical face plate, and data face plate with four knockouts.

Axis Desking

Frames:

Arctic White or Silver
 Powdercoat finish to frame
 2 x 2" square legs
 2 x 1" rails
 28.75" Worksurface height

Worksurfaces:

1" M2 Grade substrate
 Studio White Melamine finish
 Matching 2mm PVC edge
 90° worksurface comes as with join at 47" along the left or right hand side

Spine Screens:

Translucent or E-panel insert to top 11.82"
 White Melamine below
 0.82" thickness
 Sits 19.7" above desk height
 All brackets & trims included
 E-panel is available in Ignite Red or Black and has a tackable core

Desk

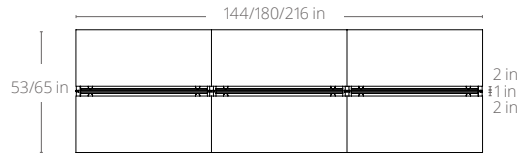
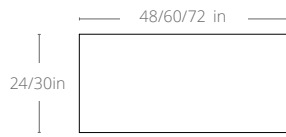

90° Workstation

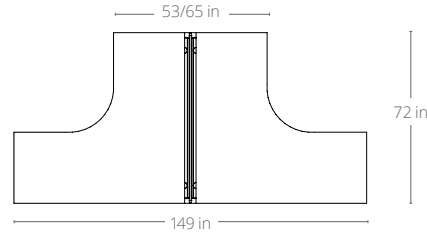
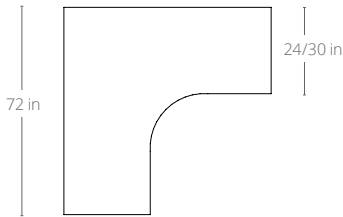

120° Workstation

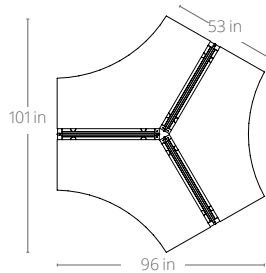
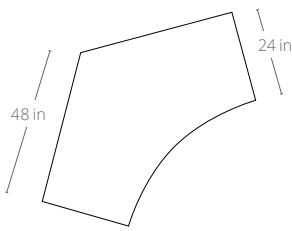

Desk & Return

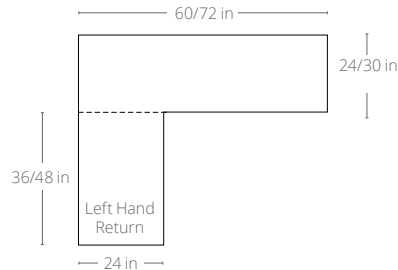

* All dimensions are nominal

Standard Dividers

Spine Screens

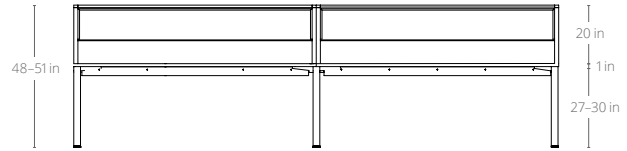
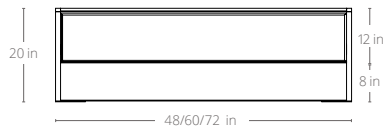

Desk Hung Screens

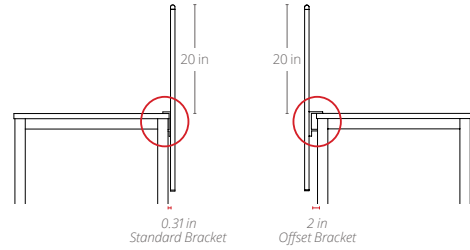
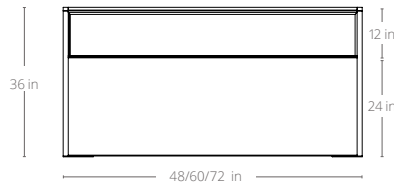

Return Screens

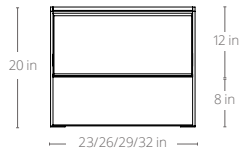

Devise Dividers

Spine Screens

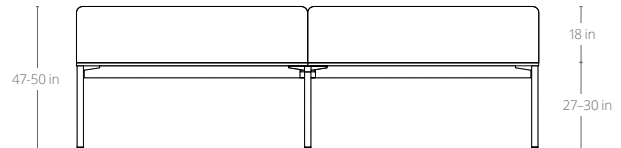
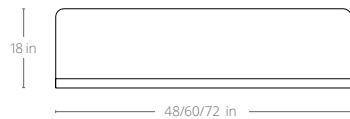

Desk Hung Screens

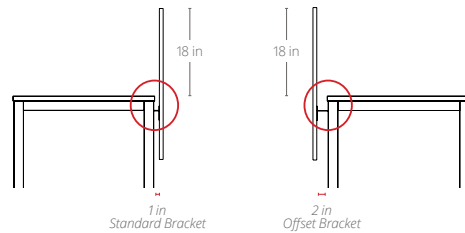



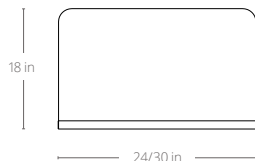

Return Screens



* All dimensions are nominal

Axis Desking

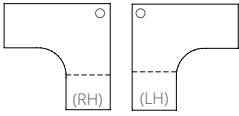

| Product | Description | Worktop | Code | LPL | HPL |
|---|--|--|------------------|------|------|
|  | Desk Fixed height | 48" x 24" | AXSD126/## | 527 | 595 |
| | | 48" x 30" | AXSD1275/### | 598 | 689 |
| | | 60" x 24" | AXSD156/## | 581 | 670 |
| | | 60" x 30" | AXSD1575/### | 661 | 769 |
| | | 72" x 24" | AXSD186/## | 628 | 710 |
| | | 72" x 30" | AXSD1875/### | 715 | 849 |
| | | 72" x 36" <i>Includes 6" conference front</i> | AXSD189/## | 720 | 889 |
|  | 90° Workstation Fixed height | 72" x 72"/24" | AX9W18186/#L300 | 1053 | |
| | | 72" x 72"/24" | AX9W18186/#R300 | 1053 | |
| | | 72" x 72"/30" | AX9W181875/#L300 | 1106 | |
| | | 72" x 72"/30" | AX9W181875/#R300 | 1106 | |
|  | 120° Workstation Fixed height | 48" x 48"/24" | AX12W12126/## | 1194 | 1474 |
|  | Upgrade Modesty panel Laminate | 42.5" wide x 12" deep | AXM12/# | 87 | 113 |
| | | 54.5" wide x 12" deep | AXM15/# | 90 | 117 |
| | | 66.25" wide x 12" deep | AXM18/# | 104 | 135 |



- Select finishes

Powdercoat frame **S** **W** + Laminate **300** **8232** **7981** **8201**
LPL HPL

Axis Desk & Return

| Product | Description | Worktop | Code | LPL | HPL |
|---|--|--|-----------------|------|------|
|  | Left hand return Fixed height | 60" x 24"/36" x 24" | AXDR156156/#L# | 847 | 978 |
| | | 60" x 30"/36" x 24" <i>Includes 6" conference front</i> | AXDR1575176/#L# | 1227 | 1377 |
| | | 60" x 24"/48" x 24" | AXDR156186/#L# | 905 | 1062 |
| | | 60" x 30"/48" x 24" <i>Includes 6" conference front</i> | AXDR1575206/#L# | 1294 | 1470 |
| | | 72" x 24"/36" x 24" | AXDR186156/#L# | 895 | 1019 |
| | | 72" x 30"/36" x 24" <i>Includes 6" conference front</i> | AXDR1875176/#L# | 1282 | 1458 |
| | | 72" x 24"/48" x 24" | AXDR186186/#L# | 955 | 1105 |
| | | 72" x 30"/48" x 24" <i>Includes 6" conference front</i> | AXDR1875206/#L# | 1348 | 1550 |
|  | Right hand return Fixed height | 60" x 24"/36" x 24" | AXDR156156/#R# | 847 | 978 |
| | | 60" x 30"/36" x 24" <i>Includes 6" conference front</i> | AXDR1575176/#R# | 1227 | 1377 |
| | | 60" x 24"/48" x 24" | AXDR156186/#R# | 905 | 1062 |
| | | 60" x 30"/48" x 24" <i>Includes 6" conference front</i> | AXDR1575206/#R# | 1294 | 1470 |
| | | 72" x 24"/36" x 24" | AXDR186156/#R# | 895 | 1019 |
| | | 72" x 30"/36" x 24" <i>Includes 6" conference front</i> | AXDR1875176/#R# | 1282 | 1458 |
| | | 72" x 24"/48" x 24" | AXDR186186/#R# | 955 | 1105 |
| | | 72" x 30"/48" x 24" <i>Includes 6" conference front</i> | AXDR1875206/#R# | 1348 | 1550 |
|  | Upgrade Modesty panel Laminate | 42.5" wide x 12" deep | AXM12/# | 87 | 113 |
| | | 54.5" wide x 12" deep | AXM15/# | 90 | 117 |
| | | 66.25" wide x 12" deep | AXM18/# | 104 | 135 |

- Select finishes



Powdercoat frame

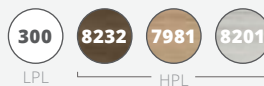

+ Laminate



Axis Shared Desking

| Product | Description | Worktop | Code | LPL* | HPL* |
|---|--|------------------------|----------------|------|------|
|  | Desk Single sided 2 User | 2 @ 48" x 24" | AX2SSD126/### | 942 | 1078 |
| | | 2 @ 48" x 30" | AX2SSD1275/### | 1071 | 1253 |
| | | 2 @ 60" x 24" | AX2SSD156/### | 1048 | 1226 |
| | | 2 @ 60" x 30" | AX2SSD1575/### | 1199 | 1415 |
| | | 2 @ 72" x 24" | AX2SSD186/### | 1145 | 1309 |
| | | 2 @ 72" x 30" | AX2SSD1875/### | 1309 | 1577 |
|  | Desk Single sided 3 User | 3 @ 48" x 24" | AX3SSD126/### | 1357 | 1561 |
| | | 3 @ 48" x 30" | AX3SSD1275/### | 1544 | 1817 |
| | | 3 @ 60" x 24" | AX3SSD156/### | 1519 | 1786 |
| | | 3 @ 60" x 30" | AX3SSD1575/### | 1742 | 2066 |
| | | 3 @ 72" x 24" | AX3SSD186/### | 1659 | 1905 |
| | | 3 @ 72" x 30" | AX3SSD1875/### | 1904 | 2306 |
|  | Upgrade Modesty panel Laminate | 42.5" wide x 12" deep | AXM12/# | 87 | 113 |
| | | 54.5" wide x 12" deep | AXM15/# | 90 | 117 |
| | | 66.25" wide x 12" deep | AXM18/# | 104 | 135 |

*All shared desking shows pricing per pod.



Please note:
 Single sided desk cable management can be found on page 102

- Select finishes

Powdercoat frame S W + Laminate 300 8232 7981 8201

LPL
←
HPL
→

Axis Shared Desking

| Product | Description | Worktop | Code | LPL* | HPL* |
|---|--|---------------|----------------|------|------|
|  | Desk Double sided 2 User Cable trays | 2 @ 48" x 24" | AX2DSD126/### | 1178 | 1314 |
| | | 2 @ 48" x 30" | AX2DSD1275/### | 1276 | 1458 |
| | | 2 @ 60" x 24" | AX2DSD156/### | 1321 | 1499 |
| | | 2 @ 60" x 30" | AX2DSD1575/### | 1443 | 1659 |
| | | 2 @ 72" x 24" | AX2DSD186/### | 1468 | 1632 |
| | | 2 @ 72" x 30" | AX2DSD1875/### | 1599 | 1867 |
|  | Desk Double sided 4 User Cable trays | 4 @ 48" x 24" | AX4DSD126/### | 2079 | 2351 |
| | | 4 @ 48" x 30" | AX4DSD1275/### | 2249 | 2613 |
| | | 4 @ 60" x 24" | AX4DSD156/### | 2360 | 2716 |
| | | 4 @ 60" x 30" | AX4DSD1575/### | 2571 | 3003 |
| | | 4 @ 72" x 24" | AX4DSD186/### | 2650 | 2978 |
| | | 4 @ 72" x 30" | AX4DSD1875/### | 2890 | 3426 |
|  | Desk Double sided 6 User Cable trays | 6 @ 48" x 24" | AX6DSD126/### | 2975 | 3383 |
| | | 6 @ 48" x 30" | AX6DSD1275/### | 3236 | 3782 |
| | | 6 @ 60" x 24" | AX6DSD156/### | 3404 | 3938 |
| | | 6 @ 60" x 30" | AX6DSD1575/### | 3714 | 4362 |
| | | 6 @ 72" x 24" | AX6DSD186/### | 3838 | 4330 |
| | | 6 @ 72" x 30" | AX6DSD1875/### | 4174 | 4978 |

*All shared desking shows pricing per pod.

Please note:

Cable tray covers can be found on page 103

- Select finishes

Powdercoat frame



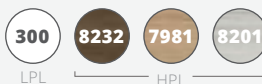

+ Laminate



Axis Shared Desking

With standard screens

| Product | Description | Worktop | Code | LPL* | HPL* |
|--|-------------|---------------|----------------|------|------|
|  <p>Desk Double sided 2 User Spine screens Cable trays</p> | | 2 @ 48" x 24" | AX2DSD126/### | 1468 | 1604 |
| | | 2 @ 48" x 30" | AX2DSD1275/### | 1565 | 1747 |
| | | 2 @ 60" x 24" | AX2DSD156/### | 1692 | 1870 |
| | | 2 @ 60" x 30" | AX2DSD1575/### | 1812 | 2028 |
| | | 2 @ 72" x 24" | AX2DSD186/### | 1882 | 2046 |
| | | 2 @ 72" x 30" | AX2DSD1875/### | 2017 | 2285 |
|  <p>Desk Double sided 4 User Spine screens Cable trays</p> | | 4 @ 48" x 24" | AX4DSD126/### | 2683 | 2955 |
| | | 4 @ 48" x 30" | AX4DSD1275/### | 2849 | 3213 |
| | | 4 @ 60" x 24" | AX4DSD156/### | 3130 | 3486 |
| | | 4 @ 60" x 30" | AX4DSD1575/### | 3337 | 3769 |
| | | 4 @ 72" x 24" | AX4DSD186/### | 3515 | 3843 |
| | | 4 @ 72" x 30" | AX4DSD1875/### | 3751 | 4287 |
|  <p>Desk Double sided 6 User Spine screens Cable trays</p> | | 6 @ 48" x 24" | AX6DSD126/### | 3888 | 4296 |
| | | 6 @ 48" x 30" | AX6DSD1275/### | 4136 | 4682 |
| | | 6 @ 60" x 24" | AX6DSD156/### | 4565 | 5099 |
| | | 6 @ 60" x 30" | AX6DSD1575/### | 4882 | 5530 |
| | | 6 @ 72" x 24" | AX6DSD186/### | 5149 | 5641 |
| | | 6 @ 72" x 30" | AX6DSD1875/### | 5484 | 6288 |

*All shared desking shows pricing per pod.

Please note:

Comseal covers can be found on page 102



- Select finishes

Powdercoat frame (desk)
S
W
 + **Laminate**
300
8232
7981
8201
 + **Screen insert**
I
B
T

LPL
HPL
e-Panel
PVC

Axis Shared Desking

With Devise screens

| Product | Description | Worktop | Code | LPL* | HPL* |
|---|---|---------------|----------------|------|------|
|  | Desk Double sided 2 User Spine screens Cable trays | 2 @ 48" x 24" | AX2DSD126/### | 1651 | 1787 |
| | | 2 @ 48" x 30" | AX2DSD1275/### | 1761 | 1943 |
| | | 2 @ 60" x 24" | AX2DSD156/### | 1903 | 2081 |
| | | 2 @ 60" x 30" | AX2DSD1575/### | 2037 | 2253 |
| | | 2 @ 72" x 24" | AX2DSD186/### | 2117 | 2281 |
| | | 2 @ 72" x 30" | AX2DSD1875/### | 2268 | 2536 |
|  | Desk Double sided 4 User Spine screens Cable trays | 4 @ 48" x 24" | AX4DSD126/### | 3019 | 3291 |
| | | 4 @ 48" x 30" | AX4DSD1275/### | 3205 | 3569 |
| | | 4 @ 60" x 24" | AX4DSD156/### | 3522 | 3878 |
| | | 4 @ 60" x 30" | AX4DSD1575/### | 3754 | 4186 |
| | | 4 @ 72" x 24" | AX4DSD186/### | 3954 | 4282 |
| | | 4 @ 72" x 30" | AX4DSD1875/### | 4220 | 4756 |
|  | Desk Double sided 6 User Spine screens Cable trays | 6 @ 48" x 24" | AX6DSD126/### | 4373 | 4781 |
| | | 6 @ 48" x 30" | AX6DSD1275/### | 4653 | 5199 |
| | | 6 @ 60" x 24" | AX6DSD156/### | 5135 | 5669 |
| | | 6 @ 60" x 30" | AX6DSD1575/### | 5491 | 6139 |
| | | 6 @ 72" x 24" | AX6DSD186/### | 5791 | 6283 |
| | | 6 @ 72" x 30" | AX6DSD1875/### | 6169 | 6973 |

*All shared desking shows pricing per pod.

Please note:

Eclipse tray covers can be found on page 69

- Select finishes

Powdercoat frame (desk)



+ Laminate







+ E-Panel Color



LPL HPL

Axis 90° Workstations

| Product | Description | Worktop | Code | LPL* | HPL* |
|---|---|---------------------|----------------|-------|-------|
|  | 90° Workstation 2 User | 2 @ 72" x 72" x 24" | AX2U186186/## | 1780 | 2080 |
| | | 2 @ 72" x 72" x 30" | AX2U187187/## | 1990 | 2440 |
|  | 90° Workstation T layout 2 User Cable trays | 2 @ 72" x 72" x 24" | AX2T186186/## | 2169 | 2469 |
| | | 2 @ 72" x 72" x 30" | AX2T187187/## | 2371 | 2821 |
|  | 90° Workstation Plus layout 4 User Cable trays | 4 @ 72" x 72" x 24" | AX4P186186/## | 4892 | 5492 |
| | | 4 @ 72" x 72" x 30" | AX4P187187/## | 5259 | 6159 |
|  | 90° Workstation H layout 4 User Cable trays | 4 @ 72" x 72" x 24" | AX4H186186/## | 4055 | 4655 |
| | | 4 @ 72" x 72" x 30" | AX4H187187/## | 4431 | 5331 |
|  | 90° Workstation 6 User Cable trays | 6 @ 72" x 72" x 24" | AX6PT186186/## | 6766 | 7666 |
| | | 6 @ 72" x 72" x 30" | AX6PT187187/## | 7322 | 8672 |
|  | 90° Workstation Double plus layout 8 User Cable trays | 8 @ 72" x 72" x 24" | AX8P186186/## | 9510 | 10710 |
| | | 8 @ 72" x 72" x 30" | AX8P187187/## | 10202 | 12002 |

*All shared desking shows pricing per pod.

Please note:

Cable tray covers can be found on page 103

- Select finishes

Powdercoat frame





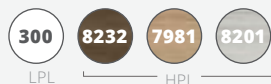

+ **Laminate**



Axis 90° Workstations

With standard screens

| Product | Description | Worktop | Code | LPL* | HPL* |
|---|---|---------------------|-----------------|--------------|--------------|
|  | 90° Workstation T layout 2 User Spine screens | 2 @ 72" x 72" x 24" | AX2T18186/### | 2583 | 2883 |
| | Cable trays | 2 @ 72" x 72" x 30" | AX2T181875/### | 2785 | 3235 |
|  | 90° Workstation Plus layout 4 User Spine screens | 4 @ 72" x 72" x 24" | AX4P18186/### | 6548 | 7148 |
| | Cable trays | 4 @ 72" x 72" x 30" | AX4P181875/### | 6910 | 7810 |
|  | 90° Workstation H layout 4 User Spine screens | 4 @ 72" x 72" x 24" | AX4H18186/### | 4925 | 5525 |
| | Cable trays | 4 @ 72" x 72" x 30" | AX4H181875/### | 5296 | 6196 |
|  | 90° Workstation 6 User Spine screens | 6 @ 72" x 72" x 24" | AX6PT18186/### | 8877 | 9777 |
| | Cable trays | 6 @ 72" x 72" x 30" | AX6PT181875/### | 9421 | 10771 |
|  | 90° Workstation Double plus layout 8 User Spine screens | 8 @ 72" x 72" x 24" | AX8P18186/### | 12838 | 14038 |
| | Cable trays | 8 @ 72" x 72" x 30" | AX8P181875/### | 13547 | 15347 |

*All shared desking shows pricing per pod.

Please note:

Comseal covers can be found on page 102

- Select finishes

Powdercoat frame (desk)



+

Laminate



+

Screen insert



← e-Panel →

PVC

Axis 90° Workstations

With Devise screens

| Product | Description | Worktop | Code | LPL* | HPL* |
|---|---|---------------------|-----------------|--------------|--------------|
|  | 90° Workstation T layout 2 User Spine screens | 2 @ 72" x 72" x 24" | AX2T18186/### | 2930 | 3230 |
| | Cable trays | 2 @ 72" x 72" x 30" | AX2T187187/### | 3148 | 3598 |
|  | 90° Workstation Plus layout 4 User Spine screens | 4 @ 72" x 72" x 24" | AX4P186186/### | 7417 | 8017 |
| | Cable trays | 4 @ 72" x 72" x 30" | AX4P187187/### | 7805 | 8705 |
|  | 90° Workstation H layout 4 User Spine screens | 4 @ 72" x 72" x 24" | AX4H186186/### | 5591 | 6191 |
| | Cable trays | 4 @ 72" x 72" x 30" | AX4H187187/### | 5988 | 6888 |
|  | 90° Workstation 6 User Spine screens | 6 @ 72" x 72" x 24" | AX6PT186186/### | 10063 | 10963 |
| | Cable trays | 6 @ 72" x 72" x 30" | AX6PT187187/### | 10645 | 11995 |
|  | 90° Workstation Double plus layout 8 User Spine screens | 8 @ 72" x 72" x 24" | AX8P186186/### | 14545 | 15745 |
| | Cable trays | 8 @ 72" x 72" x 30" | AX8P187187/### | 15301 | 17101 |

*All shared desking shows pricing per pod.

Please note:

Eclipse tray covers can be found on page 69

- Select finishes

Powdercoat frame (desk)



+ Laminate







+ E-Panel Color



LPL ————— HPL

Axis 120° Workstations

| Product | Description | Worktop | Code | LPL* | HPL* |
|---|---|----------------------|----------------|-------|-------|
|  | 120° Workstation 3 User Cable trays | 3 @ 48" x 48" x 24" | AX3SW12126/## | 3761 | 4043 |
|  | 120° Workstation 6 User Cable trays | 6 @ 48" x 48" x 24" | AX6SW12126/## | 7521 | 8086 |
|  | 120° Workstation 9 User Cable trays | 9 @ 48" x 48" x 24" | AX9SW12126/## | 11281 | 12129 |
|  | 120° Workstation 12 User Cable trays | 12 @ 48" x 48" x 24" | AX12SW12126/## | 15041 | 16171 |
|  | 120° Workstation 18 User Cable trays | 18 @ 48" x 48" x 24" | AX18SW12126/## | 22561 | 24257 |

*All shared desking shows pricing per pod.

Please note:

Cable tray covers can be found on page 103

- Select finishes

Powdercoat frame



+ **Laminate**

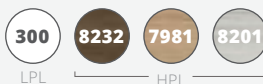

Axis 120° Workstations

With standard screens

| Product | Description | Worktop | Code | LPL* | HPL* |
|---|--|----------------------|-----------------|-------|-------|
|  | 120° Workstation 3 User Spine screens Cable trays | 3 @ 48" x 48" x 24" | AX3SW12126/### | 4546 | 5080 |
|  | 120° Workstation 6 User Spine screens Cable trays | 6 @ 48" x 48" x 24" | AX6SW12126/### | 9092 | 10160 |
|  | 120° Workstation 9 User Spine screens Cable trays | 9 @ 48" x 48" x 24" | AX9SW12126/### | 13638 | 16158 |
|  | 120° Workstation 12 User Spine screens Cable trays | 12 @ 48" x 48" x 24" | AX12SW12126/### | 18183 | 21543 |
|  | 120° Workstation 18 User Spine screens Cable trays | 18 @ 48" x 48" x 24" | AX18SW12126/### | 27275 | 32315 |

*All shared desking shows pricing per pod.

Please note:

Comseal covers can be found on page 102

- Select finishes

Powdercoat frame (desk)
S
W
 + **Laminate**
300
8232
7981
8201
 + **Screen insert**
I
B
T

LPL
HPL
e-Panel
PVC

Axis 120° Workstations

With Devise screens

| Product | Description | Worktop | Code | LPL* | HPL* |
|---|--|----------------------|-----------------|-------|-------|
|  | 120° Workstation 3 User Spine screens Cable trays | 3 @ 48" x 48" x 24" | AX3SW12126/### | 5114 | 5715 |
|  | 120° Workstation 6 User Spine screens Cable trays | 6 @ 48" x 48" x 24" | AX6SW12126/### | 10228 | 11430 |
|  | 120° Workstation 9 User Spine screens Cable trays | 9 @ 48" x 48" x 24" | AX9SW12126/### | 15342 | 17144 |
|  | 120° Workstation 12 User Spine screens Cable trays | 12 @ 48" x 48" x 24" | AX12SW12126/### | 20456 | 22860 |
|  | 120° Workstation 18 User Spine screens Cable trays | 18 @ 48" x 48" x 24" | AX18SW12126/### | 30684 | 34289 |

*All shared desking shows pricing per pod.

Please note:

Eclipse tray covers can be found on page 69

- Select finishes

Powdercoat frame (desk)

S
W
+
Laminate

300
8232
7981
8201
+
E-Panel Color

DBL
DCH
DGR

LPL
HPL

Axis Desk Hung Screens

| Product | Description | Dimensions | Code | USD |
|---|------------------|----------------|-------------|-----|
|  | Desk hung screen | 48" x 36" high | AXHS12OFF/# | 505 |
| | | 60" x 36" high | AXHS15OFF/# | 657 |
| | | 72" x 36" high | AXHS18OFF/# | 696 |
| | | 48" x 36" high | AXHS12/# | 475 |
| | | 60" x 36" high | AXHS15/# | 626 |
| | | 72" x 36" high | AXHS18/# | 665 |

Please note:

Offset Bracket code (OFF) is for screens used on single sided Axis Straightline workstations.

- Select screen insert

E-panel



OR Translucent

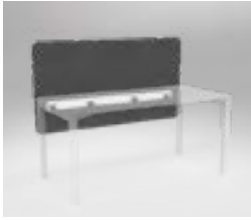

Axis Desk Hung Screens

| Product | Description | Dimensions | Code | USD |
|---|------------------|----------------|------------|-----|
|  | Desk hung screen | 48" x 36" high | DHS48OFF/# | 688 |
| | | 60" x 36" high | DHS60OFF/# | 555 |
| | | 72" x 36" high | DHS72OFF/# | 765 |
| | | 48" x 36" high | DHS48/# | 522 |
| | | 60" x 36" high | DHS60/# | 731 |
| | | 72" x 36" high | DHS72/# | 722 |

Please note:



Offset Bracket code (OFF) is for screens used on single sided Axis Straightline workstations.

- Select Screen Colour



E-panel



Standard Return Screens

| Product | Description | Dimensions | Code | USD |
|--|--|----------------|------------|-----|
|  | Return screen Single sided desks | 23" x 20" high | AXSRS58/# | 179 |
| | | 29" x 20" high | AXSRS73/# | 196 |
|  | Return screen Double sided desks | 26" x 20" high | AXRS65/# | 165 |
| | | 32" x 20" high | AXRS80/# | 194 |
|  | Return screen Double sided desks end of run | 26" x 20" high | AXRS65/#_E | 181 |
| | | 32" x 20" high | AXRS80/#_E | 213 |

Devise Return Screens

| Product | Description | Dimensions | Code | USD |
|---|--|----------------|-----------|-----|
|  | Return screen Single and double sided desks | 23" x 12" high | DRS5931/# | 159 |
| | | 29" x 12" high | DRS7431/# | 187 |
|  | Return screen Single and double sided desks | 23" x 18" high | DRS5946/# | 193 |
| | | 29" x 18" high | DRS7446/# | 225 |

- Select Standard Screen Insert

E-panel



OR

Translucent







- Select Devise Screen Colour

E-panel



Axis Electrical

| Product | Description | Dimensions | Code | USD |
|---|---|-----------------|------------------|-----|
|  | Voltra - White 3 outlets, 1 USB-A, 1 USB-C 108" cord | | AXPM301U1C-W-108 | 232 |
| | Voltra - Black 3 outlets, 1 USB-A, 1 USB-C 108" cord | | AXPM301U1C-B-108 | 232 |
|  | One Duplex For one duplex in tray | | ELECTRICAL_1 | 188 |
|  | Two Duplex For two duplexes in tray | | ELECTRICAL_2 | 343 |
|  | Base Infeed Hardwire | Standard - 72" | EHINFD-72 | 207 |
| | | NYC - 72" | EHNYCINFD-72 | 207 |
| | Ceiling Infeed Hardwire | Standard - 144" | EHINFD-144 | 249 |
| | | NYC - 144" | EHNYCINFD-144 | 249 |

Accessories

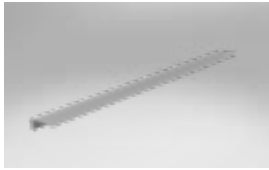
| Product | Description | Dimensions | Code | USD |
|---|---|------------|--------|-----|
|  | Eclipse Tray Tidy Flexible PVC tray cover | 48" | ECTT48 | 74 |
| | | 60" | ECTT60 | 94 |
| | | 72" | ECTT72 | 111 |

Please note:

- All electrical prices include all required jumper cables, connecting hardware, duplexes, electrical face plate, and data face plate with four knockouts
- Single-sided desks can only have below desk electrical, and double sided desks can only have above desk electrical.

Anvil Desking

Frames:

Arctic White Powdercoat finish to frame
 2 x 2 x 2" triangle legs
 2 x 1" rails
 28.75" Worksurface height

Worksurfaces:

1" M2 Grade substrate
 Studio White Melamine finish
 Matching 2mm PVC edge
 90° worksurface comes as with join at 47" along the left or right hand side
 Double sided desks include comseal covers

Spine Screens:

Translucent or E-panel insert to top 11.82"
 White Melamine below
 0.82" thickness
 Sits 19.7" above desk height
 All brackets & trims included
 E-panel is available in Ignite Red or Black and has a tackable core

Desk

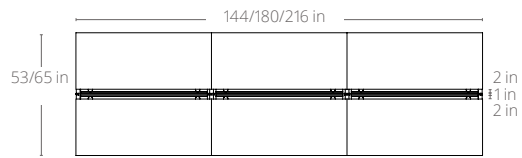

90° Workstation

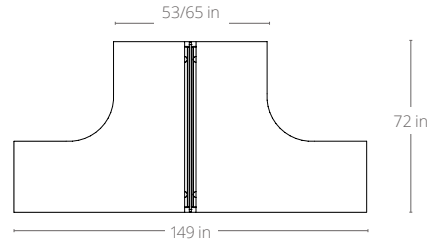
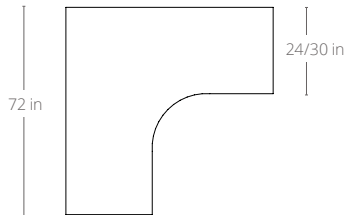

120° Workstation

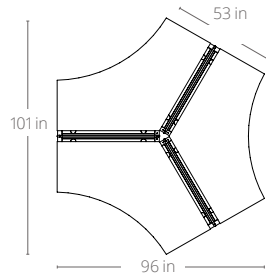
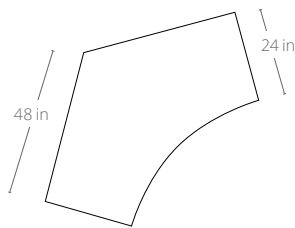

Desk & Return

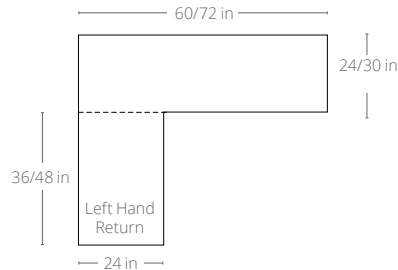

Standard Dividers

Spine Screens

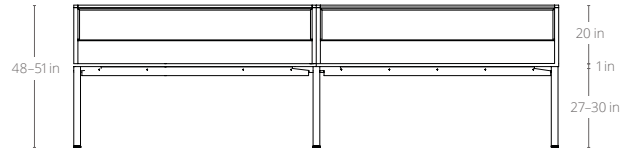
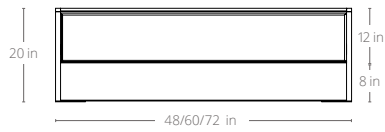

Desk Hung Screens

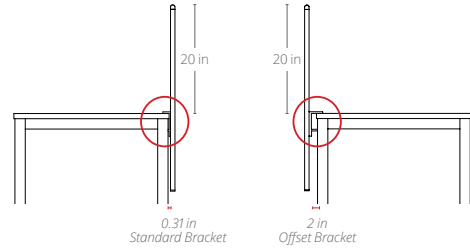
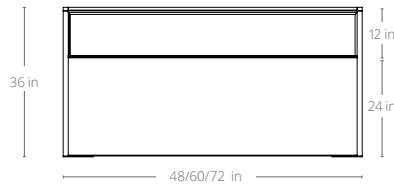

Return Screens

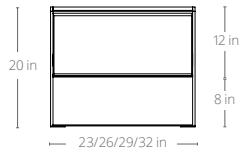

Devise Dividers

Spine Screens

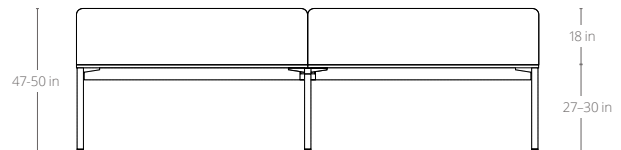
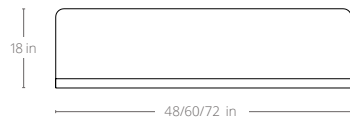

Desk Hung Screens

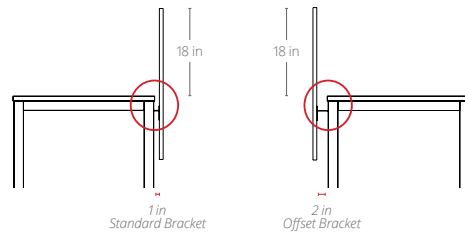
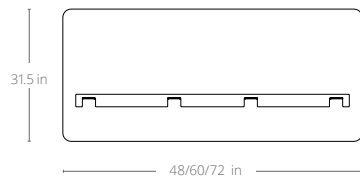

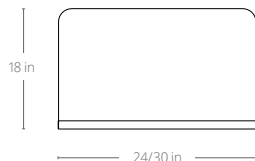

Return Screens



* All dimensions are nominal

Anvil Desking



| Product | Description | Worktop | Code | LPL | HPL |
|---|--|--|----------------|------|------|
|  | Desk Fixed height | 48" x 24" | ANSD126/W# | 631 | 699 |
| | | 48" x 30" | ANSD1275/W# | 746 | 837 |
| | | 60" x 24" | ANSD156/W# | 682 | 771 |
| | | 60" x 30" | ANSD1575/W# | 807 | 915 |
| | | 72" x 24" | ANSD186/W# | 730 | 812 |
| | | 72" x 30" | ANSD1875/W# | 860 | 994 |
| | | 72" x 36" <i>Includes 6" conference front</i> | ANSD1890/W# | 865 | 1034 |
|  | 90° Workstation Fixed height | 72" x 72"/24" | AN9W18186/WL# | 1140 | |
| | | 72" x 72"/24" | AN9W18186/WR# | 1140 | |
| | | 72" x 72"/30" | AN9W181875/WL# | 1260 | |
| | | 72" x 72"/30" | AN9W181875/WR# | 1260 | |
|  | 120° Workstation Fixed height | 48" x 48"/24" | AN12W12126/W# | 1150 | 1430 |
|  | Upgrade Modesty panel Laminate | 42.5" wide x 12" deep | AXM12/# | 87 | 113 |
| | | 54.5" wide x 12" deep | AXM15/# | 90 | 117 |
| | | 66.25" wide x 12" deep | AXM18/# | 104 | 135 |

- Select Worksurface Finish

Worksurface
300
8232
7981
8201

LPL
HPL

Anvil Desk & Return



| Product | Description | Worktop | Code | LPL | HPL |
|--|-------------|--|-----------------|------|------|
|  <p>Left hand return Fixed height</p> | | 60" x 24"/36" x 24" | ANDR156156/WL# | 940 | 978 |
| | | 60" x 30"/36" x 24" <i>Includes 6" conference front</i> | ANDR1575176/WL# | 1470 | 1377 |
| | | 60" x 24"/48" x 24" | ANDR156186/WL# | 998 | 1062 |
| | | 60" x 30"/48" x 24" <i>Includes 6" conference front</i> | ANDR1575206/WL# | 1534 | 1470 |
| | | 72" x 24"/36" x 24" | ANDR186156/WL# | 989 | 1019 |
| | | 72" x 30"/36" x 24" <i>Includes 6" conference front</i> | ANDR1875176/WL# | 1523 | 1458 |
| | | 72" x 24"/48" x 24" | ANDR186186/WL# | 1045 | 1105 |
| | | 72" x 30"/48" x 24" <i>Includes 6" conference front</i> | ANDR1875206/WL# | 1586 | 1550 |
|  <p>Right hand return Fixed height</p> | | 60" x 24"/36" x 24" | ANDR156156/WR# | 940 | 978 |
| | | 60" x 30"/36" x 24" <i>Includes 6" conference front</i> | ANDR1575176/WR# | 1470 | 1377 |
| | | 60" x 24"/48" x 24" | ANDR156186/WR# | 998 | 1062 |
| | | 60" x 30"/48" x 24" <i>Includes 6" conference front</i> | ANDR1575206/WR# | 1534 | 1470 |
| | | 72" x 24"/36" x 24" | ANDR186156/WR# | 989 | 1019 |
| | | 72" x 30"/36" x 24" <i>Includes 6" conference front</i> | ANDR1875176/WR# | 1523 | 1458 |
| | | 72" x 24"/48" x 24" | ANDR186186/WR# | 1045 | 1105 |
| | | 72" x 30"/48" x 24" <i>Includes 6" conference front</i> | ANDR1875206/WR# | 1586 | 1550 |
|  <p>Upgrade Modesty panel Laminate</p> | | 42.5" wide x 12" deep | AXM12/# | 87 | 113 |
| | | 54.5" wide x 12" deep | AXM15/# | 90 | 117 |
| | | 66.25" wide x 12" deep | AXM18/# | 104 | 135 |

- Select Worksurface Finish

Worksurface 300 8232 7981 8201

LPL HPL

Anvil Shared Desking

| Product | Description | Worktop | Code | LPL* | HPL* |
|---|--|------------------------|---------------|------|------|
|  | Desk Single sided 2 User | 2 @ 48" x 24" | AN2SSD126/W# | 1044 | 1180 |
| | | 2 @ 48" x 30" | AN2SSD1275/W# | 1220 | 1402 |
| | | 2 @ 60" x 24" | AN2SSD156/W# | 1143 | 1321 |
| | | 2 @ 60" x 30" | AN2SSD1575/W# | 1348 | 1564 |
| | | 2 @ 72" x 24" | AN2SSD186/W# | 1240 | 1404 |
| | | 2 @ 72" x 30" | AN2SSD1875/W# | 1452 | 1720 |
|  | Desk Single sided 3 User | 3 @ 48" x 24" | AN3SSD126/W# | 1457 | 1661 |
| | | 3 @ 48" x 30" | AN3SSD1275/W# | 1696 | 1969 |
| | | 3 @ 60" x 24" | AN3SSD156/W# | 1606 | 1873 |
| | | 3 @ 60" x 30" | AN3SSD1575/W# | 1879 | 2203 |
| | | 3 @ 72" x 24" | AN3SSD186/W# | 1752 | 1998 |
| | | 3 @ 72" x 30" | AN3SSD1875/W# | 2040 | 2442 |
|  | Upgrade Modesty panel Laminate | 42.5" wide x 12" deep | AXM12/# | 87 | 113 |
| | | 54.5" wide x 12" deep | AXM15/# | 90 | 117 |
| | | 66.25" wide x 12" deep | AXM18/# | 104 | 135 |

*All shared desking shows pricing per pod.

Please note:



Single sided desk cable management can be found on page 102

- Select Worksurface Finish

Worksurface 300 8232 7981 8201

LPL HPL

Anwil Shared Desking

| Product | Description | Worktop | Code | LPL* | HPL* |
|---|--|---------------|---------------|------|------|
|  | Desk Double sided 2 User Cable trays | 2 @ 48" x 24" | AN2DSD126/W# | 1317 | 1453 |
| | | 2 @ 48" x 30" | AN2DSD1275/W# | 1491 | 1673 |
| | | 2 @ 60" x 24" | AN2DSD156/W# | 1458 | 1636 |
| | | 2 @ 60" x 30" | AN2DSD1575/W# | 1640 | 1856 |
| | | 2 @ 72" x 24" | AN2DSD186/W# | 1725 | 1889 |
| | | 2 @ 72" x 30" | AN2DSD1875/W# | 1783 | 2051 |
|  | Desk Double sided 4 User Cable trays | 4 @ 48" x 24" | AN4DSD126/W# | 2203 | 2475 |
| | | 4 @ 48" x 30" | AN4DSD1275/W# | 2489 | 2853 |
| | | 4 @ 60" x 24" | AN4DSD156/W# | 2548 | 3139 |
| | | 4 @ 60" x 30" | AN4DSD1575/W# | 2778 | 3210 |
| | | 4 @ 72" x 24" | AN4DSD186/W# | 2803 | 3131 |
| | | 4 @ 72" x 30" | AN4DSD1875/W# | 3072 | 3608 |
|  | Desk Double sided 6 User Cable trays | 6 @ 48" x 24" | AN6DSD126/W# | 3118 | 3526 |
| | | 6 @ 48" x 30" | AN6DSD1275/W# | 3466 | 4012 |
| | | 6 @ 60" x 24" | AN6DSD156/W# | 3534 | 4068 |
| | | 6 @ 60" x 30" | AN6DSD1575/W# | 3925 | 4573 |
| | | 6 @ 72" x 24" | AN6DSD186/W# | 3950 | 4442 |
| | | 6 @ 72" x 30" | AN6DSD1875/W# | 4372 | 5176 |

*All shared desking shows pricing per pod.

Please note:

Cable tray covers can be found on page 103



- Select Worksurface Finish

Worksurface

| | | | |
|------------|-------------|-------------|-------------|
| 300 | 8232 | 7981 | 8201 |
| LPL | HPL | | |

Anvil Shared Desking

With standard screens

| Product | Description | Worktop | Code | LPL* | HPL* |
|---|---|---------------|----------------|------|------|
|  | Desk Double sided 2 User Cable trays Spine screens | 2 @ 48" x 24" | AN2DSD126/W## | 1468 | 1861 |
| | | 2 @ 48" x 30" | AN2DSD1275/W## | 1565 | 2048 |
| | | 2 @ 60" x 24" | AN2DSD156/W## | 1692 | 2141 |
| | | 2 @ 60" x 30" | AN2DSD1575/W## | 1812 | 2376 |
| | | 2 @ 72" x 24" | AN2DSD186/W## | 1882 | 2334 |
| | | 2 @ 72" x 30" | AN2DSD1875/W## | 2017 | 2643 |
|  | Desk Double sided 4 User Cable trays Spine screens | 4 @ 48" x 24" | AN4DSD126/W## | 3081 | 3353 |
| | | 4 @ 48" x 30" | AN4DSD1275/W## | 3325 | 3689 |
| | | 4 @ 60" x 24" | AN4DSD156/W## | 3557 | 3913 |
| | | 4 @ 60" x 30" | AN4DSD1575/W## | 3847 | 4279 |
| | | 4 @ 72" x 24" | AN4DSD186/W## | 4008 | 4336 |
| | | 4 @ 72" x 30" | AN4DSD1875/W## | 4277 | 4813 |
|  | Desk Double sided 6 User Cable trays Spine screens | 6 @ 48" x 24" | AN6DSD126/W## | 4391 | 4799 |
| | | 6 @ 48" x 30" | AN6DSD1275/W## | 4708 | 5254 |
| | | 6 @ 60" x 24" | AN6DSD156/W## | 5155 | 5689 |
| | | 6 @ 60" x 30" | AN6DSD1575/W## | 5099 | 5747 |
| | | 6 @ 72" x 24" | AN6DSD186/W## | 5770 | 6262 |
| | | 6 @ 72" x 30" | AN6DSD1875/W## | 6186 | 6990 |

*All shared desking shows pricing per pod.

Please note:

Comseal covers can be found on page 102

- Select finishes

Worksurface



300
8232
7981
8201
+
Screen insert

I
B
T

LPL
HPL
e-Panel
PVC

Anvil Shared Desking

With Devise screens

| Product | Description | Worktop | Code | LPL* | HPL* |
|---|---|---------------|----------------|------|------|
|  | Desk Double sided 2 User Cable trays Spine screens | 2 @ 48" x 24" | AN2DSD126/W## | 1940 | 2076 |
| | | 2 @ 48" x 30" | AN2DSD1275/W## | 2098 | 2280 |
| | | 2 @ 60" x 24" | AN2DSD156/W## | 2208 | 2386 |
| | | 2 @ 60" x 30" | AN2DSD1575/W## | 2429 | 2645 |
| | | 2 @ 72" x 24" | AN2DSD186/W## | 2441 | 2605 |
| | | 2 @ 72" x 30" | AN2DSD1875/W## | 2671 | 2939 |
|  | Desk Double sided 4 User Cable trays Spine screens | 4 @ 48" x 24" | AN4DSD126/W## | 3466 | 3738 |
| | | 4 @ 48" x 30" | AN4DSD1275/W## | 3740 | 4104 |
| | | 4 @ 60" x 24" | AN4DSD156/W## | 4001 | 4357 |
| | | 4 @ 60" x 30" | AN4DSD1575/W## | 4327 | 4759 |
| | | 4 @ 72" x 24" | AN4DSD186/W## | 4509 | 4837 |
| | | 4 @ 72" x 30" | AN4DSD1875/W## | 4811 | 5347 |
|  | Desk Double sided 6 User Cable trays Spine screens | 6 @ 48" x 24" | AN6DSD126/W## | 4940 | 5348 |
| | | 6 @ 48" x 30" | AN6DSD1275/W## | 5296 | 5842 |
| | | 6 @ 60" x 24" | AN6DSD156/W## | 5799 | 6333 |
| | | 6 @ 60" x 30" | AN6DSD1575/W## | 5735 | 6383 |
| | | 6 @ 72" x 24" | AN6DSD186/W## | 6490 | 6982 |
| | | 6 @ 72" x 30" | AN6DSD1875/W## | 6959 | 7763 |

*All shared desking shows pricing per pod.







Please note:
Eclipse tray covers can be found on page 87

- Select finishes

Worksurface
300
8232
7981
8201
 +
 E-Panel Color
DBL
DCH
DGR

LPL
HPL

Anvil 90° Workstations

| Product | Description | Worktop | Code | LPL* | HPL* |
|---|---|---------------------|----------------|-------|-------|
|  | 90° Workstation 2 User | 2 @ 72" x 72" x 24" | AN2U186186/W# | 1873 | 2173 |
| | | 2 @ 72" x 72" x 30" | AN2U187187/W# | 2110 | 2560 |
|  | 90° Workstation T layout 2 User Cable trays | 2 @ 72" x 72" x 24" | AN2T186186/W# | 2322 | 2622 |
| | | 2 @ 72" x 72" x 30" | AN2T187187/W# | 2596 | 3046 |
|  | 90° Workstation Plus layout 4 User Cable trays | 4 @ 72" x 72" x 24" | AN4P186186/W# | 4991 | 5591 |
| | | 4 @ 72" x 72" x 30" | AN4P187187/W# | 5548 | 6448 |
|  | 90° Workstation H layout 4 User Cable trays | 4 @ 72" x 72" x 24" | AN4H186186/W# | 4225 | 4825 |
| | | 4 @ 72" x 72" x 30" | AN4H187187/W# | 4691 | 5591 |
|  | 90° Workstation 6 User Cable trays | 6 @ 72" x 72" x 24" | AN6PT186186/W# | 6927 | 7827 |
| | | 6 @ 72" x 72" x 30" | AN6PT187187/W# | 7639 | 8989 |
|  | 90° Workstation Double plus layout 8 User Cable trays | 8 @ 72" x 72" x 24" | AN8P186186/W# | 9634 | 10834 |
| | | 8 @ 72" x 72" x 30" | AN8P187187/W# | 10599 | 12399 |

*All shared desking shows pricing per pod.

Please note:

Cable tray covers can be found on page 103

- Select Worksurface Finish

Worksurface

300

8232

7981





8201

LPL

HPL

Anvil 90° Workstations

With standard screens

| Product | Description | Worktop | Code | LPL* | HPL* |
|---|--|---------------------|-----------------|-------|-------|
|  | 90° Workstation T layout 2 User Spine screens Cable trays | 2 @ 72" x 72" x 24" | AN2T186186/W## | 2870 | 3170 |
| | | 2 @ 72" x 72" x 30" | AN2T187187/W## | 3207 | 3657 |
|  | 90° Workstation Plus layout 4 User Spine screens Cable trays | 4 @ 72" x 72" x 24" | AN4P186186/W## | 7280 | 7880 |
| | | 4 @ 72" x 72" x 30" | AN4P187187/W## | 7958 | 8858 |
|  | 90° Workstation H layout 4 User Spine screens Cable trays | 4 @ 72" x 72" x 24" | AN4H186186/W## | 5090 | 5690 |
| | | 4 @ 72" x 72" x 30" | AN4H187187/W## | 5552 | 6452 |
|  | 90° Workstation 6 User Spine screens Cable trays | 6 @ 72" x 72" x 24" | AN6PT186186/W## | 12355 | 13255 |
| | | 6 @ 72" x 72" x 30" | AN6PT187187/W## | 13110 | 14460 |
|  | 90° Workstation Double plus layout 8 User Spine screens Cable trays | 8 @ 72" x 72" x 24" | AN8P186186/W## | 14527 | 15727 |
| | | 8 @ 72" x 72" x 30" | AN8P187187/W## | 15443 | 17243 |

*All shared desking shows pricing per pod.

Please note:

Comseal covers can be found on page 102

- Select finishes

Worksurface
300
8232
7981
8201
+
Screen insert
I
B
T

LPL
HPL
e-Panel
PVC

Anvil 90° Workstations

With Devise screens

| Product | Description | Worktop | Code | LPL* | HPL* |
|---|---|---------------------|-----------------|--------------|--------------|
|  | 90° Workstation T layout 2 User Spine screens | 2 @ 72" x 72" x 24" | AN2T186186/W## | 3254 | 3554 |
| | Cable trays | 2 @ 72" x 72" x 30" | AN2T187187/W## | 3623 | 4073 |
|  | 90° Workstation Plus layout 4 User Spine screens | 4 @ 72" x 72" x 24" | AN4P186186/W## | 8241 | 8841 |
| | Cable trays | 4 @ 72" x 72" x 30" | AN4P187187/W## | 8982 | 9882 |
|  | 90° Workstation H layout 4 User Spine screens | 4 @ 72" x 72" x 24" | AN4H186186/W## | 5778 | 6378 |
| | Cable trays | 4 @ 72" x 72" x 30" | AN4H187187/W## | 6277 | 7177 |
|  | 90° Workstation 6 User Spine screens | 6 @ 72" x 72" x 24" | AN6PT186186/W## | 13976 | 14876 |
| | Cable trays | 6 @ 72" x 72" x 30" | AN6PT187187/W## | 14794 | 16144 |
|  | 90° Workstation Double plus layout 8 User Spine screens | 8 @ 72" x 72" x 24" | AN8P186186/W## | 16445 | 17645 |
| | Cable trays | 8 @ 72" x 72" x 30" | AN8P187187/W## | 17435 | 19235 |

*All shared desking shows pricing per pod.

Please note:

Eclipse tray covers can be found on page 87

- Select finishes

Worksurface
300
8232
7981
8201
 + **E-Panel Color**
DBL
DCH
DGR

LPL
HPL

Anvil 120° Workstations

| Product | Description | Worktop | Code | LPL* | HPL* |
|---|---|----------------------|----------------|-------|-------|
|  | 120° Workstation 3 User Cable trays | 3 @ 48" x 48" x 24" | AN3SW12126/W# | 3754 | 4594 |
|  | 120° Workstation 6 User Cable trays | 6 @ 48" x 48" x 24" | AN6SW12126/W# | 7508 | 9188 |
|  | 120° Workstation 9 User Cable trays | 9 @ 48" x 48" x 24" | AN9SW12126/W# | 11262 | 13782 |
|  | 120° Workstation 12 User Cable trays | 12 @ 48" x 48" x 24" | AN12SW12126/W# | 15016 | 18376 |
|  | 120° Workstation 18 User Cable trays | 18 @ 48" x 48" x 24" | AN18SW12126/W# | 22524 | 27564 |

*All shared desking shows pricing per pod.

Please note:

Cable tray covers can be found on page 103





- Select Worksurface Finish

Worksurface 300 8232 7981 8201

LPL HPL

Anvil 120° Workstations

With standard screens

| Product | Description | Worktop | Code | LPL* | HPL* |
|---|--|----------------------|-----------------|--------------|--------------|
|  | 120° Workstation 3 User Cable trays Comseal covers Spine screens | 3 @ 48" x 48" x 24" | AN3SW12126/W## | 4642 | 5482 |
|  | 120° Workstation 6 User Cable trays Comseal covers Spine screens | 6 @ 48" x 48" x 24" | AN6SW12126/W## | 9284 | 10964 |
|  | 120° Workstation 9 User Cable trays Comseal covers Spine screens | 9 @ 48" x 48" x 24" | AN9SW12126/W## | 13926 | 16446 |
|  | 120° Workstation 12 User Cable trays Comseal covers Spine screens | 12 @ 48" x 48" x 24" | AN12SW12126/W## | 18568 | 21928 |
|  | 120° Workstation 18 User Cable trays Comseal covers Spine screens | 18 @ 48" x 48" x 24" | AN18SW12126/W## | 27852 | 32892 |

*All shared desking shows pricing per pod.

Please note:

Comseal covers can be found on page 102

- Select finishes

Workspace
300
8232
7981
8201
+
Screen insert
I
B
T

LPL
HPL
e-Panel
PVC

Anvil 120° Workstations

With Devise screens

| Product | Description | Worktop | Code | LPL* | HPL* |
|---|--|----------------------|-----------------|-------|-------|
|  | 120° Workstation 3 User Cable trays Spine screens | 3 @ 48" x 48" x 24" | AN3SW12126/W## | 5222 | 6062 |
|  | 120° Workstation 6 User Cable trays Spine screens | 6 @ 48" x 48" x 24" | AN6SW12126/W## | 10445 | 12125 |
|  | 120° Workstation 9 User Cable trays Spine screens | 9 @ 48" x 48" x 24" | AN9SW12126/W## | 15666 | 18186 |
|  | 120° Workstation 12 User Cable trays Spine screens | 12 @ 48" x 48" x 24" | AN12SW12126/W## | 20889 | 24249 |
|  | 120° Workstation 18 User Cable trays Spine screens | 18 @ 48" x 48" x 24" | AN18SW12126/W## | 31333 | 36373 |

*All shared desking shows pricing per pod.

Please note:

Eclipse tray covers can be found on page 87

- Select finishes

Worksurface 300 8232 7981 8201 + **E-Panel Color** DBL DCH DGR

LPL HPL

Standard Desk Hung Screens

| Product | Description | Dimensions | Code | USD |
|---|---------------------------|----------------|-------------|-----|
|  | Offset* desk hung screen | 48" x 36" high | AXHS12OFF/# | 505 |
| | | 60" x 36" high | AXHS15OFF/# | 657 |
| | | 72" x 36" high | AXHS18OFF/# | 696 |
| | Standard desk hung screen | 48" x 36" high | AXHS12/# | 475 |
| | | 60" x 36" high | AXHS15/# | 626 |
| | | 72" x 36" high | AXHS18/# | 665 |

Please note:

Offset Bracket code (OFF) is for screens used on single sided Anvil Straightline workstations.

- Select screen insert

E-panel



OR

Translucent

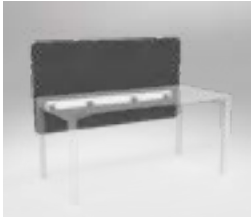

Devise Desk Hung Screens

| Product | Description | Dimensions | Code | USD |
|---|------------------|----------------|------------|-----|
|  | Desk hung screen | 48" x 36" high | DHS48OFF/# | 688 |
| | | 60" x 36" high | DHS60OFF/# | 555 |
| | | 72" x 36" high | DHS72OFF/# | 765 |
| | | 48" x 36" high | DHS48/# | 522 |
| | | 60" x 36" high | DHS60/# | 731 |
| | | 72" x 36" high | DHS72/# | 722 |

Please note:

Offset Bracket code (OFF) is for screens used on single sided Anvil Straightline workstations.

- Select Screen Colour



E-panel



Standard Return Screens

| Product | Description | Dimensions | Code | USD |
|--|--|----------------|------------|-----|
|  | Return Screen Single sided desks | 23" x 20" high | AXSRS58/# | 168 |
| | | 29" x 20" high | AXSRS73/# | 196 |
|  | Return Screen Double sided desks | 26" x 20" high | AXRS65/# | 165 |
| | | 32" x 20" high | AXRS80/# | 194 |
|  | Return Screen Double sided desks end of run | 26" x 20" high | AXRS65/#_E | 181 |
| | | 32" x 20" high | AXRS80/#_E | 213 |

Devise Return Screens

| Product | Description | Dimensions | Code | USD |
|---|--|----------------|-----------|-----|
|  | Return screen Single and double sided desks | 23" x 12" high | DRS5931/# | 159 |
| | | 29" x 12" high | DRS7431/# | 187 |
|  | Return screen Single and double sided desks | 23" x 18" high | DRS5946/# | 193 |
| | | 29" x 18" high | DRS7446/# | 225 |

- Select Standard screen insert

E-panel



OR

Translucent







- Select Devise Screen Colour

E-panel



Anvil Electrical

| Product | Description | Dimensions | Code | USD |
|---|---|-----------------|------------------|-----|
|  | Voltra - White 3 outlets, 1 USB-A, 1 USB-C 108" cord | | AXPM301U1C-W-108 | 232 |
| | Voltra - Black 3 outlets, 1 USB-A, 1 USB-C 108" cord | | AXPM301U1C-B-108 | 232 |
|  | One Duplex For one duplex in tray | | ELECTRICAL_1 | 188 |
|  | Two Duplex For two duplexes in tray | | ELECTRICAL_2 | 343 |
|  | Base Infeed Hardwire | Standard - 72" | EHINFD-72 | 207 |
| | | NYC - 72" | EHNYCINFD-72 | 207 |
| | Ceiling Infeed Hardwire | Standard - 144" | EHINFD-144 | 249 |
| | | NYC - 144" | EHNYCINFD-144 | 249 |

Accessories

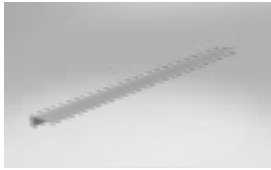
| Product | Description | Dimensions | Code | USD |
|---|---|------------|--------|-----|
|  | Eclipse Tray Tidy Flexible PVC tray cover | 48" | ECTT48 | 74 |
| | | 60" | ECTT60 | 94 |
| | | 72" | ECTT72 | 111 |

Please note:

- All electrical prices include all required jumper cables, connecting hardware, duplexes, electrical face plate, and data face plate with four knockouts
- Single-sided desks can only have below desk electrical, and double sided desks can only have above desk electrical.





Receptions & Storage

| | |
|--------------------------|----|
| Reception Counters | 92 |
| Mobiles | 93 |
| Caddy Mobiles | 94 |
| Storage Towers | 95 |
| Overhead Storage | 95 |
| Storage | 96 |
| Worktops | 97 |

Reception Counters

| Product | Description | Dimensions | Code | USD |
|---|--|--|--------------|------|
|  | Axis reception Pop-top Fits over desk - AXSD1875/# - AX9W181875/# | 72.5" wide x 42" high x 12" deep | AXRPD183/W | 875 |
|  | Axis reception corner Pop-top Fits over workstation - AX9W181875/# | 72.5" x 75" x 42" high x 12" deep <i>Can be left hand or right hand</i> | AXRPW18183/W | 1616 |
|  | Axis reception Fits over desk - AXSD1875/# - AX9W181875/# | 72.5" wide x 38.5" high x 12" deep | AXRD183/W | 625 |
|  | Axis reception corner Fits over workstation - AX9W181875/# | 72.5" x 75" x 38.5" high x 12" deep <i>Can be left hand or right hand</i> | AXRW18183/W | 1144 |
|  | Anvil reception - White Fits over desk - AXSD1875/# | 73"-96" wide x 37" deep x 42" high | ANRC/WW | 2056 |
| | Anvil reception - Silver Fits over desk - AXSD1875/# | 73"-96" wide x 37" deep x 42" high | ANRC/WS | 2056 |
| | Anvil Facade Upgrade | 38.5" wide x 15" deep x 42" high | ANRFD/# | 656 |

Please note:

Reception units require the desk to be ordered separately.

- Select Facade Upgrade Finish

Worksurface







8232

7981

8201

HPL

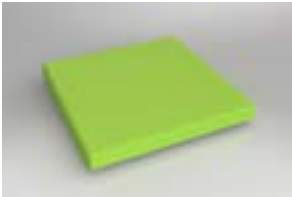
Mobiles







| Product | Description | Dimensions | Code | USD |
|---|---|--|----------------|-----|
|  | Mobile BBF - White Two box drawers One file drawer Gang locking | 25.2"H x 16.0"W x 18.6"D | AXM2F/W | 614 |
|  | Mobile BBF - Black Two box drawers One file drawer Gang locking | 25.2"H x 16.0"W x 18.6"D | AXM2F/B | 614 |
|  | Mobile BF - White One box drawer One file drawer Gang locking | 20.5"H x 12.0"W x 18.6"D | AXM1F/W | 481 |
|  | Mobile BF - Black One box drawer One file drawer Gang locking | 20.5"H x 12.0"W x 18.6"D | AXM1F/B | 481 |
|  | Toppa pad - large Breathe Upholstery | 1.0"H x 16.0"W x 18.6"D <i>Does not fit BF mobile pedestal</i> | AXMTOPPA/# | 70 |
|  | Toppa pad - small Breathe Upholstery | 1.0"H x 12.0"W x 18.6"D <i>Does not fit BBF mobile pedestal</i> | AXBFTOPPA-US/# | 70 |

- Select fabric - Toppa pad

Breathe



Caddy Mobiles



| Product | Description | Dimensions | Code | USD |
|---|--|---|------------|------|
|  | Bookcases | 25.2"H x 34.5"W x 18.1"D | AXCMB/W | 492 |
|  | Bookcase & drawer | 25.2"H x 34.5"W x 18.1"D <i>Can be left hand or right hand</i> | AXCM1/W | 1027 |
|  | Drawers | 25.2"H x 34.5"W x 18.1"D | AXCM2/W | 1560 |
|  | Bookcase & tambour | 25.2"H x 34.5"W x 18.1"D <i>Can be left hand or right hand</i> | AXCMT1/W | 948 |
|  | Drawer & tambour | 25.2"H x 34.5"W x 18.1"D <i>Can be left hand or right hand</i> | AXCMTD/W | 1481 |
|  | Tambours | 25.2"H x 34.5"W x 18.1"D | AXCMT2/W | 1404 |
|  | Toppa pad Breathe Upholstery | 1.0"H x 16.0"W x 18.6"D | AXMTOPPA/# | 70 |

- Select fabric - Toppa pad

Breathe









Storage Towers

| Product | Description | Dimensions | Code | USD |
|--|---|--------------------------|------------|------|
|  | Bookcase Adjustable shelves | 49.2"H x 17.7"W x 18.5"D | AXBST12/W | 518 |
|  | Bookcase & drawers Adjustable shelves | 49.2"H x 17.7"W x 18.5"D | AXBSTD12/W | 1052 |
|  | Bookcase & tambour Adjustable shelves | 49.2"H x 17.7"W x 18.5"D | AXBSTT12/W | 972 |









Overhead Storage

| Product | Description | Dimensions | Code | USD |
|---|--|--------------------------|-------------|-----|
|  | Wall-mount hutch 4 locking doors | 47.25" W x 16.9"H x 14"D | AX12WMH4D/W | 812 |

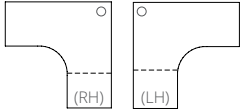
Storage

| Product | Description | Dimensions | Code | USD |
|---|--|--------------------------|----------|------|
|  | Bookcase 3 Level | 49.2"H x 35.4"W x 11.8"D | AXB12/W | 617 |
|  | Cupboard 3 Level Locking | 49.2"H x 35.4"W x 15.7"D | AXC12/W | 836 |
|  | Credenza 2 Level Locking | 35.4"H x 70.9"W x 15.7"D | AXCZ18/W | 1175 |
|  | Lateral file 2 drawer Locking | 28.7"H x 35.4"W x 23.6"D | AXLF2/W | 1229 |
|  | Tambour 3 Level Locking | 41.3"H x 35.4"W x 17.7"D | AXT12/W | 1153 |
|  | Upgrade Tambour planter box <i>Plants not included</i> | 7.9"H x 35.4"W x 17.7"D | AXPBOX/W | 167 |
|  | Desk mount shelf 4 x chrome hoops | 9.6"H x 23.6"W x 11.8"D | AXDSH6/W | 169 |

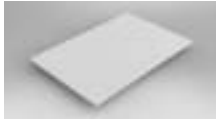
Worktops

| Product | Description | Dimensions | Code | LPL | HPL |
|---|--|---------------------------------|-----------------|-----|-----|
|  | Desk | 36" x 24" | AXSD096/#_T | 117 | 159 |
| | | 48" x 24" | AXSD126/#_T | 166 | 234 |
| | | 48" x 30" | AXSD1275/#_T | 199 | 290 |
| | | 60" x 24" | AXSD156/#_T | 202 | 291 |
| | | 60" x 30" | AXSD1575/#_T | 249 | 357 |
| | | 72" x 24" | AXSD186/#_T | 241 | 323 |
| | | 72" x 30" | AXSD1875/#_T | 292 | 426 |
| | | 72" x 36" | AXSD189/#_T | 295 | 464 |
|  | 90° Workstation  | 72" x 72"/24" (Right Hand Join) | AX9W18186/WR_T | 509 | |
| | | 72" x 72"/24" (Left Hand Join) | AX9W18186/WL_T | 509 | |
| | | 72" x 72"/30" (Right Hand Join) | AX9W181875/WR_T | 547 | |
| | | 72" x 72"/30" (Left Hand Join) | AX9W181875/WL_T | 547 | |
|  | 120° Workstation | 48" x 48"/24" | AX12W12126/#_T | 513 | 793 |
|    | Meeting table | 36" diameter | AXT900R/#_T | 174 | 235 |
| | | 42" diameter | AXT105R/#_T | 229 | 338 |
| | | 60" diameter | AXT150R/#_T | 489 | 659 |
| | | 24" x 24" | AXSD066/#_T | 90 | 107 |
| | | 39" x 39" | AXT1010/#_T | 213 | 371 |
| | | 60" x 48" | AXT1512/#_T | 405 | 594 |
| | | 72" x 48" | AXT1812/#_T | 423 | 623 |
| | | 95" x 48" | AXT2412/#_T | 528 | 843 |
|  | Meeting table With cutout for power modules | 72" x 48" | AXT1812/#_T-1C | 423 | 623 |
| | | 96" x 48" | AXT2412/#_T-1C | 528 | 843 |

- Select Worksurface Finish

Worksurface

300 8232 7981 8201



LPL HPL





Mobile Dividers

Orbit Divider

| Product | Description | Dimensions | Code | USD |
|---|--|------------|----------------|-------------|
|  | Mobile Divider Whiteboard Locking casters | 60" x 36" | ODM6036/WB | 997 |
|  | Mobile Divider Pixel design Locking casters | 60" x 36" | ODMPXL6036/GYW | 1608 |

THIS PAGE IS INTENTIONALLY
LEFT BLANK









Accessories & Components

| | |
|-------------------------------|-----|
| Cable Management..... | 104 |
| Cable Tray Covers..... | 105 |
| Accessories & Components..... | 106 |
| Monitor Arms..... | 107 |
| Viro Planter Wall..... | 107 |

Cable Management

| Product | Description | Dimensions | Code | USD |
|---|---|---------------------------|-------------|-----|
|  | Single-sided cable tray Power/data segregation Side fixing to Axis/Anvil horizontal support rail | 42.5" Length | AXCTS11/# | 114 |
| | | 54.3" Length | AXCTS14/# | 150 |
| | | 66.1" Length | AXCTS17/# | 179 |
|  | Single-sided cable tray Power/data segregation Top Lip Fixing | 42.5" Length | AXCTT11/# | 114 |
| | | 54.3" Length | AXCTT14/# | 150 |
| | | 66.1" Length | AXCTT17/# | 179 |
|  | Cable Cobra White Power/data segregation | 42.5" Length | CABCOBRA/@ | 88 |
|  | Cable Clutch White Power/data segregation | Set of 5 | CABCLUTCH_W | 43 |
|  | Comseal cable tidy brushes | 46.5" for 48" workstation | ANCS12/B | 66 |
| | | 58.5" for 60" workstation | ANCS15/B | 83 |
| | | 70.3" for 72" workstation | ANCS18/B | 99 |

- Select finish



@ - Select finish



Cable Tray Covers

| Product | Description | Dimensions | Code | LPL* | HPL* |
|---|-------------------|-------------------------------|-------------|------|------|
|  | Cable tray covers | Fits 48" Desk with Twin Power | AXT450125/# | 182 | 214 |
| | | Fits 60" Desk with Twin Power | AXT600125/# | 188 | 230 |
| | | Fits 72" Desk with Twin Power | AXT750125/# | 198 | 244 |
| | | Fits 48" Desk with Quad Power | AXT407125/# | 182 | 216 |
| | | Fits 60" Desk with Quad Power | AXT557125/# | 188 | 222 |
| | | Fits 72" Desk with Quad Power | AXT707125/# | 198 | 242 |

*Pricing is shown per pair.

Please note:





All cable tray covers include necessary hardware.

- Select Worksurface Finish



Worksurface 300 8232 7981 8201

LPL HPL



Accessories & Components

| Product | Description | Dimensions | Code | USD |
|---|---|---|---------------|-----|
|  | Paper tray Rail hung White | | AXA4TRAY/W | 39 |
|  | Pen holder Rail hung White | | AXPENTRAY/W | 20 |
|  | Deskmount shelf brackets | | AXDSHB/W | 41 |
|  | E-panel screen brackets | A For double sided desk | ESCRCLAMPDS/W | 49 |
| | | B For single sided desk | ESCRCLAMPT/W | 40 |
| | | C For single sided desk | ESCRCLAMPSS/W | 47 |
|  | Keys and locks | Axis system master key | AXKEY | 8 |
| | | Axis system master key for barrel removal | AXKEYB | 9 |
| | | Axis system keyed alike barrel and key | AXBARRELM | 9 |
| | | | AXBARRELC | 18 |

Monitor Arms

| Product | Description | Dimensions | Code | USD |
|--|---|-------------------------------|---------|-----|
|  | Fulcrum Dual Gas spring arms Grab Handle Black | Accommodates 17" - 32" screen | FCDMA/B | 465 |
|  | Fulcrum Single Gas spring arms Desk mount Black | Accommodates 17" - 49" screen | FCSMA/B | 300 |
|  | Single monitor arm Desk mount Black | Accommodates 13" - 27" screen | FWMA1/B | 218 |

Planter Wall

| Product | Description | Dimensions | Code | USD |
|---|--------------------------------|----------------|--------------|------|
|  | Viro Wall Frame only | 78" x 40" x 8" | PLANTER/B | 2148 |
|  | Pots | | PLANTERPOT/B | 32 |



General - 10 Year

Axis desking, side & conference tables, receptions, storage; Anvil desking, receptions, storage; Agile desking; Modulus training & conference tables; Uni training tables

All Workspace48 products are durable for long-term performance and value. Our products have been rigorously tested to the equivalent of 10 years average use, and our processes comply with internationally recognized certifications. We know the peace of mind a warranty like this can give when making a purchase. If you need to know any information about the legal terms of your warranty, you can find everything right here, or simply give one of our friendly account managers a call.

The 10 Year Warranty is valid on orders placed on or after January 1, 2020.

Warranty

Workspace48 promises the original purchaser that it will repair or replace with the comparable product, at its option and free of charge (for material and components) any product, part or component which fails under normal use over the duration of specified warranty term (taken from the date of purchase).

Normal commercial usage is defined as the equivalent of a single shift, 40-hour work week.

A Customer who requests services under this warranty must comply with directions from Workspace48 staff if the warranty claim is to be investigated, and if Workspace48 is to provide repairs and/or spare parts and/or replacement solutions (where applicable). The Customer will usually be required to provide a detailed description of the warranty service they are requesting, accompanied by any relevant photos or videos.

If the Customer does not comply with the directions aforementioned, Workspace48 is not required to provide services in accordance with this warranty. Without the description and images, Workspace48 can neither investigate the claim nor provide an appropriate solution.

Goods purchased from Workspace48 are covered by guarantees that cannot be excluded under Canadian Consumer Law. The Customer is entitled to a replacement or refund in a case of major fault.

Minor variations in dimensions, color, grain, or finish in Goods received by a Customer, when compared with images or descriptions on the Website, are not covered by this Warranty. The Warranty does not cover damage that affects only packaging.

Warranty Limitations

The particular product lines, materials and components listed below are covered according to the following schedule from the date of sale:

- Five Years - Electric motors, workstation electrical components

Warranty Exclusions

This warranty does not apply, and no other warranty applies to:

- Products that were not installed, used, or maintained in accordance with Workspace48 instructions
- Products that have been disassembled, modified, or rebuilt
- Normal wear and tear, which is to be expected over the course of ownership
- High-wear items such as glides and textiles
- Abuse, misuse, or accident
- Alteration or modification of the product including substitution of Workspace48 components with any unauthorized non-Workspace48 components
- Products considered consumables, Customer's Own Material (COM) or non-standard textiles and materials
- Variations occurring in surface materials (e.g., color-fastness or matching grains, textures, and colors across dissimilar lots)
- Products used for rental purposes

To the extent allowed by law, Workspace48 makes no other warranty, either express or implied, including any warranty of merchantability or fitness for a particular purpose. Workspace48 will not be liable for any consequential or incidental damages.



Seating - 10 Year

Adapta, Balance Executive, Balance Task, Balance Guest, Balance Training, Game, Metro, Mode, Otto, Politan

All Workspace48 products are durable for long-term performance and value. Our products have been rigorously tested to the equivalent of 10 years average use, and our processes comply with internationally recognized certifications. We know the peace of mind a warranty like this can give when making a purchase. If you need to know any information about the legal terms of your warranty, you can find everything right here, or simply give one of our friendly account managers a call.

The 10 Year Warranty is valid on orders placed on or after January 1, 2020.

Warranty

Workspace48 promises the original purchaser that it will repair or replace with the comparable product, at its option and free of charge (for material and components) any product, part or component which fails under normal use over the duration of specified warranty term (taken from the date of purchase).

Normal commercial usage is defined as the equivalent of a single shift, 40-hour work week.

A Customer who requests services under this warranty must comply with directions from Workspace48 staff if the warranty claim is to be investigated, and if Workspace48 is to provide repairs and/or spare parts and/or replacement solutions (where applicable). The Customer will usually be required to provide a detailed description of the warranty service they are requesting, accompanied by any relevant photos or videos.

If the Customer does not comply with the directions aforementioned, Workspace48 is not required to provide services in accordance with this warranty. Without the description and images, Workspace48 can neither investigate the claim nor provide an appropriate solution.

Goods purchased from Workspace48 are covered by guarantees that cannot be excluded under Canadian Consumer Law. The Customer is entitled to a replacement or refund in a case of major fault.

Minor variations in dimensions, color, grain, or finish in Goods received by a Customer, when compared with images or descriptions on the Website, are not covered by this Warranty. The Warranty does not cover damage that affects only packaging.

Warranty Limitations

The particular product lines, materials and components listed below are covered according to the following schedule from the date of sale:

- Five Years - Link and Luna chairs

Warranty Exclusions

This warranty does not apply, and no other warranty applies to:

- Products that were not installed, used, or maintained in accordance with Workspace48 instructions
- Products that have been disassembled, modified, or rebuilt
- Normal wear and tear, which is to be expected over the course of ownership
- High-wear items such as glides and textiles
- Abuse, misuse, or accident
- Alteration or modification of the product including substitution of Workspace48 components with any unauthorized non-Workspace48 components
- Products considered consumables, Customer's Own Material (COM) or non-standard textiles and materials
- Variations occurring in surface materials (e.g., color-fastness or matching grains, textures, and colors across dissimilar lots)
- Products used for rental purposes

To the extent allowed by law, Workspace48 makes no other warranty, either express or implied, including any warranty of merchantability or fitness for a particular purpose. Workspace48 will not be liable for any consequential or incidental damages.

Dealer Freight Schedule

| ZONE 1 - Transit time: 1-3 days | ZONE 2 - Transit time: 2-3 days | ZONE 3 - Transit time: 3-5 days | ZONE 4 - Transit time: 3-6 days |
|--|--|--|--|
| <i>** Pricing tiers below shown in NET pricing</i> | | | |
| Minimum - \$145 | Minimum - \$165 | Minimum - \$185 | Minimum - \$205 |
| 0\$ - \$5,000: 12% of NET | 0\$ - \$5,000: 13% of NET | 0\$ - \$5,000: 14% of NET | 0\$ - \$5,000: 15% of NET |
| \$5,000 - \$10,000: 9% of NET | \$5,000 - \$10,000: 10% of NET | \$5,000 - \$10,000: 11% of NET | \$5,000 - \$10,000: 12% of NET |
| \$10,000 - \$30,000: 6% of NET | \$10,000 - \$30,000: 7% of NET | \$10,000 - \$30,000: 7% of NET | \$10,000 - \$30,000: 8% of NET |
| \$30,000 - \$100,000: 5% of NET | \$30,000 - \$100,000: 6% of NET | \$30,000 - \$100,000: 6% of NET | \$30,000 - \$100,000: 6% of NET |
| \$100,000+: 2% of NET | \$100,000+: 2% of NET | \$100,000+: 2% of NET | \$100,000+: 2% of NET |

| | | | | | | |
|----------------------|---------------|-------------|----------------|------------|---------|--------------|
| Connecticut | New York | Alabama | New Hampshire | Arizona | Utah | California |
| Delaware | Ohio | Georgia | North Carolina | Arkansas | Wyoming | Nevada |
| Illinois | Pennsylvania | Iowa | South Carolina | Colorado | | Oregon |
| Indiana | Rhode Island | Kansas | | Florida | | Washington |
| Kentucky | Tennessee | Maine | | Idaho | | Montana |
| Maryland | Vermont | Minnesota | | Louisiana | | North Dakota |
| Massachusetts | Virginia | Mississippi | | New Mexico | | South Dakota |
| Michigan | West Virginia | Missouri | | Oklahoma | | |
| New Jersey | Wisconsin | Nebraska | | Texas | | |
| District Of Columbia | | | | | | |

- Price ranges are shown as NET prices
- Modulus conference tables may have an additional \$100 freight charge. Please request freight quote per order
- Freight structures are based only on stock draw projects; container projects are quoted separately
- Freight schedules are subject to change every six months
- Freight rates are applicable to carriers and transit times selected by WORKSPACE48. Special requests may result in additional charges
- Freight rates are to metropolitan areas; shipments to all other areas may had additional charges
- Freight rates are per shipment, not per order. If two shipments are required, two freight charges will be applied.
- Workspace48 does not arrange shipping to the USA for orders sold through Canadian dealers.

Terms & Conditions

1. These terms and conditions shall apply to all sales of goods by Workspace48 Inc. No variation of any of these conditions shall be binding unless expressly agreed to by Workspace48 Inc. in writing.
2. All prices are exclusive of GST/HST unless otherwise stated.
3. All orders under \$3,000 net will be subject to a \$33 NET packaging fee.
4. Payment in full shall be made to Workspace48 Inc. net 30 days on invoice. All orders over \$50,000 require a 35% deposit. Container payment terms are 30% deposit with order, 70% upon arrival of product. Workspace48 Inc. reserves the right to demand payment before that date or in advance and further reserves the right to specify in any quotation a requirement for a deposit to be paid before work shall commence. Interest shall be payable to Workspace48 Inc. on the Customer's overdue accounts at the rate of 18% per annum calculated on a daily basis to run from the due date for payment until receipt by Workspace48 Inc. of the full amount payable. The Customer shall pay all costs including any legal costs incurred in recovering overdue accounts.
5. We may suspend or terminate this agreement if at any time we consider the Customer's credit worthiness to be unsatisfactory for any reason or if the Customer is in default of any of its payment or other obligations hereunder. We shall not be responsible under any circumstances for any loss, damages, costs or expenses whatsoever caused in any way by the suspension or termination under this clause.
6. Goods returned for credit will only be accepted subject to Workspace48 Inc.'s prior agreement in writing with all freight charges prepaid by the Customer. Returned goods, if accepted by Workspace48 Inc., are subject to a minimum restocking fee of the greater of \$75 or 20% of the invoice price. Returned product will not be accepted if it has been removed from its original packaging and no credit will be issued for product returned damaged.
7. Prices are subject to variation without notice, and goods and services will be invoiced at prices current at the time of their provision unless otherwise agreed in writing.
8. Sales tax and any other taxes or duty on or in respect of the goods sold by Workspace48 Inc. imposed by any Provincial or Federal Government law shall be payable by the Customer, but if those taxes or duties by law are or become payable by Workspace48 Inc., the prices in respect of the goods shall be increased by the amount necessary to ensure that the net amount actually received by Workspace48 Inc. is as if those taxes or duties were not payable.

9. If the Customer is a limited liability company or a trust, then the director(s) and shareholder(s) of the company or the trustee(s) of the trust (as the case requires), hereby guarantee the performance of the Customer's obligations under this agreement and are personally liable to meet the Customer's obligations under this agreement in the event of the Customer's default. Those director(s) and shareholder(s) or trustee(s) also agree to indemnify Workspace48 Inc. and hold Workspace48 Inc. harmless for any losses Workspace48 Inc. sustains as a result of the Customer's act or omission. A director, shareholder or trustee (as the case requires) must reimburse Workspace48 Inc. for all its losses caused by the Customer's act or omission within 21 days of Workspace Inc. making a demand for such reimbursement (time being of the essence). Any director, shareholder or trustee signing this agreement on behalf of the Customer also signs in a personal capacity for the purposes of the guarantee and indemnity contained in this clause.
10. The Customer warrants that such plans, specifications, measurements or information that have been supplied by the Customer at the time of commencing work on purpose built furniture are correct and can be relied upon. Once work has started the Customer may not vary or withdraw from this or any other agreement with Workspace48 Inc. unless with Workspace48 Inc.'s agreement in writing.
11. All warranties conditions and representations whether express or implied other than any express warranty stated by Workspace48 Inc. in writing are hereby expressly negated and excluded except in circumstances where Workspace48 Inc. is by law unable to exclude or limit its liability. Provided that where the Customer is a consumer for the purpose of the Trade Practices Act, but the goods or services are not of a kind ordinarily required for personal domestic or household use or consumption, the liability of Workspace48 Inc. shall be limited as determined by Workspace48 Inc. to anyone or more of the following:
 - a. The replacement of the goods or the supply of equivalent goods
 - b. The payment of the costs of replacing the goods or of acquiring equivalent goods
12. No claim of any nature whatsoever (other than relating to warranty) will be recognised unless made within 24 hours of delivery. All freight costs involved in returning goods must be paid by the Customer. A copy of the invoice evidencing sale to the Customer is to be included with the goods, and include photo's to clearly identify the issue concerned.
13. Subject to everything in these conditions Workspace48 Inc. makes no further condition, warranty or representation, whether express or implied, written or oral in respect of the goods or services.
14. Notwithstanding anything above Workspace48 Inc. shall not be liable for any consequential or indirect losses expenses or damages suffered by the Customer in consequence of any defect in materials or workmanship of the goods.
15. Claims for errors, short supply, or for goods arriving in a damaged condition shall be made within seven (7) days of the date of invoice, and the Customer shall refuse to sign any deliver docket where goods arrive in a damaged condition. Workspace48 Inc. must be notified of the claim within 24 hours and assigned a file number by Workspace48 Inc. or the claim will not be accepted. The Customer is deemed to have accepted the goods unless it makes a claim under this clause. The Customer acknowledges that a signed delivery docket signifies acceptance that the goods arrived in an undamaged state and Workspace48 Inc. shall not be liable to repair any damage in such cases. The Customer is responsible to file any claim resulting from Customers' carrier.
16. Risk in goods supplied under this agreement passes to the Customer upon delivery to the Customer or its agent or upon possession of the goods by the Customer or its agent, whichever is the earlier.
17. Workspace48 Inc. shall not be liable in any way whatsoever for any failure to deliver any order on time or for non-delivery or delay caused directly or indirectly by war, act of God, strike, lockout, riot, Government action or interference, fire, earthquake, material, shortage, late delivery by manufacturers, shipping or transport delay or any other cause beyond the reasonable control of Workspace48 Inc. The Customer shall be bound to accept and pay for goods delivered within a reasonable time after such cause for the failure or delay on the part of Workspace48 Inc. has ceased to operate.
18. To the fullest extent possible, ownership of any goods supplied by Workspace48 Inc. is retained by Workspace48 Inc. until payment in full is made for the goods supplied and for all other goods supplied by Workspace48 Inc. to the Customer. This clause creates a security interest under the Personal Property Securities Act 2009 in favour of Workspace48 Inc. in all present and after-acquired property supplied by Workspace48 Inc. to the Customer. Customers waive the right to be notified in writing of registration on the Personal Property Securities Register.
19. Workspace48 Inc., its servants or its agents may immediately without giving the Customer any notice or waiting any time, retake possession of the goods supplied or any other goods supplied by Workspace48 Inc. under any other arrangement under which title in those goods is still maintained by Workspace48 Inc.
20. The Customer gives Workspace48 Inc. authority for its servants and agents to enter and remain upon any land or premises where in Workspace48 Inc.'s opinion Workspace48 Inc.'s goods may be stored and take possession of the said goods.
21. Under no circumstances shall Workspace48 Inc. be liable for any damage, costs, losses or expenses arising on or resulting from such repossession.
22. The Customer shall hold the proceeds of sales of our goods arising in the normal course of trade, upon trust for Workspace48 Inc. and shall promptly account to Workspace48 Inc. for such proceeds or the amount of them necessary to pay all amounts due to Workspace48 Inc.
23. The failure on the part of Workspace48 Inc. to exercise and enforce any rights conferred by this agreement shall not be deemed to be a waiver of any such right nor operate so as to bar the exercise or enforcement thereof at any time or times thereafter.
24. All freight charges are as described in your company specific discount structure, unless otherwise specified on a project specific quotation.
25. Upon receipt of an approved credit application, orders can be placed in the following way; Phone: 416 441 9898; Email: Orders@workspace48.com. Phone orders are required to have final confirmation in writing. All orders will be acknowledged by email as final confirmation of your order, including net pricing and quantities. If in the unlikely event of low stock, you will be notified and alternative solutions advised.
26. In-stock items can be cancelled by the Customer in writing prior to dispatch, without any cancellation charge. Orders cancelled after shipping and before arrival to the Customer will be subject to a minimum handling fee of \$75 plus any applicable direct costs, payable by the Customer. Any custom built products are not able to be cancelled once the order has been acknowledged and entered into production.

Our Vision

**REVOLUTIONIZING THE WAY OFFICE
FURNITURE IS BOUGHT AND SOLD.**



E info@workspace48.com | P 416 441 9898