

WORKSPACE

USA PRICEBOOK | 2023



THE FUTURE OF OFFICE FURNITURE IS HERE.

Workspace48 has some of the best and brightest minds in the office furniture industry Galaxy! We understand the changing office landscape and have an out of this world catalogue of product knowledge to provide the best solutions for any office fit-out project.

It is our mission is to change & revolutionise the office furniture world around one fundamental concept... Everything in this catalogue and in-stock will ship within 48 hours!

Contents

Seating	5
Tables	17
Desking	41
Receptions & Storage	91
Mobile Dividers.....	99
Accessories & Components.....	103
Product Warranty	108
Freight	110
Terms & Conditions.....	111









Seating

Essence & Compass Task	6
Balance Executive	8
Balance Seating	9
Mode	10
Adapta	11
Luna	12
Game	13
Link	14
Politan	15
Otto	15

Essence Task

Product	Description	Code	USD
	Essence Black frame Nova fabric seat Adjustable arms	ESS/BCB	617
	Essence White frame Nova Grey fabric seat Adjustable arms	ESS/GGW	675

Compass Task







Product	Description	Code	USD
	Compass Black frame Nova fabric seat Adjustable arms Adjustable lumbar	COML/BCB	833
	Compass White frame Nova Grey fabric seat Adjustable arms Adjustable lumbar	COML/GGW	883

Please note:

All Essence and Compass seating come standard with hardfloor casters.

THIS PAGE IS INTENTIONALLY
LEFT BLANK

Balance Executive





Product	Description	Code	USD
	Black faux leather seat Polished alloy base Adjustable arms	BALM/PU	1234
	White faux leather seat Polished alloy base Adjustable arms	BALM/WPU	1234
	Black faux leather seat Polished alloy base Adjustable arms Lumbar	BALML/PU	1318
	Black faux leather seat Polished alloy base Adjustable arms Headrest	BALH/PU	1563
	Upgrade Hardfloor caster	SOFTCAST	29
	Upgrade Chrome footring Bar height	BH_UP	276
	Upgrade Black leather seat cover	BALCOV/L	203
	Upgrade Breathe fabric seat cover	BALMCOV/BR#	62

- Select fabric - Seat covers

Breathe



Balance Seating





Product	Description	Code	USD
	Visitor Black frame Black mesh backrest Black fabric seat Fixed arms	BALV/BF	584
	Task Black frame Black mesh backrest Black fabric seat Adjustable arms Adjustable height	BALNTA/BF	713
	Training Black frame Black mesh backrest Black fabric seat Fixed arms	BALVA/BF	661
	Training Black frame Black mesh backrest Black fabric seat	BALVNA/BF	661
	Upgrade - Balance Task/Training Hardfloor caster	SOFTCAST	29
	Upgrade - Balance Training Tablet arm kit	ADATAB	134

Please note:

All seating on this page have seat covers which are not removable.

All seating products require partial assembly, except the Link chair and Otto stool.

Mode





Product	Description	Code	USD
	Highback Black faux leather seat	MODH/PU	998
	Highback White faux leather seat	MODH/WPU	
	Midback Black faux leather seat	MODM/PU	959
	Midback White faux leather seat	MODM/WPU	
	Guest Black faux leather seat	MODV/PU	794
	Guest White faux leather seat	MODV/WPU	
	Boardroom Black faux leather seat	MODMB/PU	959
	Boardroom White faux leather seat	MODMB/WPU	
	Upgrade Hardfloor caster	SOFTCAST	29

Please note:

All Mode seating with arm rests includes covers.

All seating products require partial assembly, except the Link chair and Otto stool.







Adapta

Product	Description	Code	USD
	Black backrest Black fabric seat Polished alloy base Adjustable arms	ADASBA/BF	518
	White backrest Black fabric seat Polished alloy base Adjustable arms	ADASWA/BF	518
	Upgrade Hardfloor caster	SOFTCAST	29
	Upgrade Tablet arm kit	ADATAB	134
	Upgrade Armless change kit <i>Required for Adapta chair with no arms</i>	ADAWOARM	22

Please note:

All seating products require partial assembly, except the Link chair and Otto stool.

Luna

Product	Description	Code	USD
	Chair Caster base Black shell Upholstered cushion	LUNAB_CAS/##	535
	Chair Caster base White shell Upholstered cushion	LUNAW_CAS/##	535
	Chair Oak base Black shell Upholstered cushion	LUNAB_OAK/##	557
	Chair Oak base White shell Upholstered cushion	LUNAW_OAK/##	557
	Barstool Oak base Black shell Upholstered cushion	LUNAB_BAR/##	620
	Barstool Oak base White shell Upholstered cushion	LUNAW_BAR/##	620







Please note:

All seating products require partial assembly, except the Link chair and Otto stool.

- Select fabric - upholstered cushion

Motion Felt **AS** **ST** **CL** **DB** **IC** **EM** **BB** **AV** **SO** **CR** Eurotex PU **B** **W**

Game

Product	Description	Code	USD
	Barstool Chrome frame Charcoal shell	GMBSRCRSCN	370
	Barstool Chrome frame Charcoal shell Upholstered seat	GMBSRCRSCS/B#	402
	Barstool Chrome frame Charcoal shell Upholstered seat + backrest	GMBSRCRSCF/B#	426
	Chair 4 Leg Chrome Charcoal shell	GM4LCRSCN	261
	Chair 4 Leg Chrome Charcoal shell Upholstered seat	GM4LCRSCS/B#	294
	Chair 4 Leg Chrome Charcoal shell Upholstered seat + backrest	GM4LCRSCF/B#	318

Please note:



All seating products require partial assembly, except the Link chair and Otto stool.

- Select fabric - upholstered cushion(s)

Breathe





Link

Product	Description	Code	USD
	Silver frame Black shell	LKS/B	164
	Silver frame White shell	LKS/W	164
	Upgrade Trolley Holds up to 25 chairs Black powdercoat	LK/TLY	488

Please note:

All seating products require partial assembly, except the Link chair and Otto stool.

Politan

Product	Description	Code	USD
	1 Seater Black faux leather	POL1/BPU	967
	2 Seater Black faux leather	POL2/BPU	1062

Otto

Product	Description	Code	USD
	Ottoman Includes casters	MOSTOOL_#	840

Please note:

All seating products require partial assembly, except the Link chair and Otto stool.

- Select fabric for Ottoman cover

Motion Felt AS ST CL DB IC EM BB AV SO CR





Tables

Modulus Overview	18
Modulus Flip.....	22
Modulus Fixed Tables	23
Modulus Collar Leg.....	24
Modulus Accessories.....	25
Modulus Frame Only	26
Axis Tables Overview	32
Axis Tables	34
Axis Bar Leaners	36
Uni Flip Overview.....	38
Uni Flip	39

Modulus Flip

Frames:

Black Matte or Arctic White Powdercoat finish to the posts, rails & pull bars
 Polished alloy feet

Worksurfaces:

1" M2 Grade substrate
 Studio White Melamine finish
 Matching 2mm PVC edge

Features:

Swiveling lockable casters
 Strong flip mechanism has safety stay upright locks

Flip - Small

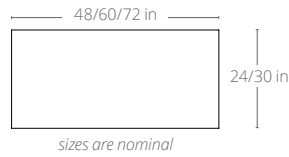
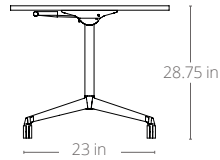

Flip - Large

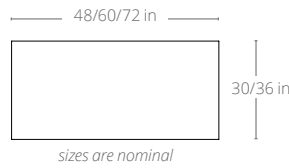
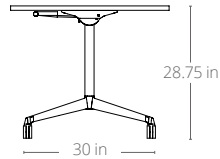

Additional Frame Details

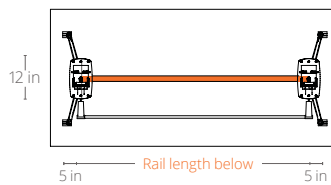
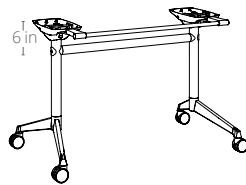
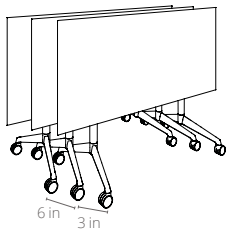

Rail Length Below	
FWFLRAIL50	= 20 in
FWFLRAIL80	= 32 in
FWFLRAIL110	= 44 in
FWFLRAIL140	= 56 in

Modulus Fixed Leg

Frames:

Black Matte Powdercoat finish to all posts & rails
 Polished alloy feet and worktop supports

Worksurfaces:

1" M2 Grade substrate
 Studio White Melamine finish
 Matching 2mm PVC edge

Features:

Leveling glides

Fixed Leg - Small

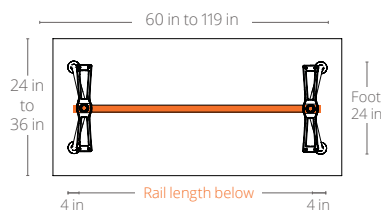
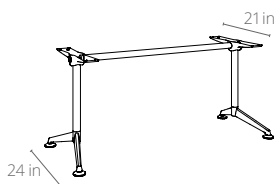

Rail Length Below	
FWTOPRAIL1000	= 40 in
FWTOPRAIL1100	= 50 in
FWTOPRAIL1300	= 58 in
FWTOPRAIL1600	= 68 in
FWTOPRAIL1900	= 81 in
FWTOPRAIL2200	= 93 in

Fixed Leg - Wide

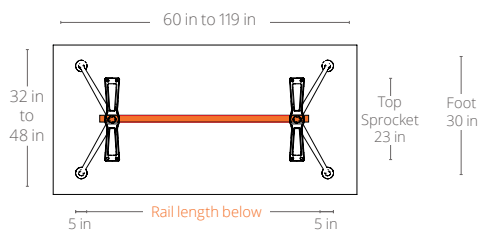
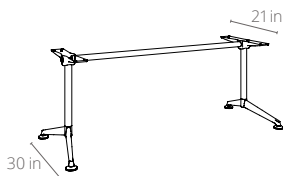

Rail Length Below	
FWTOPRAIL1000	= 40 in
FWTOPRAIL1100	= 50 in
FWTOPRAIL1300	= 58 in
FWTOPRAIL1600	= 68 in
FWTOPRAIL1900	= 81 in
FWTOPRAIL2200	= 93 in

Modulus Collar Leg

Frames:

Black Matte Powdercoat finish to all posts & rails
 Polished alloy feet and worktop supports

Worksurfaces:

1" M2 Grade substrate
 Stock Classic White LPL, 3 HPL woodgrains
 Matching 2mm PVC edge

Features:

Leveling glides

Collar Leg - Twin Post

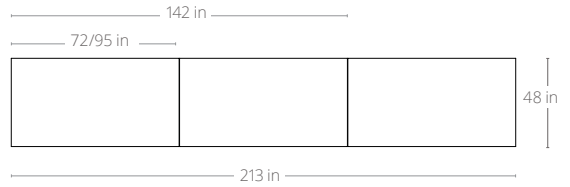
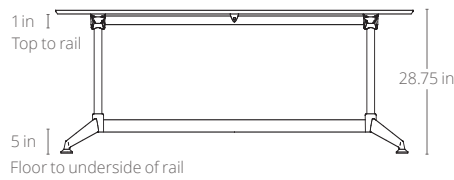

Additional Frame Details

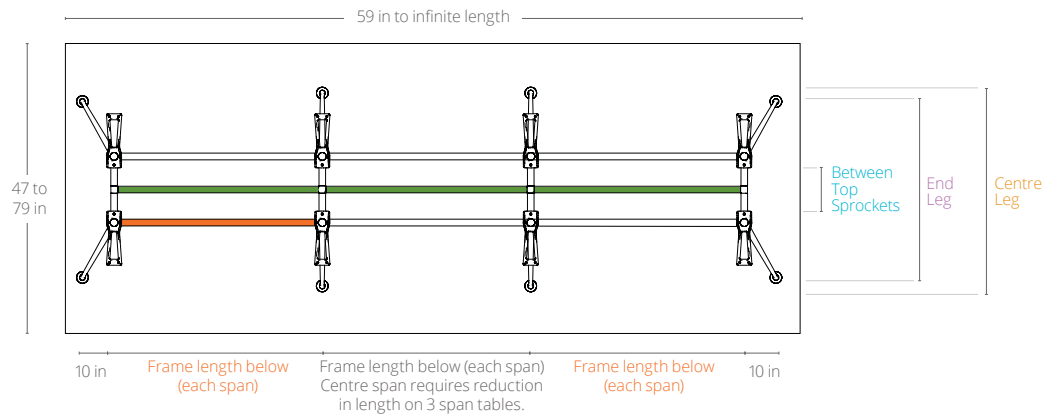

Top rail length (each span) Two beams per span	Lower beam length (each span) One beam per span
FWTOPRAIL1100 = 49 in	FWBOTRAIL1100 = 43 in
FWTOPRAIL1300 = 57 in	FWBOTRAIL1300 = 51 in
FWTOPRAIL1600 = 69 in	FWBOTRAIL1600 = 63 in
FWTOPRAIL1900 = 81 in	FWBOTRAIL1900 = 75 in
FWTOPRAIL2200 = 93 in	FWBOTRAIL2200 = 87 in



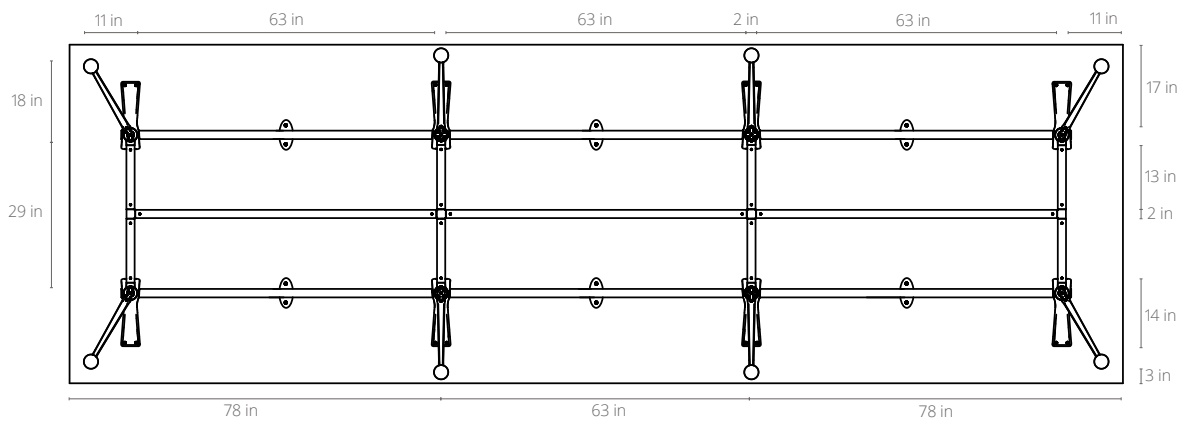
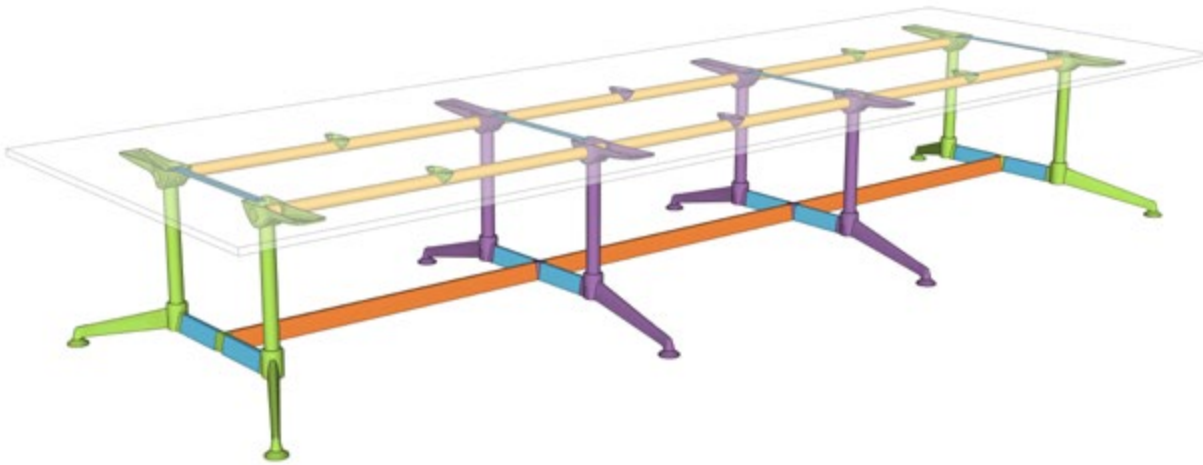

Leg Width Kit	End Leg	Centre Leg	Between Top Sprockets Alloy
FW1200	48 in	50 in	7 in
FW1400	55 in	54 in	12 in
FW1600	57 in	62 in	19 in
FW1800	66 in	70 in	27 in

Component Breakdown

Stockcode/Packs	Description	Quantity
FWMOD-04END_B	Twin Post End Leg Pair with Collar	1
FW1800SET_B	Width Connector Beam	2
FWMOD-04MID_B	Twin Post Centre Leg with Collar	2
FWTOPRAIL1600_B	Upper Rails	6
FWBOTRAIL1600_B	Lower Beam Set	3

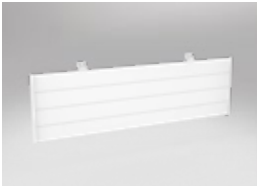

Modulus Flip

Product	Description	Worktop	Code	LPL	HPL
	Flip table Black posts & rails Polished aluminum feet 2x locking casters	48" x 24"	MFLIP126B/#	845	913
		60" x 24"	MFLIP156B/#	901	990
		72" x 24"	MFLIP186B/#	962	1044
		48" x 30"	MFLIP1275B/#	881	972
		60" x 30"	MFLIP1575B/#	948	1056
		72" x 30"	MFLIP1875B/#	1017	1151
		72" x 36"	MFLIP189B/#	1063	1232
	Flip table White posts & rails Polished aluminum feet 2x locking casters	48" x 24"	MFLIP126W/#	845	913
		60" x 24"	MFLIP156W/#	901	990
		72" x 24"	MFLIP186W/#	962	1044
		48" x 30"	MFLIP1275W/#	881	972
		60" x 30"	MFLIP1575W/#	948	1056
		72" x 30"	MFLIP1875W/#	1017	1151
		72" x 36"	MFLIP189W/#	1063	1232
	Accessories Flip table link		GANGMECH/B	63	
	Accessories Modesty kit Powdercoat	Suits top size 48" 31"w x 14"h	MFMOD125/@	230	
		Suits top size 60" 43"w x 14"h	MFMOD145/@	316	
		Suits top size 72" 55"w x 14"h	MFMOD165/@	402	
	Upgrade Cable tray 36" Length Undermount <i>Note: Fits 60"/72"W and 30"D tables only</i>		ELECTRAY900/W	193	

@ - Select modesty finish

Powdercoat





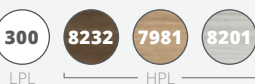

- Select worksurface finish

Laminate



Modulus Tables

Fixed leg

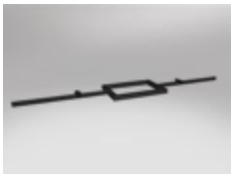
Product	Description	Worktop	Code	LPL	HPL
	Side table Single post	24" x 24" x 18" high	MT66/#	406	423
	Meeting table Single Post Fixed leg Round	36" diameter x 28.75" high	MT090R/#	581	642
		42" diameter x 28.75" high	MT105R/#	636	745
	Meeting table Single Post Fixed leg Square	39" x 39" x 28.75" high	MT1010/#	621	779
	Meeting table Four Post Fixed leg Round	60" diameter x 28.75" high	MT150R/#	1587	1757
	Meeting table 1 Piece Top Fixed leg Rectangle	72" x 24" x 28.75" high	MT186/#	904	986
		72" x 30" x 28.75" high	MT1875/#	935	1069
		72" x 36" x 28.75" high	MT189/#	959	1128
		60" x 24" x 28.75" high	MT156/#	826	915
		60" x 30" x 28.75" high	MT1575/#	881	989
		48" x 24" x 28.75" high	MT126/#	808	876
		48" x 30" x 28.75" high	MT1275/#	823	914
	Upgrade 92.5" post for single post tables to accommodate power module Black matte Suits power boxes up to 20" x 12" <i>Note: Can be cut down to suit shorter tops</i>		FWTOPRAILPBOX2200	371	



- Select worksurface finish

Laminate

300 8232 7981 3201
LPL HPL



Modulus Tables

Collar leg

Product	Description	Worktop	Code	LPL	HPL
	Meeting table 1 piece top Twin post	72" x 48" x 28.75" high	MT1812/#	1945	2145
		95" x 48" x 28.75" high	MT2412/#	2081	2396
	Meeting table 2 piece top Twin post	120" x 48" x 28.75" high	MT3012/#	3073	3451
		142" x 48" x 28.75" high	MT3612/#	3276	3676
	Meeting table 3 piece top Twin post	213" x 48" x 28.75" high	MT5412/#	4696	5296

Modulus Tables with Cutouts

Collar leg

Product	Description	Worktop	Code	LPL	HPL
	Meeting table 1-piece top Twin post 1 cutout for Interact power module (8.375" x 4.75")	72" x 48" x 28.75" high	MT1812/#-1C	1997	2197
		95" x 48" x 28.75" high	MT2412/#-1C	2122	2437
	Meeting table 2-piece top Twin post 2 cutouts for Interact power module (8.375" x 4.75")	120" x 48" x 28.75" high	MT3012/#-2C	3117	3495
		142" x 48" x 28.75" high	MT3612/#-2C	3379	3779
	Meeting table 3-piece top Twin post Includes 1-3 cutouts for Interact power module (8.375" x 4.75")	213" x 48" x 28.75" high	MT5412/#-1C	4747	5347
		213" x 48" x 28.75" high	MT5412/#-2C	4800	5400
		213" x 48" x 28.75" high	MT5412/#-3C	4851	5451

-1C, -2C, -3C in part number code, indicates how many sections require cutouts.

- Select worksurface finish

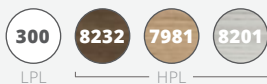

Laminate



LPL





HPL

Modulus Accessories

Product	Description	Code	USD
	<p>Power module White Includes 2 outlets, 3 RJ45 108" cord length Custom telecom plates available on special order</p>	ACT-21/GW-108	855
	<p>Cable cobra Black Power/data segregation</p>	CABCOBRA/B	88
	<p>Cable clutch - set of 5 White Below desk cable management</p>	CABCLUTCH_W	43







Modulus Flip

Frame only

Product	Description	Suits Worktop Length	Code	USD
	Flip table frame Black - standard Suits worksurface depth 24 - 36"	36" - 51"	MFLIP050/B	663
		48" - 63"	MFLIP080/B	682
		60" - 75"	MFLIP110/B	699
		72" - 84"	MFLIP140/B	724
	Flip table frame White - standard - Suits worksurface depth 24 - 36"	36" - 51"	MFLIP050/W	663
		48" - 63"	MFLIP080/W	682
		60" - 75"	MFLIP110/W	699
		72" - 84"	MFLIP140/W	724
	Flip table frame Black - large Suits worksurface depth 30" - 41"	36" - 51"	MFLIPL050/B	801
		48" - 63"	MFLIPL080/B	819
		60" - 75"	MFLIPL110/B	838
		72" - 84"	MFLIPL140/B	862
	Flip table frame White - large Suits worksurface depth 30" - 41"	36" - 51"	MFLIPL050/W	801
		48" - 63"	MFLIPL080/W	819
		60" - 75"	MFLIPL110/W	838
		72" - 84"	MFLIPL140/W	862

Modulus Tables



Frame only

Product	Description	Suits Worktop Size	Code	USD
	Meeting table frame Frame height: 17" Polished aluminum feet	16"-28" round 16"-24" square	CA-FWMOD11.16R/B	317
	Meeting table frame Frame height: 27.75" Polished aluminum feet	16"-28" round 16"-24" square	CA-FWMOD11.15R/B	319
	Meeting table frame Frame height: 27.75" Polished aluminum feet	32"-48" round 28"-39" square	CA-FWMOD11.1R/B	409
	Meeting table frame Frame height: 27.75" Polished aluminum feet	54"-72" round 48"-66" square	CA-FWMOD11.2R/B	1195
	Upgrade Bar-height poles Suitable for: Single post pedestal base	Frame height 41" High	MODZA22-808	131*
	Upgrade Bar-height poles Suitable for: 4 post pedestal base	Frame height 41" High	MODZA22-758	68*

*Price is per pole





Modulus Tables

Fixed leg - frame only

Product	Description	Suits Worktop Length	Code	USD
	Meeting table frame Small fixed leg Suits worksurface depth of 24"-30"	48"-54"	MT1206F/B	624
		55"-75"	MT1406F/B	626
		63"-83"	MT1606F/B	644
	Meeting table frame Large fixed leg Suits worksurface depth of 30"-36"	48"-54"	MT1208F/B	630
		55"-75"	MT1408F/B	646
		63"-83"	MT1608F/B	665
	Upgrade 92.5" Long post for single post tables to accommodate power module Black Suits powerboxes up to 20" x 12" Note: Can be cut down to suit shorter tops		FWTOPRAILPBOX2200	371

Modulus Tables





Collar leg - frame only

Product	Description	Suits Worktop Length	Code	USD
	Meeting table frame Single span Suits worksurface depth of 48"-54"	67"-83"	MT1412CC/B	1547
		74"-95"	MT1612CC/B	1548
		99"-118"	MT1912CC/B	1596
		110"-130"	MT2512CC/B	1695
	Meeting table frame Single span Suits worksurface depth of 55"-62"	67"-83"	MT1414CC/B	1565
		74"-95"	MT1614CC/B	1566
		99"-118"	MT1914CC/B	1614
		110"-130"	MT2514CC/B	1713
	Meeting table frame Single span Suits worksurface depth of 64"-69"	67"-83"	MT1416CC/B	1595
		74"-95"	MT1616CC/B	1595
		99"-118"	MT1916CC/B	1644
		110"-130"	MT2516CC/B	1743
	Meeting table frame Single span Suits worksurface depth of 72"-79"	67"-83"	MT1418CC/B	1598
		74"-95"	MT1618CC/B	1628
		99"-118"	MT1918CC/B	1675
		110"-130"	MT2518CC/B	1773
	Upgrade Bar-height poles Twin pole/four pole Pedestal base	Frame height 41" High	MODZA22-758	68*

*Price is per pole, order qty will depend on the size of the base.

Modulus Tables

Collar leg - frame only

Product	Description	Suits Worktop Length	Code	USD
	Meeting table frame Double Span Suits worksurface depth of 48"-54"	114"-130"	MT2612CC2/B	2375
		130"-146"	MT3012CC2/B	2435
		154"-169"	MT3612CC2/B	2546
		201"-217"	MT4812CC2/B	2728
	Meeting table frame Double Span Suits worksurface depth of 55"-62"	114"-130"	MT2614CC2/B	2403
		130"-146"	MT3014CC2/B	2462
		154"-169"	MT3614CC2/B	2583
		201"-217"	MT4814CC2/B	2756
	Meeting table frame Double Span Suits worksurface depth of 64"-69"	114"-130"	MT2616CC2/B	2445
		130"-146"	MT3016CC2/B	2504
		154"-169"	MT3616CC2/B	2625
		201"-217"	MT4816CC2/B	2756
	Meeting table frame Double Span Suits worksurface depth of 72"-79"	114"-130"	MT2618CC2/B	2493
		130"-146"	MT3018CC2/B	2551
		154"-169"	MT3618CC2/B	2673
		201"-217"	MT4818CC2/B	2847
	Upgrade Bar-height poles Twin pole/Four pole Pedestal base	41" High	MODZA22-758	68*

*Price is per pole, order qty will depend on the size of the base.

Modulus Tables

Collar leg - frame only

Product	Description	Suits Worktop Length	Code	USD
	Meeting table frame Triple Span Suits worksurface depth of 48"-54"	158"-177"	MT3712CC3/B	3207
		181"-201"	MT4312CC3/B	3294
		217"-232"	MT5212CC3/B	3493
		288"-303"	MT7012CC3/B	4354
	Meeting table frame Triple Span Suits worksurface depth of 55"-62"	158"-177"	MT3714CC3/B	3243
		181"-201"	MT4314CC3/B	3378
		217"-232"	MT5214CC3/B	3471
		288"-303"	MT7014CC3/B	4389
	Meeting table frame Triple Span Suits worksurface depth of 64"-69"	158"-177"	MT3716CC3/B	3300
		181"-201"	MT4316CC3/B	3396
		217"-232"	MT5216CC3/B	3527
		288"-303"	MT7016CC3/B	4446
	Meeting table frame Triple Span Suits worksurface depth of 72"-79"	158"-177"	MT3718CC3/B	3412
		181"-201"	MT4318CC3/B	3449
		217"-232"	MT5218CC3/B	3471
		288"-303"	MT7018CC3/B	4511

Axis Tables

Frames:

Silver or Arctic White
Powdercoat finish to all
posts and rails

Worksurfaces:

1" M2 Grade substrate
Studio White Melamine finish
Matching 2mm PVC edge

Coffee Table

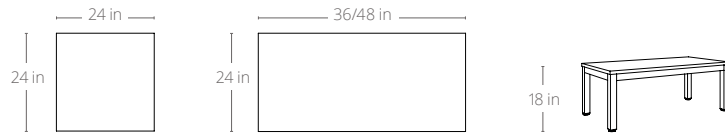

Meeting Table

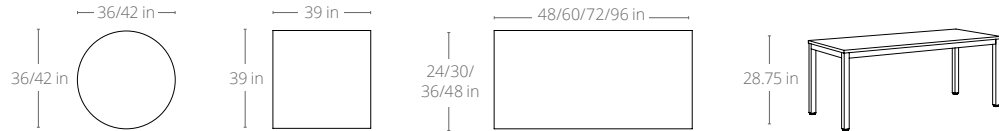

Axis Bar Leaner

Frames:

Black Matte or Arctic White
Powdercoat finish to all
posts and rails

Worksurfaces:

1" M2 Grade substrate
Studio White Melamine finish
Matching 2mm PVC edge

Bar Leaner

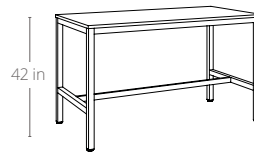
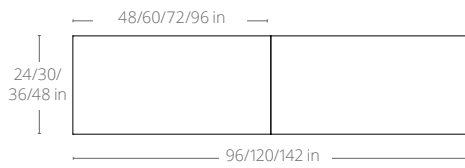

Axis Tables

Product	Description	Worktop	Code	LPL	HPL
	Coffee table 18" height	24" x 24"	AXCT66/##	403	420
		36" x 24"	AXCT96/##	492	534
		48" x 24"	AXCT126/##	564	632
	Meeting table 28.75" height	48" x 24"	AXT126/##	639	707
		60" x 24"	AXT156/##	707	796
		72" x 24"	AXT186/##	772	854
		48" x 30"	AXT1275/##	690	781
		60" x 30"	AXT1575/##	780	888
		72" x 30"	AXT1875/##	841	975
		72" x 36"	AXT189/##	859	1028
		60" x 48"	AXT1512/##	1122	1131
		72" x 48"	AXT1812/##	1013	1213
		96" x 48"	AXT2412/##	1043	1358
	Meeting table round 28.75" height	36" diameter	AXT090R/##	498	559
		42" diameter	AXT105R/##	515	624
		60" diameter	AXT150R/##	758	928
	Meeting table square 28.75" height	39" x 39"	AXT1010/##	657	815

- Select finishes

Powdercoat





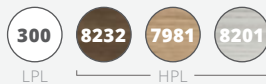

+ Laminate



Axis Tables

Frame only

Product	Description	Suits Worktop	Code	USD
	Coffee table 18" height	24" x 24"	AXCT66/#_F	344
		36" x 24"	AXCT96/#_F	376
		48" x 24"	AXCT126/#_F	399
	Meeting table 28.75" height	48" x 24"	AXT126/#_F	477
		60" x 24"	AXT156/#_F	508
		72" x 24"	AXT186/#_F	535
		48" x 30"	AXT1275/#_F	494
		60" x 30"	AXT1575/#_F	524
		72" x 30"	AXT1875/#_F	551
		72" x 36"	AXT189/#_F	566
		60" x 48"	AXT1512/#_F	766
		72" x 48"	AXT-1812/#_F	587
		96" x 48"	AXT-2412/#_F	626
		96" x 48" (Inset legs)	AXT2412I/#_F	626
			Meeting table round 28.75" height	36" diameter
42" diameter	AXT-105R/#_F			289
60" diameter	AXT-150R/#_F			289
	Meeting table square 28.75" height	39" x 39"	AXT-1010/#_F	289



- Select frame finish

Powdercoat

S

W

Axis Bar Leaner

Product	Description	Worktop	Code	LPL	HPL
	Bar leaner Single worktop	48" x 24"	AXBL1260/##	820	888
		60" x 24"	AXBL1560/##	872	961
		72" x 24"	AXBL1860/##	898	980
		48" x 30"	AXBL1275/##	962	1053
		60" x 30"	AXBL1575/##	966	1074
		72" x 30"	AXBL1875/##	1037	1171
		72" x 36"	AXBL1890/##	1075	1244
		60" x 48"	AXBL1512/##	1137	1326
		72" x 48"	AXBL1812/##	1237	1437
		96" x 48"	AXBL2412/##	1434	1749
	Bar leaner Double worktop	96" x 24"	AXBL2460/##	1506	1642
		120" x 24"	AXBL3060/##	1663	1841
		142" x 24"	AXBL3660/##	1799	1963
		96" x 30"	AXBL2475/##	1607	1789
		120" x 30"	AXBL3075/##	1788	2004
		142" x 30"	AXBL3675/##	1936	2204
		142" x 36"	AXBL3690/##	1992	2330
		120" x 48"	AXBL3012/##	2099	2477
		142" x 48"	AXBL3612/##	2299	2699

- Select finishes

Powdercoat



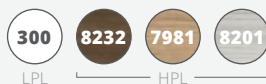

+ Laminate



Axis Bar Leaner

Frame only

Product	Description	Suits Worktop	Code	USD
	Bar leaner Frame only Single worktop`	48" x 24"	AXBL1260/#_F	659
		60" x 24"	AXBL1560/#_F	676
		72" x 24"	AXBL1860/#_F	698
		48" x 30"	AXBL1275/#_F	718
		60" x 30"	AXBL1575/#_F	730
		72" x 30"	AXBL1875/#_F	748
		72" x 36"	AXBL1890/#_F	785
		60" x 48"	AXBL1512/#_F	782
		72" x 48"	AXBL1812/#_F	818
		96" x 48"	AXBL2412/#_F	914
	Bar leaner Frame only Double worktop	96" x 24"	AXBL2460/#_F	1181
		120" x 24"	AXBL3060/#_F	1264
		142" x 24"	AXBL3660/#_F	1325
		96" x 30"	AXBL2475/#_F	1215
		120" x 30"	AXBL3075/#_F	1297
		142" x 30"	AXBL3675/#_F	1358
		142" x 36"	AXBL3690/#_F	1409
		120" x 48"	AXBL3012/#_F	1388
		142" x 48"	AXBL3612/#_F	1464

- Select frame finish

Powdercoat



Uni Flip

Frames:

Silver Powdercoat finish to all posts, rails & pull bars

Worksurfaces:

1" M2 Grade substrate
Studio White Melamine finish
Matching 2mm PVC edge

Features:

Swiveling lockable casters

Flip - Small

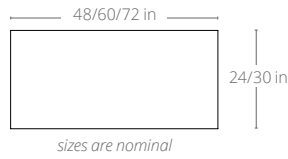
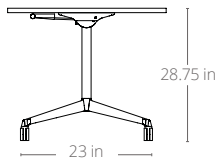

Additional Frame Details

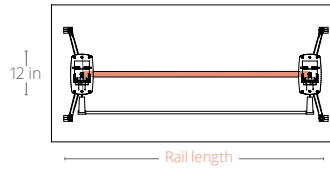
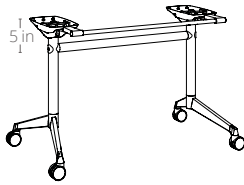
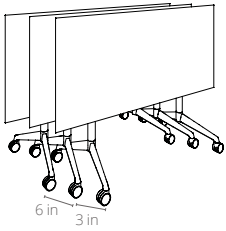

Rail Length	
FWFLRAIL50	= 32 in
FWFLRAIL80	= 42 in
FWFLRAIL110	= 55 in
FWFLRAIL140	= 67 in

Uni Flip

Product	Description	Worktop	Code	LPL	HPL
	Flip table Silver frame 2 x locking casters	48" x 24"	UNIFLIP1260S/#	776	844
		60" x 24"	UNIFLIP1560S/#	837	926
		72" x 24"	UNIFLIP1860S/#	898	980
		48" x 30"	UNIFLIP1275S/#	812	903
		60" x 30"	UNIFLIP1575S/#	883	991
		72" x 30"	UNIFLIP1875S/#	950	1084
		72" x 36"	UNIFLIP189S/#	954	1123
	Accessories Modesty kit Powdercoat	Suits top size 48", 31"w x 14"h	MFMOD125/@	230	
		Suits top size 60", 43"w x 14"h	MFMOD145/@	316	
		Suits top size 72", 55"w x 14"h	MFMOD165/@	402	
	Flip table link	Ganging mechanism	GANGMECH/B	63	
	Upgrade Cable tray 36" Length Undermount		ELECTRAY900/W	193	

Uni Flip - Frame Only

Product	Description	Suits Worktop Length	Code	USD
	Flip Table Frame only Silver frame 2 x locking casters Suits worksurface depth of 24"-36"	36" - 48"	UNIFLIP50/S	593
		48" - 60"	UNIFLIP80/S	612
		60" - 72"	UNIFLIP110/S	635
		72" - 96"	UNIFLIP140/S	659

- Select worksurface finish

Laminate

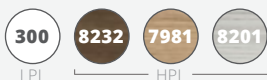

@ - Select modesty finish

Powdercoat







Desking

Agile Plus Overview	42
Agile Plus	43
Agile Overview	46
Agile Winder	47
Agile Electric	48
Agile Accessories.....	50
Axis Overview	54
Axis Desking	56
Axis Shared Desking	58
Axis Shared Workstations	62
Axis Dividers & Accessories.....	68
Axis Electrical	71
Anvil Overview	72
Anvil Desking.....	74
Anvil Shared Desking	76
Anvil Shared Workstations.....	80
Anvil Dividers & Accessories.....	86
Anvil Electrical.....	89

Agile Plus Desking

Frames:

Dual synchronized motors with microprocessor control and thermosensor
 Black or Arctic White
 Powdercoat finish to frame
 2.4" square legs
 Flat foot design - single sided desk
 H frame design - double sided desk
 Height adjustable - electric

Worksurfaces:

1" M2 Grade substrate
 4 Melamine finish options
 Matching 2mm PVC edge

Features:

Ultra quiet dual motor frame
 2 controller options, memory presets
 Super soft start stop
 Anti-collision software
 Weight rating: 225lbs
 Electric speed: 1.6"/s

Single Sided Desk

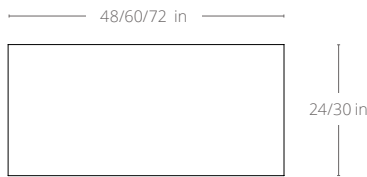

Double Sided Desk

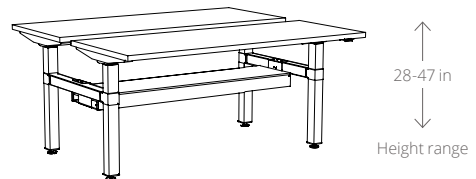
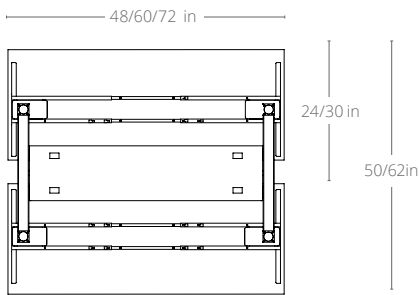

90° Workstation

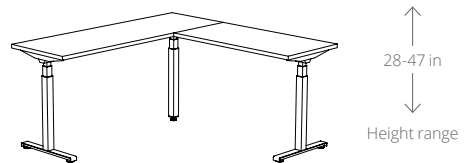
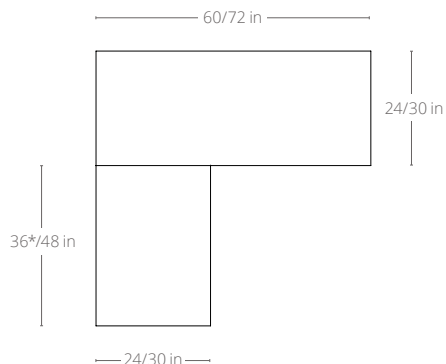

* 36 in return surface only available in 24 in depth

Agile Plus Desking

Electric height adjustable

Product	Description	Worktop	Code	LPL	HPL
	Single sided desk Electric adjust	48" x 24"	AGPE2SSD126/##	1325	1393
		48" x 30"	AGPE2SSD1275/##	1358	1449
		60" x 24"	AGPE2SSD156/##	1361	1450
		60" x 30"	AGPE2SSD1575/##	1408	1516
		72" x 24"	AGPE2SSD186/##	1400	1482
		72" x 30"	AGPE2SSD1875/##	1451	1585
	Double sided desk Electric adjust	2@ 48" x 24"	AGPE2DSD126/##	2553*	2689*
		2@ 48" x 30"	AGPE2DSD1275/##	2619*	2801*
		2@ 60" x 24"	AGPE2DSD156/##	2625*	2803*
		2@ 60" x 30"	AGPE2DSD1575/##	2719*	2935*
		2@ 72" x 24"	AGPE2DSD186/##	2703*	2867*
		2@ 72" x 30"	AGPE2DSD1875/##	2805*	3073*
	Single sided desk Frame only Electric adjust	48" x 24"	AGPE2SSD126/#_F	1159	
		48" x 30"	AGPE2SSD1275/#_F	1159	
		60" x 24"	AGPE2SSD156/#_F	1159	
		60" x 30"	AGPE2SSD1575/#_F	1159	
		72" x 24"	AGPE2SSD186/#_F	1159	
		72" x 30"	AGPE2SSD1875/#_F	1159	
	Double sided desk Frame only Electric adjust	2@ 48" x 24"	AGPE2DSD126/#_F	1762*	
		2@ 48" x 30"	AGPE2DSD1275/#_F	1762*	
		2@ 60" x 24"	AGPE2DSD156/#_F	1764*	
		2@ 60" x 30"	AGPE2DSD1575/#_F	1764*	
		2@ 72" x 24"	AGPE2DSD186/#_F	1841*	
		2@ 72" x 30"	AGPE2DSD1875/#_F	1841*	
	Upgrade Modesty panel Laminate	42.5" wide x 12" deep	AGM12/#	81	107
		54.5" wide x 12" deep	AGM15/#	82	109
		66.25" wide x 12" deep	AGM18/#	97	128

*Price is per back-to-back unit

- Select finishes

Powdercoat



+ Laminate

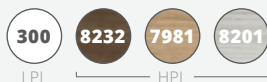

Agile Plus Workstations

Electric height adjustable

Product	Description	Worktop	Code	LPL	HPL
	Left hand return 90° Electric adjust	60' x 24"/36" x 24"	AGP3MEW1561656/#L#	2323	2454
		60' x 24"/48" x 24"	AGP3MEW156186/#L#	2372	2529
		60' x 30"/36" x 24"	AGP3MEW15751656/#L#	2370	2520
		72' x 24"/36" x 24"	AGP3MEW1861656/#L#	2362	2486
		72' x 24"/48" x 24"	AGP3MEW186186/#L#	2411	2561
		72' x 30"/36" x 24"	AGP3MEW18751656/#L#	2413	2589
	Right hand return 90° Electric adjust	60' x 24"/36" x 24"	AGP3MEW1561656/#R#	2323	2454
		60' x 24"/48" x 24"	AGP3MEW156186/#R#	2372	2529
		60' x 30"/36" x 24"	AGP3MEW15751656/#R#	2370	2520
		72' x 24"/36" x 24"	AGP3MEW1861656/#R#	2362	2486
		72' x 24"/48" x 24"	AGP3MEW186186/#R#	2411	2561
		72' x 30"/36" x 24"	AGP3MEW18751656/#R#	2413	2589
	90° Workstation Frame only Electric adjust	60"-72" x 60"-72" / 24"-30"	AG3MEW18186/#_F	2004	

Controller Upgrade

	Controller Pro 4 memory presets Electronic display	AGMP4/B	86
---	---	---------	----

- Select finishes

Powdercoat



+ Laminate

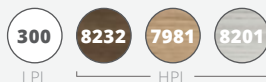

Agile Plus Cable Management

Product	Description	Dimensions	Code	USD
	Cable tray* Single sided	48" Length	AGPSSDCM12/#	366
		60" Length	AGPSSDCM15/#	498
		72" Length	AGPSSDCM18/#	531
	Cable tray* Double sided	48" Length	AGPDSDCM12/#	311
		60" Length	AGPDSDCM15/#	344
		72" Length	AGPDSDCM18/#	417
	Bridge with cover* For single sided desk		AGPSBRIDGE/#	99
	Bridge with cover* For double sided desk		AGPDBRIDGE/B	81
	Cable tray Undermount	36" Length	ELECTRAY900/#	193
	Cable cobra	42.5" Length	CABCOBRA/#	88
	Cable clutch Set of 5		CABCLUTCH_W	43

***Please note:**

Cable trays shown above are only applicable to Agile Plus and not standard Agile. See page 49 for standard Agile cable management.

- Select finish

Colour



Agile Desking

Frames:

Black or Arctic White
 Powdercoat finish to frame
 3.55 x 2.4" legs
 Flat foot design - single
 sided desk
 H frame design - double
 sided desk
 Height adjustable - electric
 or winder

Worksurfaces:

1" M2 Grade substrate
 Studio White Melamine
 finish
 Matching 2mm PVC edge

Features:

Weight rating 250lbs
 Winder speed: ¼"/turn
 Electric speed: 1"/s

Single Sided Desk

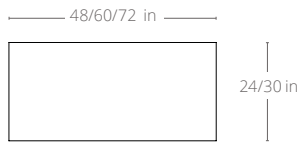

Double Sided Desk

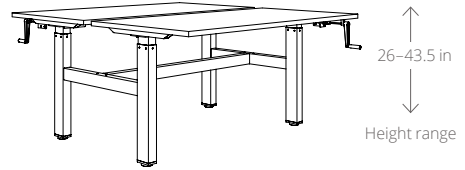
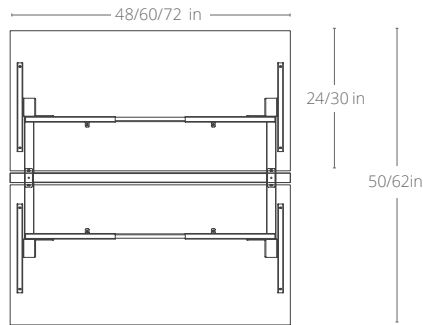

90° Workstation

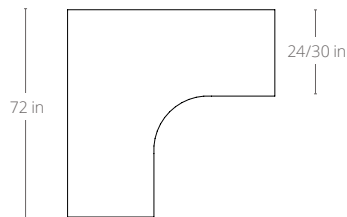

120° Workstation

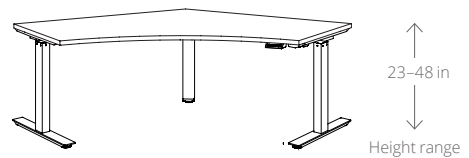
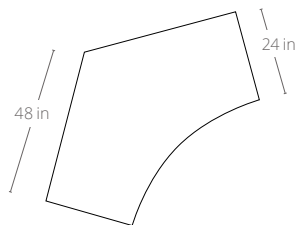

Agile Desking

Winder height adjustable

Product	Description	Worktop	Code	LPL	HPL
	Single sided desk Winder adjust	48" x 24"	AGWSSD126/##	953	1021
		48" x 30"	AGWSSD1275/##	981	1072
		60" x 24"	AGWSSD156/##	1011	1100
		60" x 30"	AGWSSD1575/##	1020	1128
		72" x 24"	AGWSSD186/##	1042	1124
		72" x 30"	AGWSSD1875/##	1084	1218
	Double sided desk Winder adjust	2@ 48" x 24"	AGWDSD126/##	2031*	2167
		2@ 48" x 30"	AGWDSD1275/##	2083*	2265
		2@ 60" x 24"	AGWDSD156/##	2093*	2271
		2@ 60" x 30"	AGWDSD1575/##	2166*	2382
		2@ 72" x 24"	AGWDSD186/##	2228*	2392
		2@ 72" x 30"	AGWDSD1875/##	2313*	2581
	Single sided desk Frame only Winder adjust	48" x 24"	AGWSSD126/#_F	820	
		48" x 30"	AGWSSD1275/#_F	820	
		60" x 24"	AGWSSD156/#_F	820	
		60" x 30"	AGWSSD1575/#_F	820	
		72" x 24"	AGWSSD186/#_F	849	
		72" x 30"	AGWSSD1875/#_F	849	
	Double sided desk Frame only Winder adjust	2@ 48" x 24"	AGWDSD126/#_F	1762*	
		2@ 48" x 30"	AGWDSD1275/#_F	1762*	
		2@ 60" x 24"	AGWDSD156/#_F	1764*	
		2@ 60" x 30"	AGWDSD1575/#_F	1764*	
		2@ 72" x 24"	AGWDSD186/#_F	1841*	
		2@ 72" x 30"	AGWDSD1875/#_F	1841*	
	Upgrade Modesty panel Laminate	42.5" wide x 12" deep	AGM12/#	81	107
		54.5" wide x 12" deep	AGM15/#	82	109
		66.25" wide x 12" deep	AGM18/#	97	128

*Price is per back-to-back unit

- Select finishes

Powdercoat



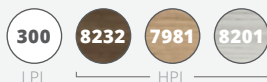

+ Laminate



Agile Desking

Electric height adjustable

Product	Description	Worktop	Code	LPL	HPL
	Single sided desk Electric adjust	48" x 24"	AGE2SSD126/#	1350	1418
		48" x 30"	AGE2SSD1275/#	1379	1470
		60" x 24"	AGE2SSD156/#	1380	1469
		60" x 30"	AGE2SSD1575/#	1417	1525
		72" x 24"	AGE2SSD186/#	1438	1520
		72" x 30"	AGE2SSD1875/#	1482	1616
	Double sided desk Electric adjust	2@ 48" x 24"	AGE2DSD126/#	2671*	2807*
		2@ 48" x 30"	AGE2DSD1275/#	2727*	2909*
		2@ 60" x 24"	AGE2DSD156/#	2733*	2911*
		2@ 60" x 30"	AGE2DSD1575/#	2807*	3023*
		2@ 72" x 24"	AGE2DSD186/#	2867*	3031*
		2@ 72" x 30"	AGE2DSD1875/#	2954*	3222*
	Single sided desk Frame only Electric adjust	48" x 24"	AGE2SSD126/#_F	1217	
		48" x 30"	AGE2SSD1275/#_F	1217	
		60" x 24"	AGE2SSD156/#_F	1217	
		60" x 30"	AGE2SSD1575/#_F	1217	
		72" x 24"	AGE2SSD186/#_F	1245	
		72" x 30"	AGE2SSD1875/#_F	1245	
	Double sided desk Frame only Electric adjust	2@ 48" x 24"	AGE2DSD126/#_F	2408*	
		2@ 48" x 30"	AGE2DSD1275/#_F	2408*	
		2@ 60" x 24"	AGE2DSD156/#_F	2410*	
		2@ 60" x 30"	AGE2DSD1575/#_F	2410*	
		2@ 72" x 24"	AGE2DSD186/#_F	2482*	
		2@ 72" x 30"	AGE2DSD1875/#_F	2482*	
	Upgrade Modesty panel Laminate	42.5" wide x 12" deep	AGM12/W	81	107
		54.5" wide x 12" deep	AGM15/W	82	109
		66.25" wide x 12" deep	AGM18/W	97	128

*Price is per back-to-back unit

- Select finishes

Powdercoat





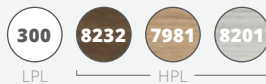

+ Laminate



Agile Workstations

Electric height adjustable

Product	Description	Worktop	Code	LPL	HPL
	90° Workstation - Left Electric adjust	72" x 72"/24"	AG3MEW18186/WL300		2794
		72" x 72"/30"	AG3MEW181875/WL300		2824
	90° Workstation - Right Electric adjust	72" x 72"/24"	AG3MEW18186 WR300		2794
		72" x 72"/30"	AG3MEW181875 WR300		2824
	120° Workstation Electric adjust	48" x 48"/24"	AG3MEW12126/#	2804	3084
	90° Workstation Frame only Electric adjust	60"-76" x 60"-76"/24"	AG3MEW18186/#_F		2383
		60"-76" x 60"-76"/30"	AG3MEW181875/#_F		2383
	120° Workstation Frame only Electric adjust	48"-72" x 48"-72"/24"	AG3MEW12126/#_F		2383

- Select finishes





Powdercoat

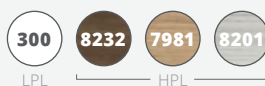

+ Laminate

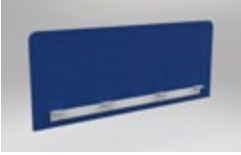
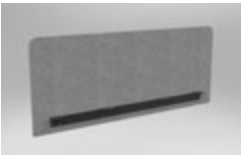

Agile e-Panel Screens

Product	Description	Dimensions	Code	USD
	Clamp on Screen* E-panel .75" thickness	47"W x 24"H	EPSSD120060/#	212
	*Not for Agile Plus	59"W x 24"H	EPSSD150060/#	350
	Edge Undermount White bracket E-panel .75" thickness	47"W x 24"H	AGESE120060/W#	265
		59"W x 24"H	AGESE150060/W#	378
	Edge Undermount Black bracket E-panel .75" thickness	47"W x 24"H	AGESE120060/B#	265
		59"W x 24"H	AGESE150060/B#	378
	Return Screen E-panel Pure Black 1" thickness	23"W x 12"H	SSCRN6030/PB10	162
		29"W x 12"H	SSCRN7530/PB10	171
	Return Screen E-panel Spectrum Red 1" thickness	23"W x 12"H	SSCRN6030/SP15	162
		29"W x 12"H	SSCRN7530/SP15	171
	Return Screen E-panel Deep Grey 1" thickness	23"W x 12"H	SSCRN6030/DG37	162
		29"W x 12"H	SSCRN7530/DG37	171
	Return Screen E-panel Bright Blue 1" thickness	23"W x 12"H	SSCRN6030/BB21	162
		29"W x 12"H	SSCRN7530/BB21	171

- Select finishes

e-Panel

SP15





DG37

BB21

*Please note:

Spine screens marked (*) are only applicable to standard Agile and not Agile Plus.

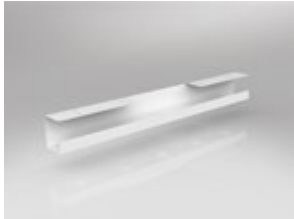
Agile Cable Management

Product	Description	Dimensions	Code	USD
	Cable tray* Single sided <i>*Not for Agile Plus</i>	48" Length	AGSSDCM12/#	366
		60" Length	AGSSDCM15/#	498
		72" Length	AGSSDCM18/#	531
	Cable tray* Double sided <i>*Not for Agile Plus</i>	48" Length	AGSDCM12/#	311
		60" Length	AGSDCM15/#	344
		72" Length	AGSDCM18/#	417
	Cable tray Undermount	36" Length	ELECTRAY900/#	193
	Cable cobra	42.5" Length	CABCOBRA/#	88
	Cable clutch Set of 5		CABCLUTCH_W	43

***Please note:**

Cable trays marked (*) are only applicable to standard Agile and not Agile Plus. See page 43 for Agile Plus cable management.



- Select finish

Colour

B

W

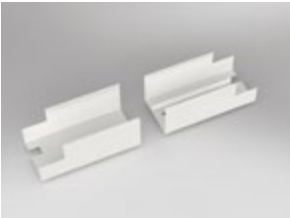
Agile Brackets





Product	Description	Dimensions	Code	USD
	Brackets (pair) For single sided desk cable tray	24"-32" deep	AGSSDBRAC/#	113
	Bridge with cover For single sided desk		AGSBRIDGE/#-IT-C	79
	Bridge with cover For double sided desk		AGDBRIDGE/#-1-C	93

- Select finish

Powdercoat



Agile Electrical

Product	Description	Dimensions	Code	USD
	Voltra Agile I - White 3 outlets 2 USB 108" cord		AGPM3O2U-W-108	219
	Voltra power module 3 outlets 1 USB-A, 1 USB-C 108" cord		AGPM3O1U1C-W-108	232
	Voltra power module 3 outlets 1 USB-A, 1 USB-C 108" cord		AGPM3O1U1C-B-108	232
	One Duplex For one duplex in tray		ELECTRICAL_1	188
	Two Duplex For two duplexes in tray		ELECTRICAL_2	343
	Base Infeed Hardwire	Standard - 72"	EHINFD-72	207
		NYC - 72"	EHNYCINFD-72	207
	Ceiling Infeed Hardwire	Standard - 144"	EHINFD-144	249
		NYC - 144"	EHNYCINFD-144	249

Please note:
 All electrical prices include all required jumper cables, connecting hardware, duplexes, electrical face plate, and data face plate with four knockouts.

Axis Desking

Frames:

Arctic White or Silver
 Powdercoat finish to frame
 2 x 2" square legs
 2 x 1" rails
 28.75" Worksurface height

Worksurfaces:

1" M2 Grade substrate
 Studio White Melamine finish
 Matching 2mm PVC edge
 90° worksurface comes as with join at 47" along the left or right hand side

Spine Screens:

Translucent or E-panel insert to top 11.82"
 White Melamine below
 0.82" thickness
 Sits 19.7" above desk height
 All brackets & trims included
 E-panel is available in Ignite Red or Black and has a tackable core

Desk

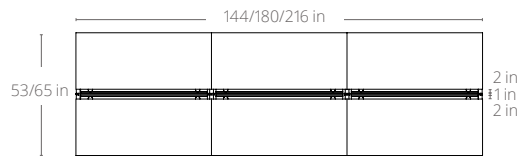

90° Workstation

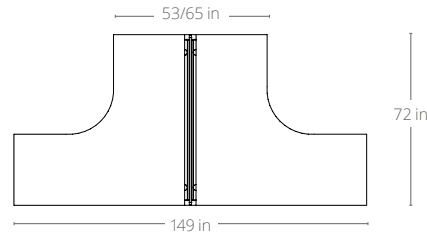
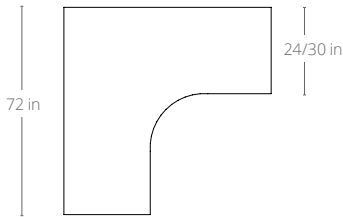

120° Workstation

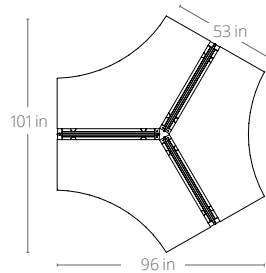
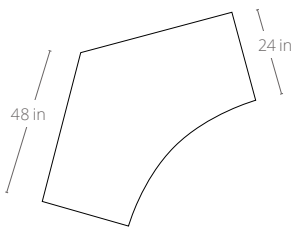

Desk & Return

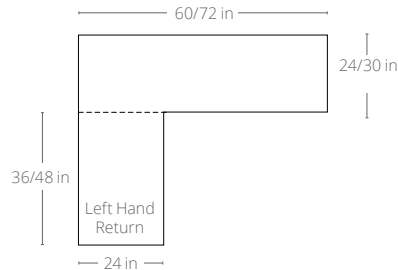

* All dimensions are nominal

Standard Dividers

Spine Screens

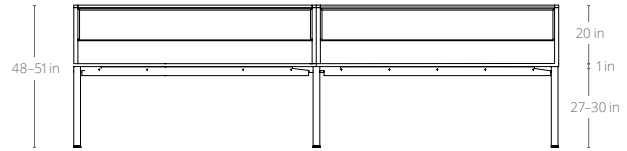
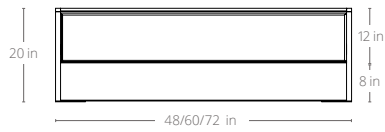

Desk Hung Screens

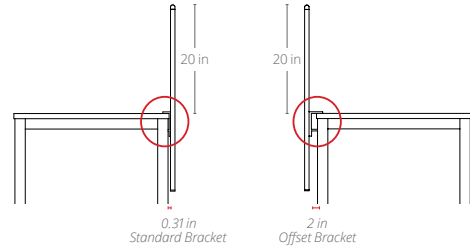
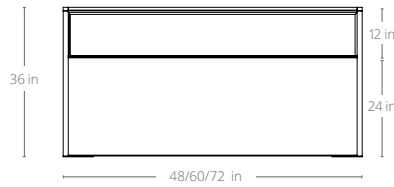

Return Screens

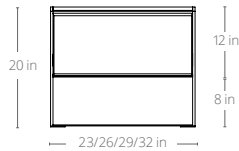

Devise Dividers

Spine Screens

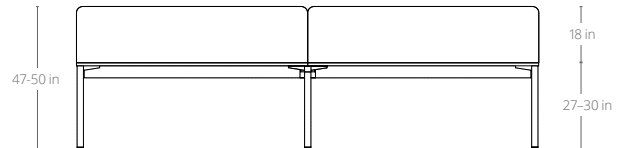
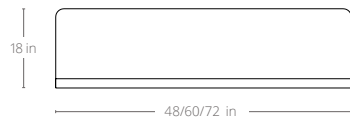

Desk Hung Screens

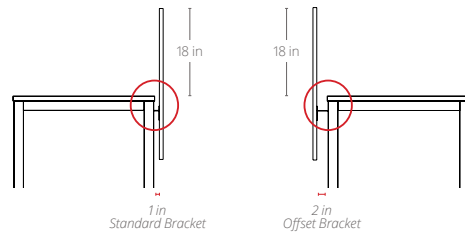



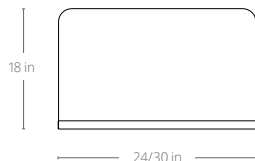

Return Screens



* All dimensions are nominal

Axis Desking

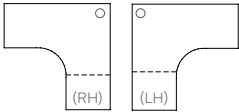

Product	Description	Worktop	Code	LPL	HPL
	Desk Fixed height	48" x 24"	AXSD126/##	527	595
		48" x 30"	AXSD1275/###	598	689
		60" x 24"	AXSD156/##	581	670
		60" x 30"	AXSD1575/###	661	769
		72" x 24"	AXSD186/##	628	710
		72" x 30"	AXSD1875/###	715	849
		72" x 36" <i>Includes 6" conference front</i>	AXSD189/##	720	889
	90° Workstation Fixed height	72" x 72"/24"	AX9W18186/#L300	1053	
		72" x 72"/24"	AX9W18186/#R300	1053	
		72" x 72"/30"	AX9W181875/#L300	1106	
		72" x 72"/30"	AX9W181875/#R300	1106	
	120° Workstation Fixed height	48" x 48"/24"	AX12W12126/##	1194	1474
	Upgrade Modesty panel Laminate	42.5" wide x 12" deep	AXM12/#	87	113
		54.5" wide x 12" deep	AXM15/#	90	117
		66.25" wide x 12" deep	AXM18/#	104	135



- Select finishes

Powdercoat frame **S** **W** + Laminate **300** **8232** **7981** **8201**
LPL HPL

Axis Desk & Return

Product	Description	Worktop	Code	LPL	HPL
	Left hand return Fixed height	60" x 24"/36" x 24"	AXDR156156/#L#	847	978
		60" x 30"/36" x 24" <i>Includes 6" conference front</i>	AXDR1575176/#L#	1227	1377
		60" x 24"/48" x 24"	AXDR156186/#L#	905	1062
		60" x 30"/48" x 24" <i>Includes 6" conference front</i>	AXDR1575206/#L#	1294	1470
		72" x 24"/36" x 24"	AXDR186156/#L#	895	1019
		72" x 30"/36" x 24" <i>Includes 6" conference front</i>	AXDR1875176/#L#	1282	1458
		72" x 24"/48" x 24"	AXDR186186/#L#	955	1105
		72" x 30"/48" x 24" <i>Includes 6" conference front</i>	AXDR1875206/#L#	1348	1550
	Right hand return Fixed height	60" x 24"/36" x 24"	AXDR156156/#R#	847	978
		60" x 30"/36" x 24" <i>Includes 6" conference front</i>	AXDR1575176/#R#	1227	1377
		60" x 24"/48" x 24"	AXDR156186/#R#	905	1062
		60" x 30"/48" x 24" <i>Includes 6" conference front</i>	AXDR1575206/#R#	1294	1470
		72" x 24"/36" x 24"	AXDR186156/#R#	895	1019
		72" x 30"/36" x 24" <i>Includes 6" conference front</i>	AXDR1875176/#R#	1282	1458
		72" x 24"/48" x 24"	AXDR186186/#R#	955	1105
		72" x 30"/48" x 24" <i>Includes 6" conference front</i>	AXDR1875206/#R#	1348	1550
	Upgrade Modesty panel Laminate	42.5" wide x 12" deep	AXM12/#	87	113
		54.5" wide x 12" deep	AXM15/#	90	117
		66.25" wide x 12" deep	AXM18/#	104	135

- Select finishes



Powdercoat frame

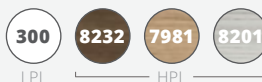

+ Laminate



Axis Shared Desking

Product	Description	Worktop	Code	LPL*	HPL*
	Desk Single sided 2 User	2 @ 48" x 24"	AX2SSD126/##	942	1078
		2 @ 48" x 30"	AX2SSD1275/##	1071	1253
		2 @ 60" x 24"	AX2SSD156/##	1048	1226
		2 @ 60" x 30"	AX2SSD1575/##	1199	1415
		2 @ 72" x 24"	AX2SSD186/##	1145	1309
		2 @ 72" x 30"	AX2SSD1875/##	1309	1577
	Desk Single sided 3 User	3 @ 48" x 24"	AX3SSD126/##	1357	1561
		3 @ 48" x 30"	AX3SSD1275/##	1544	1817
		3 @ 60" x 24"	AX3SSD156/##	1519	1786
		3 @ 60" x 30"	AX3SSD1575/##	1742	2066
		3 @ 72" x 24"	AX3SSD186/##	1659	1905
		3 @ 72" x 30"	AX3SSD1875/##	1904	2306
	Upgrade Modesty panel Laminate	42.5" wide x 12" deep	AXM12/#	87	113
		54.5" wide x 12" deep	AXM15/#	90	117
		66.25" wide x 12" deep	AXM18/#	104	135



*All shared desking shows pricing per pod.

Please note:
 Single sided desk cable management can be found on page 102

- Select finishes

Powdercoat frame S W + Laminate 300 8232 7981 8201
LPL HPL

Axis Shared Desking

Product	Description	Worktop	Code	LPL*	HPL*
	Desk Double sided 2 User Cable trays	2 @ 48" x 24"	AX2DSD126/###	1178	1314
		2 @ 48" x 30"	AX2DSD1275/###	1276	1458
		2 @ 60" x 24"	AX2DSD156/###	1321	1499
		2 @ 60" x 30"	AX2DSD1575/###	1443	1659
		2 @ 72" x 24"	AX2DSD186/###	1468	1632
		2 @ 72" x 30"	AX2DSD1875/###	1599	1867
	Desk Double sided 4 User Cable trays	4 @ 48" x 24"	AX4DSD126/###	2079	2351
		4 @ 48" x 30"	AX4DSD1275/###	2249	2613
		4 @ 60" x 24"	AX4DSD156/###	2360	2716
		4 @ 60" x 30"	AX4DSD1575/###	2571	3003
		4 @ 72" x 24"	AX4DSD186/###	2650	2978
		4 @ 72" x 30"	AX4DSD1875/###	2890	3426
	Desk Double sided 6 User Cable trays	6 @ 48" x 24"	AX6DSD126/###	2975	3383
		6 @ 48" x 30"	AX6DSD1275/###	3236	3782
		6 @ 60" x 24"	AX6DSD156/###	3404	3938
		6 @ 60" x 30"	AX6DSD1575/###	3714	4362
		6 @ 72" x 24"	AX6DSD186/###	3838	4330
		6 @ 72" x 30"	AX6DSD1875/###	4174	4978

*All shared desking shows pricing per pod.

Please note:

Cable tray covers can be found on page 103

- Select finishes

Powdercoat frame



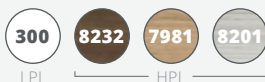

+ Laminate



Axis Shared Desking

With standard screens

Product	Description	Worktop	Code	LPL*	HPL*
 <p>Desk Double sided 2 User Spine screens Cable trays</p>		2 @ 48" x 24"	AX2DSD126/###	1468	1604
		2 @ 48" x 30"	AX2DSD1275/###	1565	1747
		2 @ 60" x 24"	AX2DSD156/###	1692	1870
		2 @ 60" x 30"	AX2DSD1575/###	1812	2028
		2 @ 72" x 24"	AX2DSD186/###	1882	2046
		2 @ 72" x 30"	AX2DSD1875/###	2017	2285
 <p>Desk Double sided 4 User Spine screens Cable trays</p>		4 @ 48" x 24"	AX4DSD126/###	2683	2955
		4 @ 48" x 30"	AX4DSD1275/###	2849	3213
		4 @ 60" x 24"	AX4DSD156/###	3130	3486
		4 @ 60" x 30"	AX4DSD1575/###	3337	3769
		4 @ 72" x 24"	AX4DSD186/###	3515	3843
		4 @ 72" x 30"	AX4DSD1875/###	3751	4287
 <p>Desk Double sided 6 User Spine screens Cable trays</p>		6 @ 48" x 24"	AX6DSD126/###	3888	4296
		6 @ 48" x 30"	AX6DSD1275/###	4136	4682
		6 @ 60" x 24"	AX6DSD156/###	4565	5099
		6 @ 60" x 30"	AX6DSD1575/###	4882	5530
		6 @ 72" x 24"	AX6DSD186/###	5149	5641
		6 @ 72" x 30"	AX6DSD1875/###	5484	6288

*All shared desking shows pricing per pod.

Please note:

Comseal covers can be found on page 102



- Select finishes

Powdercoat frame (desk)
S
W
 + **Laminate**
300
8232
7981
8201
 + **Screen insert**
I
B
T

LPL
HPL
e-Panel
PVC

Axis Shared Desking

With Devise screens

Product	Description	Worktop	Code	LPL*	HPL*
	Desk Double sided 2 User Spine screens Cable trays	2 @ 48" x 24"	AX2DSD126/###	1651	1787
		2 @ 48" x 30"	AX2DSD1275/###	1761	1943
		2 @ 60" x 24"	AX2DSD156/###	1903	2081
		2 @ 60" x 30"	AX2DSD1575/###	2037	2253
		2 @ 72" x 24"	AX2DSD186/###	2117	2281
		2 @ 72" x 30"	AX2DSD1875/###	2268	2536
	Desk Double sided 4 User Spine screens Cable trays	4 @ 48" x 24"	AX4DSD126/###	3019	3291
		4 @ 48" x 30"	AX4DSD1275/###	3205	3569
		4 @ 60" x 24"	AX4DSD156/###	3522	3878
		4 @ 60" x 30"	AX4DSD1575/###	3754	4186
		4 @ 72" x 24"	AX4DSD186/###	3954	4282
		4 @ 72" x 30"	AX4DSD1875/###	4220	4756
	Desk Double sided 6 User Spine screens Cable trays	6 @ 48" x 24"	AX6DSD126/###	4373	4781
		6 @ 48" x 30"	AX6DSD1275/###	4653	5199
		6 @ 60" x 24"	AX6DSD156/###	5135	5669
		6 @ 60" x 30"	AX6DSD1575/###	5491	6139
		6 @ 72" x 24"	AX6DSD186/###	5791	6283
		6 @ 72" x 30"	AX6DSD1875/###	6169	6973

*All shared desking shows pricing per pod.

Please note:

Eclipse tray covers can be found on page 69

- Select finishes

Powdercoat frame (desk)



+

Laminate





+

E-Panel Color



LPL HPL

Axis 90° Workstations

Product	Description	Worktop	Code	LPL*	HPL*
	90° Workstation 2 User	2 @ 72" x 72" x 24"	AX2U186186/##	1780	2080
		2 @ 72" x 72" x 30"	AX2U187187/##	1990	2440
	90° Workstation T layout 2 User Cable trays	2 @ 72" x 72" x 24"	AX2T186186/##	2169	2469
		2 @ 72" x 72" x 30"	AX2T187187/##	2371	2821
	90° Workstation Plus layout 4 User Cable trays	4 @ 72" x 72" x 24"	AX4P186186/##	4892	5492
		4 @ 72" x 72" x 30"	AX4P187187/##	5259	6159
	90° Workstation H layout 4 User Cable trays	4 @ 72" x 72" x 24"	AX4H186186/##	4055	4655
		4 @ 72" x 72" x 30"	AX4H187187/##	4431	5331
	90° Workstation 6 User Cable trays	6 @ 72" x 72" x 24"	AX6PT186186/##	6766	7666
		6 @ 72" x 72" x 30"	AX6PT187187/##	7322	8672
	90° Workstation Double plus layout 8 User Cable trays	8 @ 72" x 72" x 24"	AX8P186186/##	9510	10710
		8 @ 72" x 72" x 30"	AX8P187187/##	10202	12002

*All shared desking shows pricing per pod.

Please note:

Cable tray covers can be found on page 103

- Select finishes

Powdercoat frame

S

W

+

Laminate

300

8232

7981





8201

LPL

HPL

Axis 90° Workstations

With standard screens

Product	Description	Worktop	Code	LPL*	HPL*
	90° Workstation T layout 2 User Spine screens	2 @ 72" x 72" x 24"	AX2T18186/###	2583	2883
	Cable trays	2 @ 72" x 72" x 30"	AX2T181875/###	2785	3235
	90° Workstation Plus layout 4 User Spine screens	4 @ 72" x 72" x 24"	AX4P18186/###	6548	7148
	Cable trays	4 @ 72" x 72" x 30"	AX4P181875/###	6910	7810
	90° Workstation H layout 4 User Spine screens	4 @ 72" x 72" x 24"	AX4H18186/###	4925	5525
	Cable trays	4 @ 72" x 72" x 30"	AX4H181875/###	5296	6196
	90° Workstation 6 User Spine screens	6 @ 72" x 72" x 24"	AX6PT18186/###	8877	9777
	Cable trays	6 @ 72" x 72" x 30"	AX6PT181875/###	9421	10771
	90° Workstation Double plus layout 8 User Spine screens	8 @ 72" x 72" x 24"	AX8P18186/###	12838	14038
	Cable trays	8 @ 72" x 72" x 30"	AX8P181875/###	13547	15347

*All shared desking shows pricing per pod.

Please note:

Comseal covers can be found on page 102

- Select finishes

Powdercoat frame (desk)



+

Laminate

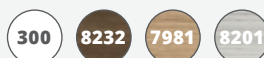

+

Screen insert



← e-Panel → PVC

Axis 90° Workstations

With Devise screens

Product	Description	Worktop	Code	LPL*	HPL*
	90° Workstation T layout 2 User Spine screens	2 @ 72" x 72" x 24"	AX2T18186/###	2930	3230
	Cable trays	2 @ 72" x 72" x 30"	AX2T187187/###	3148	3598
	90° Workstation Plus layout 4 User Spine screens	4 @ 72" x 72" x 24"	AX4P186186/###	7417	8017
	Cable trays	4 @ 72" x 72" x 30"	AX4P187187/###	7805	8705
	90° Workstation H layout 4 User Spine screens	4 @ 72" x 72" x 24"	AX4H186186/###	5591	6191
	Cable trays	4 @ 72" x 72" x 30"	AX4H187187/###	5988	6888
	90° Workstation 6 User Spine screens	6 @ 72" x 72" x 24"	AX6PT186186/###	10063	10963
	Cable trays	6 @ 72" x 72" x 30"	AX6PT187187/###	10645	11995
	90° Workstation Double plus layout 8 User Spine screens	8 @ 72" x 72" x 24"	AX8P186186/###	14545	15745
	Cable trays	8 @ 72" x 72" x 30"	AX8P187187/###	15301	17101

*All shared desking shows pricing per pod.

Please note:

Eclipse tray covers can be found on page 69

- Select finishes

Powdercoat frame (desk)



+ Laminate

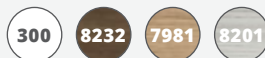

+ E-Panel Color



LPL ————— HPL

Axis 120° Workstations

Product	Description	Worktop	Code	LPL*	HPL*
	120° Workstation 3 User Cable trays	3 @ 48" x 48" x 24"	AX3SW12126/##	3761	4043
	120° Workstation 6 User Cable trays	6 @ 48" x 48" x 24"	AX6SW12126/##	7521	8086
	120° Workstation 9 User Cable trays	9 @ 48" x 48" x 24"	AX9SW12126/##	11281	12129
	120° Workstation 12 User Cable trays	12 @ 48" x 48" x 24"	AX12SW12126/##	15041	16171
	120° Workstation 18 User Cable trays	18 @ 48" x 48" x 24"	AX18SW12126/##	22561	24257

*All shared desking shows pricing per pod.

Please note:

Cable tray covers can be found on page 103

- Select finishes

Powdercoat frame



+ **Laminate**

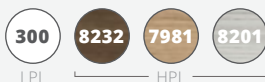

Axis 120° Workstations

With standard screens

Product	Description	Worktop	Code	LPL*	HPL*
	120° Workstation 3 User Spine screens Cable trays	3 @ 48" x 48" x 24"	AX3SW12126/###	4546	5080
	120° Workstation 6 User Spine screens Cable trays	6 @ 48" x 48" x 24"	AX6SW12126/###	9092	10160
	120° Workstation 9 User Spine screens Cable trays	9 @ 48" x 48" x 24"	AX9SW12126/###	13638	16158
	120° Workstation 12 User Spine screens Cable trays	12 @ 48" x 48" x 24"	AX12SW12126/###	18183	21543
	120° Workstation 18 User Spine screens Cable trays	18 @ 48" x 48" x 24"	AX18SW12126/###	27275	32315

*All shared desking shows pricing per pod.

Please note:

Comseal covers can be found on page 102

- Select finishes

Powdercoat frame (desk) S W + **Laminate** 300 8232 7981 8201 + **Screen insert** I B T

LPL HPL e-Panel PVC

Axis 120° Workstations

With Devise screens

Product	Description	Worktop	Code	LPL*	HPL*
	120° Workstation 3 User Spine screens Cable trays	3 @ 48" x 48" x 24"	AX3SW12126/###	5114	5715
	120° Workstation 6 User Spine screens Cable trays	6 @ 48" x 48" x 24"	AX6SW12126/###	10228	11430
	120° Workstation 9 User Spine screens Cable trays	9 @ 48" x 48" x 24"	AX9SW12126/###	15342	17144
	120° Workstation 12 User Spine screens Cable trays	12 @ 48" x 48" x 24"	AX12SW12126/###	20456	22860
	120° Workstation 18 User Spine screens Cable trays	18 @ 48" x 48" x 24"	AX18SW12126/###	30684	34289

*All shared desking shows pricing per pod.

Please note:

Eclipse tray covers can be found on page 69

- Select finishes

Powdercoat frame (desk)



+

Laminate



+

E-Panel Color



LPL

HPL

Axis Desk Hung Screens

Product	Description	Dimensions	Code	USD
	Desk hung screen	48" x 36" high	AXHS12OFF/#	505
		60" x 36" high	AXHS15OFF/#	657
		72" x 36" high	AXHS18OFF/#	696
		48" x 36" high	AXHS12/#	475
		60" x 36" high	AXHS15/#	626
		72" x 36" high	AXHS18/#	665

Please note:

Offset Bracket code (OFF) is for screens used on single sided Axis Straightline workstations.

- Select screen insert

E-panel



OR Translucent



Axis Desk Hung Screens

Product	Description	Dimensions	Code	USD
	Desk hung screen	48" x 36" high	DHS48OFF/#	688
		60" x 36" high	DHS60OFF/#	555
		72" x 36" high	DHS72OFF/#	765
		48" x 36" high	DHS48/#	522
		60" x 36" high	DHS60/#	731
		72" x 36" high	DHS72/#	722

Please note:



Offset Bracket code (OFF) is for screens used on single sided Axis Straightline workstations.

- Select Screen Colour



E-panel



Standard Return Screens

Product	Description	Dimensions	Code	USD
	Return screen Single sided desks	23" x 20" high	AXSRS58/#	179
		29" x 20" high	AXSRS73/#	196
	Return screen Double sided desks	26" x 20" high	AXRS65/#	165
		32" x 20" high	AXRS80/#	194
	Return screen Double sided desks end of run	26" x 20" high	AXRS65/#_E	181
		32" x 20" high	AXRS80/#_E	213

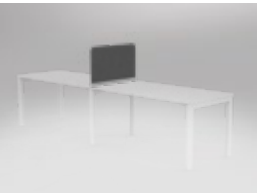
Devise Return Screens

Product	Description	Dimensions	Code	USD
	Return screen Single and double sided desks	23" x 12" high	DRS5931/#	159
		29" x 12" high	DRS7431/#	187
	Return screen Single and double sided desks	23" x 18" high	DRS5946/#	193
		29" x 18" high	DRS7446/#	225

- Select Standard Screen Insert

E-panel



OR

Translucent







- Select Devise Screen Colour

E-panel



Axis Electrical

Product	Description	Dimensions	Code	USD
	Axis Voltra power module 3 outlets, 2 USB-A ports 108" cord <i>*Works on Axis/Anvil desking only</i>		AXPM3O2U-W-108	219
	One Duplex For one duplex in tray		ELECTRICAL_1	188
	Two Duplex For two duplexes in tray		ELECTRICAL_2	343
	Base Infeed Hardwire	Standard - 72"	EHINFD-72	207
		NYC - 72"	EHNYCINFD-72	207
	Ceiling Infeed Hardwire	Standard - 144"	EHINFD-144	249
		NYC - 144"	EHNYCINFD-144	249

Accessories

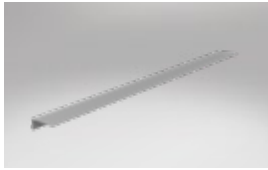
Product	Description	Dimensions	Code	USD
	Eclipse Tray Tidy Flexible PVC tray cover	48"	ECTT48	74
		60"	ECTT60	94
		72"	ECTT72	111

Please note:

- All electrical prices include all required jumper cables, connecting hardware, duplexes, electrical face plate, and data face plate with four knockouts
- Single-sided desks can only have below desk electrical, and double sided desks can only have above desk electrical.

Anvil Desking

Frames:

Arctic White Powdercoat finish to frame
 2 x 2 x 2" triangle legs
 2 x 1" rails
 28.75" Worksurface height

Worksurfaces:

1" M2 Grade substrate
 Studio White Melamine finish
 Matching 2mm PVC edge
 90° worksurface comes as with join at 47" along the left or right hand side
 Double sided desks include comseal covers

Spine Screens:

Translucent or E-panel insert to top 11.82"
 White Melamine below
 0.82" thickness
 Sits 19.7" above desk height
 All brackets & trims included
 E-panel is available in Ignite Red or Black and has a tackable core

Desk

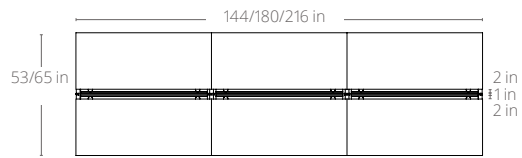
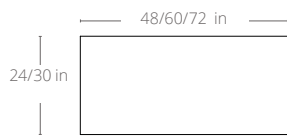

90° Workstation

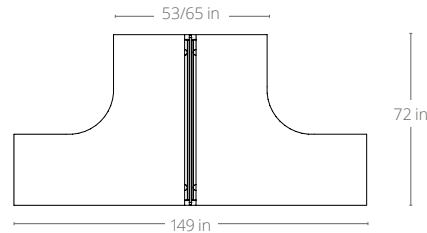
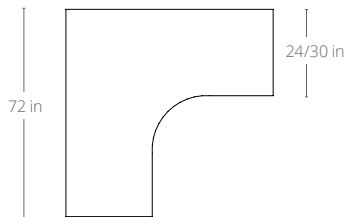

120° Workstation

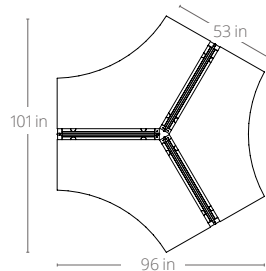
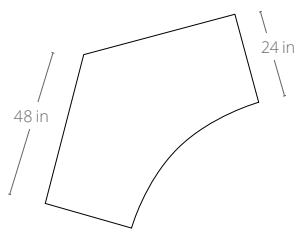

Desk & Return

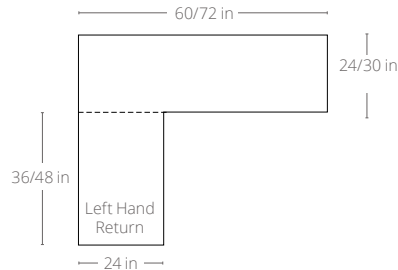

Standard Dividers

Spine Screens

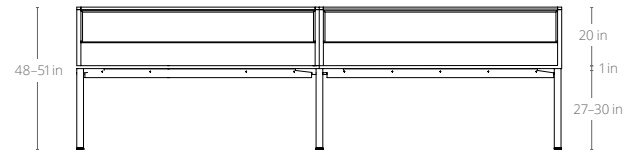
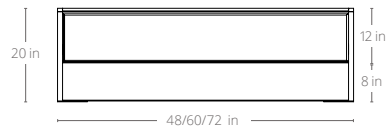

Desk Hung Screens

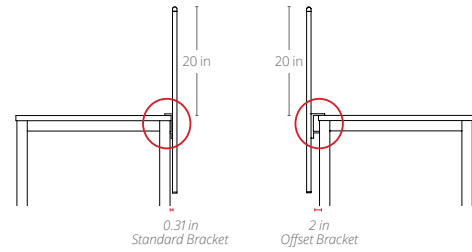
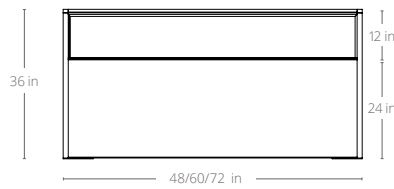

Return Screens

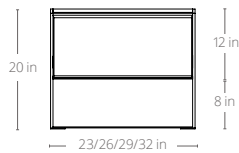

Devise Dividers

Spine Screens

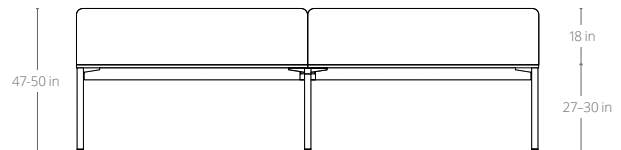
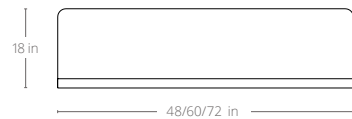

Desk Hung Screens

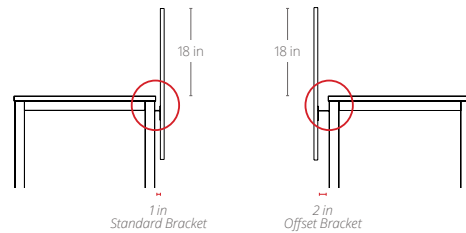



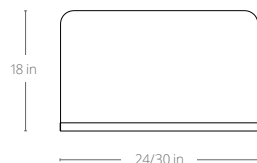

Return Screens

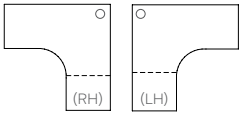

* All dimensions are nominal

Anvil Desking

Product	Description	Worktop	Code	LPL	HPL
	Desk Fixed height	48" x 24"	ANSD126/W#	631	699
		48" x 30"	ANSD1275/W#	746	837
		60" x 24"	ANSD156/W#	682	771
		60" x 30"	ANSD1575/W#	807	915
		72" x 24"	ANSD186/W#	730	812
		72" x 30"	ANSD1875/W#	860	994
		72" x 36" <i>Includes 6" conference front</i>	ANSD1890/W#	865	1034
	90° Workstation Fixed height	72" x 72"/24"	AN9W18186/WL#	1140	
		72" x 72"/24"	AN9W18186/WR#	1140	
		72" x 72"/30"	AN9W181875/WL#	1260	
		72" x 72"/30"	AN9W181875/WR#	1260	
					
	120° Workstation Fixed height	48" x 48"/24"	AN12W12126/W#	1150	1430
	Upgrade Modesty panel Laminate	42.5" wide x 12" deep	AXM12/#	87	113
		54.5" wide x 12" deep	AXM15/#	90	117
		66.25" wide x 12" deep	AXM18/#	104	135



- Select Worksurface Finish

Worksurface

300
8232
7981
3201

LPL
HPL

Anvil Desk & Return



Product	Description	Worktop	Code	LPL	HPL
 <p>Left hand return Fixed height</p>		60" x 24"/36" x 24"	ANDR156156/WL#	940	978
		60" x 30"/36" x 24" <i>Includes 6" conference front</i>	ANDR1575176/WL#	1470	1377
		60" x 24"/48" x 24"	ANDR156186/WL#	998	1062
		60" x 30"/48" x 24" <i>Includes 6" conference front</i>	ANDR1575206/WL#	1534	1470
		72" x 24"/36" x 24"	ANDR186156/WL#	989	1019
		72" x 30"/36" x 24" <i>Includes 6" conference front</i>	ANDR1875176/WL#	1523	1458
		72" x 24"/48" x 24"	ANDR186186/WL#	1045	1105
		72" x 30"/48" x 24" <i>Includes 6" conference front</i>	ANDR1875206/WL#	1586	1550
 <p>Right hand return Fixed height</p>		60" x 24"/36" x 24"	ANDR156156/WR#	940	978
		60" x 30"/36" x 24" <i>Includes 6" conference front</i>	ANDR1575176/WR#	1470	1377
		60" x 24"/48" x 24"	ANDR156186/WR#	998	1062
		60" x 30"/48" x 24" <i>Includes 6" conference front</i>	ANDR1575206/WR#	1534	1470
		72" x 24"/36" x 24"	ANDR186156/WR#	989	1019
		72" x 30"/36" x 24" <i>Includes 6" conference front</i>	ANDR1875176/WR#	1523	1458
		72" x 24"/48" x 24"	ANDR186186/WR#	1045	1105
		72" x 30"/48" x 24" <i>Includes 6" conference front</i>	ANDR1875206/WR#	1586	1550
 <p>Upgrade Modesty panel Laminate</p>		42.5" wide x 12" deep	AXM12/#	87	113
		54.5" wide x 12" deep	AXM15/#	90	117
		66.25" wide x 12" deep	AXM18/#	104	135

- Select Worksurface Finish

Worksurface

300	8232	7981	8201
LPL	HPL		

Anvil Shared Desking

Product	Description	Worktop	Code	LPL*	HPL*
	Desk Single sided 2 User	2 @ 48" x 24"	AN2SSD126/W#	1044	1180
		2 @ 48" x 30"	AN2SSD1275/W#	1220	1402
		2 @ 60" x 24"	AN2SSD156/W#	1143	1321
		2 @ 60" x 30"	AN2SSD1575/W#	1348	1564
		2 @ 72" x 24"	AN2SSD186/W#	1240	1404
		2 @ 72" x 30"	AN2SSD1875/W#	1452	1720
	Desk Single sided 3 User	3 @ 48" x 24"	AN3SSD126/W#	1457	1661
		3 @ 48" x 30"	AN3SSD1275/W#	1696	1969
		3 @ 60" x 24"	AN3SSD156/W#	1606	1873
		3 @ 60" x 30"	AN3SSD1575/W#	1879	2203
		3 @ 72" x 24"	AN3SSD186/W#	1752	1998
		3 @ 72" x 30"	AN3SSD1875/W#	2040	2442
	Upgrade Modesty panel Laminate	42.5" wide x 12" deep	AXM12/#	87	113
		54.5" wide x 12" deep	AXM15/#	90	117
		66.25" wide x 12" deep	AXM18/#	104	135

*All shared desking shows pricing per pod.

Please note:



Single sided desk cable management can be found on page 102

- Select Worksurface Finish

Worksurface 300 8232 7981 3201

LPL HPL

Anwil Shared Desking

Product	Description	Worktop	Code	LPL*	HPL*
	Desk Double sided 2 User Cable trays	2 @ 48" x 24"	AN2DSD126/W#	1317	1453
		2 @ 48" x 30"	AN2DSD1275/W#	1491	1673
		2 @ 60" x 24"	AN2DSD156/W#	1458	1636
		2 @ 60" x 30"	AN2DSD1575/W#	1640	1856
		2 @ 72" x 24"	AN2DSD186/W#	1725	1889
		2 @ 72" x 30"	AN2DSD1875/W#	1783	2051
	Desk Double sided 4 User Cable trays	4 @ 48" x 24"	AN4DSD126/W#	2203	2475
		4 @ 48" x 30"	AN4DSD1275/W#	2489	2853
		4 @ 60" x 24"	AN4DSD156/W#	2548	3139
		4 @ 60" x 30"	AN4DSD1575/W#	2778	3210
		4 @ 72" x 24"	AN4DSD186/W#	2803	3131
		4 @ 72" x 30"	AN4DSD1875/W#	3072	3608
	Desk Double sided 6 User Cable trays	6 @ 48" x 24"	AN6DSD126/W#	3118	3526
		6 @ 48" x 30"	AN6DSD1275/W#	3466	4012
		6 @ 60" x 24"	AN6DSD156/W#	3534	4068
		6 @ 60" x 30"	AN6DSD1575/W#	3925	4573
		6 @ 72" x 24"	AN6DSD186/W#	3950	4442
		6 @ 72" x 30"	AN6DSD1875/W#	4372	5176

*All shared desking shows pricing per pod.

Please note:

Cable tray covers can be found on page 103



- Select Worksurface Finish

Worksurface

300	8232	7981	3201
LPL	HPL		

Anvil Shared Desking

With standard screens

Product	Description	Worktop	Code	LPL*	HPL*
 <p>Desk Double sided 2 User Cable trays Spine screens</p>		2 @ 48" x 24"	AN2DSD126/W##	1468	1861
		2 @ 48" x 30"	AN2DSD1275/W##	1565	2048
		2 @ 60" x 24"	AN2DSD156/W##	1692	2141
		2 @ 60" x 30"	AN2DSD1575/W##	1812	2376
		2 @ 72" x 24"	AN2DSD186/W##	1882	2334
		2 @ 72" x 30"	AN2DSD1875/W##	2017	2643
 <p>Desk Double sided 4 User Cable trays Spine screens</p>		4 @ 48" x 24"	AN4DSD126/W##	3081	3353
		4 @ 48" x 30"	AN4DSD1275/W##	3325	3689
		4 @ 60" x 24"	AN4DSD156/W##	3557	3913
		4 @ 60" x 30"	AN4DSD1575/W##	3847	4279
		4 @ 72" x 24"	AN4DSD186/W##	4008	4336
		4 @ 72" x 30"	AN4DSD1875/W##	4277	4813
 <p>Desk Double sided 6 User Cable trays Spine screens</p>		6 @ 48" x 24"	AN6DSD126/W##	4391	4799
		6 @ 48" x 30"	AN6DSD1275/W##	4708	5254
		6 @ 60" x 24"	AN6DSD156/W##	5155	5689
		6 @ 60" x 30"	AN6DSD1575/W##	5099	5747
		6 @ 72" x 24"	AN6DSD186/W##	5770	6262
		6 @ 72" x 30"	AN6DSD1875/W##	6186	6990

*All shared desking shows pricing per pod.

Please note:

Comseal covers can be found on page 102

- Select finishes

Worksurface



300
8232
7981
8201
+
Screen insert

I
B
T

LPL HPL
e-Panel
PVC

Anvil Shared Desking

With Devise screens

Product	Description	Worktop	Code	LPL*	HPL*
	Desk Double sided 2 User Cable trays Spine screens	2 @ 48" x 24"	AN2DSD126/W##	1940	2076
		2 @ 48" x 30"	AN2DSD1275/W##	2098	2280
		2 @ 60" x 24"	AN2DSD156/W##	2208	2386
		2 @ 60" x 30"	AN2DSD1575/W##	2429	2645
		2 @ 72" x 24"	AN2DSD186/W##	2441	2605
		2 @ 72" x 30"	AN2DSD1875/W##	2671	2939
	Desk Double sided 4 User Cable trays Spine screens	4 @ 48" x 24"	AN4DSD126/W##	3466	3738
		4 @ 48" x 30"	AN4DSD1275/W##	3740	4104
		4 @ 60" x 24"	AN4DSD156/W##	4001	4357
		4 @ 60" x 30"	AN4DSD1575/W##	4327	4759
		4 @ 72" x 24"	AN4DSD186/W##	4509	4837
		4 @ 72" x 30"	AN4DSD1875/W##	4811	5347
	Desk Double sided 6 User Cable trays Spine screens	6 @ 48" x 24"	AN6DSD126/W##	4940	5348
		6 @ 48" x 30"	AN6DSD1275/W##	5296	5842
		6 @ 60" x 24"	AN6DSD156/W##	5799	6333
		6 @ 60" x 30"	AN6DSD1575/W##	5735	6383
		6 @ 72" x 24"	AN6DSD186/W##	6490	6982
		6 @ 72" x 30"	AN6DSD1875/W##	6959	7763

*All shared desking shows pricing per pod.

Please note:
Eclipse tray covers can be found on page 87

- Select finishes







Worksurface

300
8232
7981
8201
+
E-Panel Color

DBL
DCH
DGR

LPL
HPL

Anvil 90° Workstations

Product	Description	Worktop	Code	LPL*	HPL*
	90° Workstation 2 User	2 @ 72" x 72" x 24"	AN2U186186/W#	1873	2173
		2 @ 72" x 72" x 30"	AN2U187187/W#	2110	2560
	90° Workstation T layout 2 User Cable trays	2 @ 72" x 72" x 24"	AN2T186186/W#	2322	2622
		2 @ 72" x 72" x 30"	AN2T187187/W#	2596	3046
	90° Workstation Plus layout 4 User Cable trays	4 @ 72" x 72" x 24"	AN4P186186/W#	4991	5591
		4 @ 72" x 72" x 30"	AN4P187187/W#	5548	6448
	90° Workstation H layout 4 User Cable trays	4 @ 72" x 72" x 24"	AN4H186186/W#	4225	4825
		4 @ 72" x 72" x 30"	AN4H187187/W#	4691	5591
	90° Workstation 6 User Cable trays	6 @ 72" x 72" x 24"	AN6PT186186/W#	6927	7827
		6 @ 72" x 72" x 30"	AN6PT187187/W#	7639	8989
	90° Workstation Double plus layout 8 User Cable trays	8 @ 72" x 72" x 24"	AN8P186186/W#	9634	10834
		8 @ 72" x 72" x 30"	AN8P187187/W#	10599	12399

*All shared desking shows pricing per pod.

Please note:

Cable tray covers can be found on page 103

- Select Worksurface Finish

Worksurface

300

8232

7981





8201

LPL

HPL

Anvil 90° Workstations

With standard screens

Product	Description	Worktop	Code	LPL*	HPL*
	90° Workstation T layout 2 User Spine screens Cable trays	2 @ 72" x 72" x 24"	AN2T186186/W##	2870	3170
		2 @ 72" x 72" x 30"	AN2T187187/W##	3207	3657
	90° Workstation Plus layout 4 User Spine screens Cable trays	4 @ 72" x 72" x 24"	AN4P186186/W##	7280	7880
		4 @ 72" x 72" x 30"	AN4P187187/W##	7958	8858
	90° Workstation H layout 4 User Spine screens Cable trays	4 @ 72" x 72" x 24"	AN4H186186/W##	5090	5690
		4 @ 72" x 72" x 30"	AN4H187187/W##	5552	6452
	90° Workstation 6 User Spine screens Cable trays	6 @ 72" x 72" x 24"	AN6PT186186/W##	12355	13255
		6 @ 72" x 72" x 30"	AN6PT187187/W##	13110	14460
	90° Workstation Double plus layout 8 User Spine screens Cable trays	8 @ 72" x 72" x 24"	AN8P186186/W##	14527	15727
		8 @ 72" x 72" x 30"	AN8P187187/W##	15443	17243

*All shared desking shows pricing per pod.

Please note:

Comseal covers can be found on page 102

- Select finishes

Worksurface

300
8232
7981
8201
+
Screen insert

I
B
T

LPL
HPL
e-Panel
PVC

Anvil 90° Workstations

With Devise screens

Product	Description	Worktop	Code	LPL*	HPL*
	90° Workstation T layout 2 User Spine screens	2 @ 72" x 72" x 24"	AN2T186186/W##	3254	3554
	Cable trays	2 @ 72" x 72" x 30"	AN2T187187/W##	3623	4073
	90° Workstation Plus layout 4 User Spine screens	4 @ 72" x 72" x 24"	AN4P186186/W##	8241	8841
	Cable trays	4 @ 72" x 72" x 30"	AN4P187187/W##	8982	9882
	90° Workstation H layout 4 User Spine screens	4 @ 72" x 72" x 24"	AN4H186186/W##	5778	6378
	Cable trays	4 @ 72" x 72" x 30"	AN4H187187/W##	6277	7177
	90° Workstation 6 User Spine screens	6 @ 72" x 72" x 24"	AN6PT186186/W##	13976	14876
	Cable trays	6 @ 72" x 72" x 30"	AN6PT187187/W##	14794	16144
	90° Workstation Double plus layout 8 User Spine screens	8 @ 72" x 72" x 24"	AN8P186186/W##	16445	17645
	Cable trays	8 @ 72" x 72" x 30"	AN8P187187/W##	17435	19235

*All shared desking shows pricing per pod.

Please note:

Eclipse tray covers can be found on page 87

- Select finishes

Worksurface **300** **8232** **7981** **8201** + E-Panel Color **DBL** **DCH** **DGR**

LPL ————— HPL

Anvil 120° Workstations

Product	Description	Worktop	Code	LPL*	HPL*
	120° Workstation 3 User Cable trays	3 @ 48" x 48" x 24"	AN3SW12126/W#	3754	4594
	120° Workstation 6 User Cable trays	6 @ 48" x 48" x 24"	AN6SW12126/W#	7508	9188
	120° Workstation 9 User Cable trays	9 @ 48" x 48" x 24"	AN9SW12126/W#	11262	13782
	120° Workstation 12 User Cable trays	12 @ 48" x 48" x 24"	AN12SW12126/W#	15016	18376
	120° Workstation 18 User Cable trays	18 @ 48" x 48" x 24"	AN18SW12126/W#	22524	27564

*All shared desking shows pricing per pod.

Please note:

Cable tray covers can be found on page 103





- Select Worksurface Finish

Worksurface 300 8232 7981 8201

LPL HPL

Anvil 120° Workstations

With standard screens

Product	Description	Worktop	Code	LPL*	HPL*
	120° Workstation 3 User Cable trays Comseal covers Spine screens	3 @ 48" x 48" x 24"	AN3SW12126/W##	4642	5482
	120° Workstation 6 User Cable trays Comseal covers Spine screens	6 @ 48" x 48" x 24"	AN6SW12126/W##	9284	10964
	120° Workstation 9 User Cable trays Comseal covers Spine screens	9 @ 48" x 48" x 24"	AN9SW12126/W##	13926	16446
	120° Workstation 12 User Cable trays Comseal covers Spine screens	12 @ 48" x 48" x 24"	AN12SW12126/W##	18568	21928
	120° Workstation 18 User Cable trays Comseal covers Spine screens	18 @ 48" x 48" x 24"	AN18SW12126/W##	27852	32892

*All shared desking shows pricing per pod.

Please note:

Comseal covers can be found on page 102

- Select finishes

Worksurface
300
8232
7981
8201
+
Screen insert
I
B
T

LPL
HPL
e-Panel
PVC

Anvil 120° Workstations

With Devise screens

Product	Description	Worktop	Code	LPL*	HPL*
	120° Workstation 3 User Cable trays Spine screens	3 @ 48" x 48" x 24"	AN3SW12126/W##	5222	6062
	120° Workstation 6 User Cable trays Spine screens	6 @ 48" x 48" x 24"	AN6SW12126/W##	10445	12125
	120° Workstation 9 User Cable trays Spine screens	9 @ 48" x 48" x 24"	AN9SW12126/W##	15666	18186
	120° Workstation 12 User Cable trays Spine screens	12 @ 48" x 48" x 24"	AN12SW12126/W##	20889	24249
	120° Workstation 18 User Cable trays Spine screens	18 @ 48" x 48" x 24"	AN18SW12126/W##	31333	36373

*All shared desking shows pricing per pod.

Please note:

Eclipse tray covers can be found on page 87

- Select finishes

Worksurface 300 8232 7981 8201 + **E-Panel Color** DBL DCH DGR

LPL HPL

Standard Desk Hung Screens

Product	Description	Dimensions	Code	USD
	Offset* desk hung screen	48" x 36" high	AXHS12OFF/#	505
		60" x 36" high	AXHS15OFF/#	657
		72" x 36" high	AXHS18OFF/#	696
	Standard desk hung screen	48" x 36" high	AXHS12/#	475
		60" x 36" high	AXHS15/#	626
		72" x 36" high	AXHS18/#	665

Please note:

Offset Bracket code (OFF) is for screens used on single sided Anvil Straightline workstations.

- Select screen insert

E-panel



OR

Translucent



Devise Desk Hung Screens

Product	Description	Dimensions	Code	USD
	Desk hung screen	48" x 36" high	DHS48OFF/#	688
		60" x 36" high	DHS60OFF/#	555
		72" x 36" high	DHS72OFF/#	765
		48" x 36" high	DHS48/#	522
		60" x 36" high	DHS60/#	731
		72" x 36" high	DHS72/#	722

Please note:

Offset Bracket code (OFF) is for screens used on single sided Anvil Straightline workstations.

- Select Screen Colour



E-panel



Standard Return Screens

Product	Description	Dimensions	Code	USD
	Return Screen Single sided desks	23" x 20" high	AXSRS58/#	168
		29" x 20" high	AXSRS73/#	196
	Return Screen Double sided desks	26" x 20" high	AXRS65/#	165
		32" x 20" high	AXRS80/#	194
	Return Screen Double sided desks end of run	26" x 20" high	AXRS65/#_E	181
		32" x 20" high	AXRS80/#_E	213

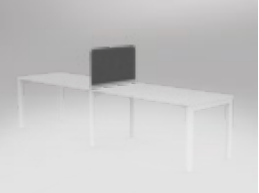
Devise Return Screens

Product	Description	Dimensions	Code	USD
	Return screen Single and double sided desks	23" x 12" high	DRS5931/#	159
		29" x 12" high	DRS7431/#	187
	Return screen Single and double sided desks	23" x 18" high	DRS5946/#	193
		29" x 18" high	DRS7446/#	225

- Select Standard screen insert

E-panel



OR

Translucent







- Select Devise Screen Colour

E-panel



Anvil Electrical

Product	Description	Dimensions	Code	USD
	Axis Voltra power module 3 outlets, 2 USB-A ports 108" cord <i>*Works on Axis/Anvil desking only</i>		AXPM3O2U-W-108	219
	One Duplex For one duplex in tray		ELECTRICAL_1	188
	Two Duplex For two duplexes in tray		ELECTRICAL_2	343
	Base Infeed Hardwire	Standard - 72"	EHINFD-72	207
		NYC - 72"	EHNYCINFD-72	207
	Ceiling Infeed Hardwire	Standard - 144"	EHINFD-144	249
		NYC - 144"	EHNYCINFD-144	249

Accessories

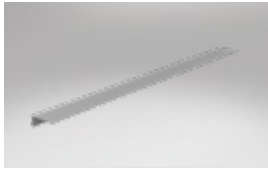
Product	Description	Dimensions	Code	USD
	Eclipse Tray Tidy Flexible PVC tray cover	48"	ECTT48	74
		60"	ECTT60	94
		72"	ECTT72	111

Please note:

- All electrical prices include all required jumper cables, connecting hardware, duplexes, electrical face plate, and data face plate with four knockouts
- Single-sided desks can only have below desk electrical, and double sided desks can only have above desk electrical.





Receptions & Storage

Reception Counters	92
Mobiles	93
Caddy Mobiles	94
Storage Towers	95
Overhead Storage	95
Storage.....	96
Worktops.....	97

Reception Counters

Product	Description	Dimensions	Code	USD
	Axis reception Pop-top Fits over desk - AXSD1875/# - AX9W181875/#	72.5" wide x 42" high x 12" deep	AXRPD183/W	875
	Axis reception corner Pop-top Fits over workstation - AX9W181875/#	72.5" x 75" x 42" high x 12" deep <i>Can be left hand or right hand</i>	AXRPW18183/W	1616
	Axis reception Fits over desk - AXSD1875/# - AX9W181875/#	72.5" wide x 38.5" high x 12" deep	AXRD183/W	625
	Axis reception corner Fits over workstation - AX9W181875/#	72.5" x 75" x 38.5" high x 12" deep <i>Can be left hand or right hand</i>	AXRW18183/W	1144
	Anvil reception - White Fits over desk - AXSD1875/#	73"-96" wide x 37" deep x 42" high	ANRC/WW	2056
	Anvil reception - Silver Fits over desk - AXSD1875/#	73"-96" wide x 37" deep x 42" high	ANRC/WS	2056
	Anvil Facade Upgrade	38.5" wide x 15" deep x 42" high	ANRFD/#	656

Please note:





Reception units require the desk to be ordered separately.

- Select Facade Upgrade Finish

Worksurface



Mobiles

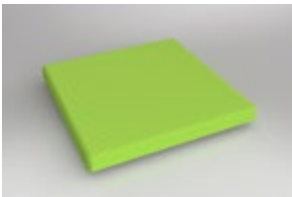
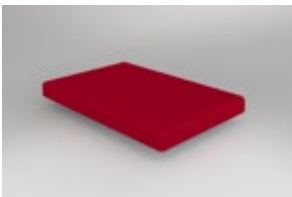





Product	Description	Dimensions	Code	USD
	Mobile BBF - White Two box drawers One file drawer Gang locking	25.2"H x 16.0"W x 18.6"D	AXM2F/W	614
	Mobile BBF - Black Two box drawers One file drawer Gang locking	25.2"H x 16.0"W x 18.6"D	AXM2F/B	614
	Mobile BF - White One box drawer One file drawer Gang locking	20.5"H x 12.0"W x 18.6"D	AXM1F/W	481
	Mobile BF - Black One box drawer One file drawer Gang locking	20.5"H x 12.0"W x 18.6"D	AXM1F/B	481
	Toppa pad - large Breathe Upholstery	1.0"H x 16.0"W x 18.6"D <i>Does not fit BF mobile pedestal</i>	AXMTOPPA/#	70
	Toppa pad - small Breathe Upholstery	1.0"H x 12.0"W x 18.6"D <i>Does not fit BBF mobile pedestal</i>	AXBFTOPPA-US/#	70

- Select fabric - Toppa pad

Breathe



Caddy Mobiles



Product	Description	Dimensions	Code	USD
	Bookcases	25.2"H x 34.5"W x 18.1"D	AXCMB/W	492
	Bookcase & drawer	25.2"H x 34.5"W x 18.1"D <i>Can be left hand or right hand</i>	AXCM1/W	1027
	Drawers	25.2"H x 34.5"W x 18.1"D	AXCM2/W	1560
	Bookcase & tambour	25.2"H x 34.5"W x 18.1"D <i>Can be left hand or right hand</i>	AXCMT1/W	948
	Drawer & tambour	25.2"H x 34.5"W x 18.1"D <i>Can be left hand or right hand</i>	AXCMTD/W	1481
	Tambours	25.2"H x 34.5"W x 18.1"D	AXCMT2/W	1404
	Toppa pad Breathe Upholstery	1.0"H x 16.0"W x 18.6"D	AXMTOPPA/#	70

- Select fabric - Toppa pad

Breathe









Storage Towers

Product	Description	Dimensions	Code	USD
	Bookcase Adjustable shelves	49.2"H x 17.7"W x 18.5"D	AXBST12/W	518
	Bookcase & drawers Adjustable shelves	49.2"H x 17.7"W x 18.5"D	AXBSTD12/W	1052
	Bookcase & tambour Adjustable shelves	49.2"H x 17.7"W x 18.5"D	AXBSTT12/W	972







Overhead Storage

Product	Description	Dimensions	Code	USD
	Wall-mount hutch 4 locking doors	47.25" W x 16.9"H x 14"D	AX12WMH4D/W	812

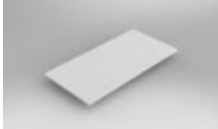
Storage

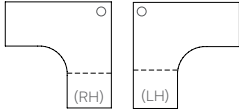
Product	Description	Dimensions	Code	USD
	Bookcase 3 Level	49.2"H x 35.4"W x 11.8"D	AXB12/W	617
	Cupboard 3 Level Locking	49.2"H x 35.4"W x 15.7"D	AXC12/W	836
	Credenza 2 Level Locking	35.4"H x 70.9"W x 15.7"D	AXCZ18/W	1175
	Lateral file 2 drawer Locking	28.7"H x 35.4"W x 23.6"D	AXLF2/W	1229
	Tambour 3 Level Locking	41.3"H x 35.4"W x 17.7"D	AXT12/W	1153
	Upgrade Tambour planter box <i>Plants not included</i>	7.9"H x 35.4"W x 17.7"D	AXPBOX/W	167
	Desk mount shelf 4 x chrome hoops	9.6"H x 23.6"W x 11.8"D	AXDSH6/W	169

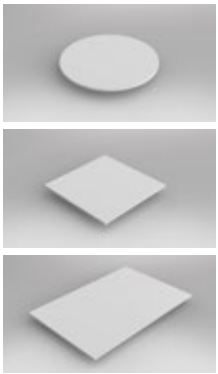
Worktops

Product	Description	Dimensions	Code	LPL	HPL
	Desk	36" x 24"	AXSD096/#_T	117	159
		48" x 24"	AXSD126/#_T	166	234
		48" x 30"	AXSD1275/#_T	199	290
		60" x 24"	AXSD156/#_T	202	291
		60" x 30"	AXSD1575/#_T	249	357
		72" x 24"	AXSD186/#_T	241	323
		72" x 30"	AXSD1875/#_T	292	426
		72" x 36"	AXSD189/#_T	295	464
	90° Workstation 	72" x 72"/24" (Right Hand Join)	AX9W18186/WR_T	509	
		72" x 72"/24" (Left Hand Join)	AX9W18186/WL_T	509	
		72" x 72"/30" (Right Hand Join)	AX9W181875/WR_T	547	
		72" x 72"/30" (Left Hand Join)	AX9W181875/WL_T	547	
	120° Workstation	48" x 48"/24"	AX12W12126/#_T	513	793
	Meeting table	36" diameter	AXT900R/#_T	174	235
		42" diameter	AXT105R/#_T	229	338
		60" diameter	AXT150R/#_T	489	659
		24" x 24"	AXSD066/#_T	90	107
		39" x 39"	AXT1010/#_T	213	371
		60" x 48"	AXT1512/#_T	405	594
		72" x 48"	AXT1812/#_T	423	623
		95" x 48"	AXT2412/#_T	528	843
	Meeting table With cutout for power modules	72" x 48"	AXT1812/#_T-1C	423	623
		96" x 48"	AXT2412/#_T-1C	528	843

- Select Worksurface Finish

Worksurface 300 8232 7981 8201



LPL HPL





Mobile Dividers

Orbit Divider

Product	Description	Dimensions	Code	USD
	Mobile Divider Whiteboard Locking casters	60" x 36"	ODM6036/WB	997
	Mobile Divider Pixel design Locking casters	60" x 36"	ODMPXL6036/GYW	1608

THIS PAGE IS INTENTIONALLY
LEFT BLANK









Accessories & Components

Cable Management.....	104
Cable Tray Covers.....	105
Accessories & Components.....	106
Monitor Arms.....	107
Viro Planter Wall.....	107

Cable Management

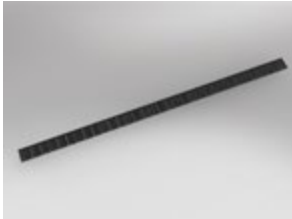
Product	Description	Dimensions	Code	USD
	Single-sided cable tray Power/data segregation Side fixing to Axis/Anvil horizontal support rail	42.5" Length	AXCTS11/#	114
		54.3" Length	AXCTS14/#	150
		66.1" Length	AXCTS17/#	179
	Single-sided cable tray Power/data segregation Top Lip Fixing	42.5" Length	AXCTT11/#	114
		54.3" Length	AXCTT14/#	150
		66.1" Length	AXCTT17/#	179
	Cable Cobra White Power/data segregation	42.5" Length	CABCOBRA/@	88
	Cable Clutch White Power/data segregation	Set of 5	CABCLUTCH_W	43
	Comseal cable tidy brushes	46.5" for 48" workstation	ANCS12/B	66
		58.5" for 60" workstation	ANCS15/B	83
		70.3" for 72" workstation	ANCS18/B	99

- Select finish



@ - Select finish



Cable Tray Covers

Product	Description	Dimensions	Code	LPL*	HPL*
	Cable tray covers	Fits 48" Desk with Twin Power	AXT450125/#	182	214
		Fits 60" Desk with Twin Power	AXT600125/#	188	230
		Fits 72" Desk with Twin Power	AXT750125/#	198	244
		Fits 48" Desk with Quad Power	AXT407125/#	182	216
		Fits 60" Desk with Quad Power	AXT557125/#	188	222
		Fits 72" Desk with Quad Power	AXT707125/#	198	242

*Pricing is shown per pair.

Please note:





All cable tray covers include necessary hardware.

- Select Worksurface Finish

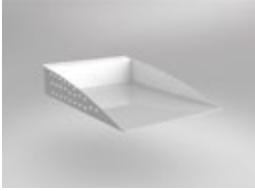

Worksurface 300 8232 7981 3201

LPL HPL



Accessories & Components

Product	Description	Dimensions	Code	USD
	Paper tray Rail hung White		AXA4TRAY/W	39
	Pen holder Rail hung White		AXPENTRAY/W	20
	Deskmount shelf brackets		AXDSHB/W	41
	E-panel screen brackets	A For double sided desk	ESCRCLAMPDS/W	49
		B For single sided desk	ESCRCLAMPT/W	40
		C For single sided desk	ESCRCLAMPSS/W	47
	Keys and locks	Axis system master key	AXKEY	8
		Axis system master key for barrel removal	AXKEYB	9
		Axis system keyed alike barrel and key	AXBARRELM	9
			AXBARRELC	18

Monitor Arms

Product	Description	Dimensions	Code	USD
	Fulcrum Dual Gas spring arms Grab Handle Black	Accommodates 17" - 32" screen	FCDMA/B	465
	Fulcrum Single Gas spring arms Desk mount Black	Accommodates 17" - 49" screen	FCSMA/B	300
	Single monitor arm Desk mount Black	Accommodates 13" - 27" screen	FWMA1/B	218

Planter Wall

Product	Description	Dimensions	Code	USD
	Viro Wall Frame only	78" x 40" x 8"	PLANTER/B	2148
	Pots		PLANTERPOT/B	32



General - 10 Year

Axis desking, side & conference tables, receptions, storage; Anvil desking, receptions, storage; Agile desking; Modulus training & conference tables; Uni training tables

All Workspace48 products are durable for long-term performance and value. Our products have been rigorously tested to the equivalent of 10 years average use, and our processes comply with internationally recognized certifications. We know the peace of mind a warranty like this can give when making a purchase. If you need to know any information about the legal terms of your warranty, you can find everything right here, or simply give one of our friendly account managers a call.

The 10 Year Warranty is valid on orders placed on or after January 1, 2020.

Warranty

Workspace48 promises the original purchaser that it will repair or replace with the comparable product, at its option and free of charge (for material and components) any product, part or component which fails under normal use over the duration of specified warranty term (taken from the date of purchase).

Normal commercial usage is defined as the equivalent of a single shift, 40-hour work week.

A Customer who requests services under this warranty must comply with directions from Workspace48 staff if the warranty claim is to be investigated, and if Workspace48 is to provide repairs and/or spare parts and/or replacement solutions (where applicable). The Customer will usually be required to provide a detailed description of the warranty service they are requesting, accompanied by any relevant photos or videos.

If the Customer does not comply with the directions aforementioned, Workspace48 is not required to provide services in accordance with this warranty. Without the description and images, Workspace48 can neither investigate the claim nor provide an appropriate solution.

Goods purchased from Workspace48 are covered by guarantees that cannot be excluded under Canadian Consumer Law. The Customer is entitled to a replacement or refund in a case of major fault.

Minor variations in dimensions, color, grain, or finish in Goods received by a Customer, when compared with images or descriptions on the Website, are not covered by this Warranty. The Warranty does not cover damage that affects only packaging.

Warranty Limitations

The particular product lines, materials and components listed below are covered according to the following schedule from the date of sale:

- Five Years - Electric motors, workstation electrical components

Warranty Exclusions

This warranty does not apply, and no other warranty applies to:

- Products that were not installed, used, or maintained in accordance with Workspace48 instructions
- Products that have been disassembled, modified, or rebuilt
- Normal wear and tear, which is to be expected over the course of ownership
- High-wear items such as glides and textiles
- Abuse, misuse, or accident
- Alteration or modification of the product including substitution of Workspace48 components with any unauthorized non-Workspace48 components
- Products considered consumables, Customer's Own Material (COM) or non-standard textiles and materials
- Variations occurring in surface materials (e.g., color-fastness or matching grains, textures, and colors across dissimilar lots)
- Products used for rental purposes

To the extent allowed by law, Workspace48 makes no other warranty, either express or implied, including any warranty of merchantability or fitness for a particular purpose. Workspace48 will not be liable for any consequential or incidental damages.



Seating - 10 Year

Adapta, Balance Executive, Balance Task, Balance Guest, Balance Training, Game, Metro, Mode, Otto, Politan

All Workspace48 products are durable for long-term performance and value. Our products have been rigorously tested to the equivalent of 10 years average use, and our processes comply with internationally recognized certifications. We know the peace of mind a warranty like this can give when making a purchase. If you need to know any information about the legal terms of your warranty, you can find everything right here, or simply give one of our friendly account managers a call.

The 10 Year Warranty is valid on orders placed on or after January 1, 2020.

Warranty

Workspace48 promises the original purchaser that it will repair or replace with the comparable product, at its option and free of charge (for material and components) any product, part or component which fails under normal use over the duration of specified warranty term (taken from the date of purchase).

Normal commercial usage is defined as the equivalent of a single shift, 40-hour work week.

A Customer who requests services under this warranty must comply with directions from Workspace48 staff if the warranty claim is to be investigated, and if Workspace48 is to provide repairs and/or spare parts and/or replacement solutions (where applicable). The Customer will usually be required to provide a detailed description of the warranty service they are requesting, accompanied by any relevant photos or videos.

If the Customer does not comply with the directions aforementioned, Workspace48 is not required to provide services in accordance with this warranty. Without the description and images, Workspace48 can neither investigate the claim nor provide an appropriate solution.

Goods purchased from Workspace48 are covered by guarantees that cannot be excluded under Canadian Consumer Law. The Customer is entitled to a replacement or refund in a case of major fault.

Minor variations in dimensions, color, grain, or finish in Goods received by a Customer, when compared with images or descriptions on the Website, are not covered by this Warranty. The Warranty does not cover damage that affects only packaging.

Warranty Limitations

The particular product lines, materials and components listed below are covered according to the following schedule from the date of sale:

- Five Years - Link and Luna chairs

Warranty Exclusions

This warranty does not apply, and no other warranty applies to:

- Products that were not installed, used, or maintained in accordance with Workspace48 instructions
- Products that have been disassembled, modified, or rebuilt
- Normal wear and tear, which is to be expected over the course of ownership
- High-wear items such as glides and textiles
- Abuse, misuse, or accident
- Alteration or modification of the product including substitution of Workspace48 components with any unauthorized non-Workspace48 components
- Products considered consumables, Customer's Own Material (COM) or non-standard textiles and materials
- Variations occurring in surface materials (e.g., color-fastness or matching grains, textures, and colors across dissimilar lots)
- Products used for rental purposes

To the extent allowed by law, Workspace48 makes no other warranty, either express or implied, including any warranty of merchantability or fitness for a particular purpose. Workspace48 will not be liable for any consequential or incidental damages.

Dealer Freight Schedule

ZONE 1 - Transit time: 1-3 days	ZONE 2 - Transit time: 2-3 days	ZONE 3 - Transit time: 3-5 days	ZONE 4 - Transit time: 3-6 days
<i>** Pricing tiers below shown in NET pricing</i>			
Minimum - \$145	Minimum - \$165	Minimum - \$185	Minimum - \$205
0\$ - \$5,000: 12% of NET	0\$ - \$5,000: 13% of NET	0\$ - \$5,000: 14% of NET	0\$ - \$5,000: 15% of NET
\$5,000 - \$10,000: 9% of NET	\$5,000 - \$10,000: 10% of NET	\$5,000 - \$10,000: 11% of NET	\$5,000 - \$10,000: 12% of NET
\$10,000 - \$30,000: 6% of NET	\$10,000 - \$30,000: 7% of NET	\$10,000 - \$30,000: 7% of NET	\$10,000 - \$30,000: 8% of NET
\$30,000 - \$100,000: 5% of NET	\$30,000 - \$100,000: 6% of NET	\$30,000 - \$100,000: 6% of NET	\$30,000 - \$100,000: 6% of NET
\$100,000+: 2% of NET	\$100,000+: 2% of NET	\$100,000+: 2% of NET	\$100,000+: 2% of NET

Connecticut	New York	Alabama	New Hampshire	Arizona	Utah	California
Delaware	Ohio	Georgia	North Carolina	Arkansas	Wyoming	Nevada
Illinois	Pennsylvania	Iowa	South Carolina	Colorado		Oregon
Indiana	Rhode Island	Kansas		Florida		Washington
Kentucky	Tennessee	Maine		Idaho		Montana
Maryland	Vermont	Minnesota		Louisiana		North Dakota
Massachusetts	Virginia	Mississippi		New Mexico		South Dakota
Michigan	West Virginia	Missouri		Oklahoma		
New Jersey	Wisconsin	Nebraska		Texas		
District Of Columbia						

- Price ranges are shown as NET prices
- Modulus conference tables may have an additional \$100 freight charge. Please request freight quote per order
- Freight structures are based only on stock draw projects; container projects are quoted separately
- Freight schedules are subject to change every six months
- Freight rates are applicable to carriers and transit times selected by WORKSPACE48. Special requests may result in additional charges
- Freight rates are to metropolitan areas; shipments to all other areas may had additional charges
- Freight rates are per shipment, not per order. If two shipments are required, two freight charges will be applied.
- Workspace48 does not arrange shipping to the USA for orders sold through Canadian dealers.

Terms & Conditions

1. These terms and conditions shall apply to all sales of goods by Workspace48 Inc. No variation of any of these conditions shall be binding unless expressly agreed to by Workspace48 Inc. in writing.
2. All prices are exclusive of GST/HST unless otherwise stated.
3. All orders under \$3,000 net will be subject to a \$33 NET packaging fee.
4. Payment in full shall be made to Workspace48 Inc. net 30 days on invoice. All orders over \$50,000 require a 35% deposit. Container payment terms are 30% deposit with order, 70% upon arrival of product. Workspace48 Inc. reserves the right to demand payment before that date or in advance and further reserves the right to specify in any quotation a requirement for a deposit to be paid before work shall commence. Interest shall be payable to Workspace48 Inc. on the Customer's overdue accounts at the rate of 18% per annum calculated on a daily basis to run from the due date for payment until receipt by Workspace48 Inc. of the full amount payable. The Customer shall pay all costs including any legal costs incurred in recovering overdue accounts.
5. We may suspend or terminate this agreement if at any time we consider the Customer's credit worthiness to be unsatisfactory for any reason or if the Customer is in default of any of its payment or other obligations hereunder. We shall not be responsible under any circumstances for any loss, damages, costs or expenses whatsoever caused in any way by the suspension or termination under this clause.
6. Goods returned for credit will only be accepted subject to Workspace48 Inc.'s prior agreement in writing with all freight charges prepaid by the Customer. Returned goods, if accepted by Workspace48 Inc., are subject to a minimum restocking fee of the greater of \$75 or 20% of the invoice price. Returned product will not be accepted if it has been removed from its original packaging and no credit will be issued for product returned damaged.
7. Prices are subject to variation without notice, and goods and services will be invoiced at prices current at the time of their provision unless otherwise agreed in writing.
8. Sales tax and any other taxes or duty on or in respect of the goods sold by Workspace48 Inc. imposed by any Provincial or Federal Government law shall be payable by the Customer, but if those taxes or duties by law are or become payable by Workspace48 Inc., the prices in respect of the goods shall be increased by the amount necessary to ensure that the net amount actually received by Workspace48 Inc. is as if those taxes or duties were not payable.

9. If the Customer is a limited liability company or a trust, then the director(s) and shareholder(s) of the company or the trustee(s) of the trust (as the case requires), hereby guarantee the performance of the Customer's obligations under this agreement and are personally liable to meet the Customer's obligations under this agreement in the event of the Customer's default. Those director(s) and shareholder(s) or trustee(s) also agree to indemnify Workspace48 Inc. and hold Workspace48 Inc. harmless for any losses Workspace48 Inc. sustains as a result of the Customer's act or omission. A director, shareholder or trustee (as the case requires) must reimburse Workspace48 Inc. for all its losses caused by the Customer's act or omission within 21 days of Workspace Inc. making a demand for such reimbursement (time being of the essence). Any director, shareholder or trustee signing this agreement on behalf of the Customer also signs in a personal capacity for the purposes of the guarantee and indemnity contained in this clause.
10. The Customer warrants that such plans, specifications, measurements or information that have been supplied by the Customer at the time of commencing work on purpose built furniture are correct and can be relied upon. Once work has started the Customer may not vary or withdraw from this or any other agreement with Workspace48 Inc. unless with Workspace48 Inc.'s agreement in writing.
11. All warranties conditions and representations whether express or implied other than any express warranty stated by Workspace48 Inc. in writing are hereby expressly negated and excluded except in circumstances where Workspace48 Inc. is by law unable to exclude or limit its liability. Provided that where the Customer is a consumer for the purpose of the Trade Practices Act, but the goods or services are not of a kind ordinarily required for personal domestic or household use or consumption, the liability of Workspace48 Inc. shall be limited as determined by Workspace48 Inc. to anyone or more of the following:
 - a. The replacement of the goods or the supply of equivalent goods
 - b. The payment of the costs of replacing the goods or of acquiring equivalent goods
12. No claim of any nature whatsoever (other than relating to warranty) will be recognised unless made within 24 hours of delivery. All freight costs involved in returning goods must be paid by the Customer. A copy of the invoice evidencing sale to the Customer is to be included with the goods, and include photo's to clearly identify the issue concerned.
13. Subject to everything in these conditions Workspace48 Inc. makes no further condition, warranty or representation, whether express or implied, written or oral in respect of the goods or services.
14. Notwithstanding anything above Workspace48 Inc. shall not be liable for any consequential or indirect losses expenses or damages suffered by the Customer in consequence of any defect in materials or workmanship of the goods.
15. Claims for errors, short supply, or for goods arriving in a damaged condition shall be made within seven (7) days of the date of invoice, and the Customer shall refuse to sign any deliver docket where goods arrive in a damaged condition. Workspace48 Inc. must be notified of the claim within 24 hours and assigned a file number by Workspace48 Inc. or the claim will not be accepted. The Customer is deemed to have accepted the goods unless it makes a claim under this clause. The Customer acknowledges that a signed delivery docket signifies acceptance that the goods arrived in an undamaged state and Workspace48 Inc. shall not be liable to repair any damage in such cases. The Customer is responsible to file any claim resulting from Customers' carrier.
16. Risk in goods supplied under this agreement passes to the Customer upon delivery to the Customer or its agent or upon possession of the goods by the Customer or its agent, whichever is the earlier.
17. Workspace48 Inc. shall not be liable in any way whatsoever for any failure to deliver any order on time or for non-delivery or delay caused directly or indirectly by war, act of God, strike, lockout, riot, Government action or interference, fire, earthquake, material, shortage, late delivery by manufacturers, shipping or transport delay or any other cause beyond the reasonable control of Workspace48 Inc. The Customer shall be bound to accept and pay for goods delivered within a reasonable time after such cause for the failure or delay on the part of Workspace48 Inc. has ceased to operate.
18. To the fullest extent possible, ownership of any goods supplied by Workspace48 Inc. is retained by Workspace48 Inc. until payment in full is made for the goods supplied and for all other goods supplied by Workspace48 Inc. to the Customer. This clause creates a security interest under the Personal Property Securities Act 2009 in favour of Workspace48 Inc. in all present and after-acquired property supplied by Workspace48 Inc. to the Customer. Customers waive the right to be notified in writing of registration on the Personal Property Securities Register.
19. Workspace48 Inc., its servants or its agents may immediately without giving the Customer any notice or waiting any time, retake possession of the goods supplied or any other goods supplied by Workspace48 Inc. under any other arrangement under which title in those goods is still maintained by Workspace48 Inc.
20. The Customer gives Workspace48 Inc. authority for its servants and agents to enter and remain upon any land or premises where in Workspace48 Inc.'s opinion Workspace48 Inc.'s goods may be stored and take possession of the said goods.
21. Under no circumstances shall Workspace48 Inc. be liable for any damage, costs, losses or expenses arising on or resulting from such repossession.
22. The Customer shall hold the proceeds of sales of our goods arising in the normal course of trade, upon trust for Workspace48 Inc. and shall promptly account to Workspace48 Inc. for such proceeds or the amount of them necessary to pay all amounts due to Workspace48 Inc.
23. The failure on the part of Workspace48 Inc. to exercise and enforce any rights conferred by this agreement shall not be deemed to be a waiver of any such right nor operate so as to bar the exercise or enforcement thereof at any time or times thereafter.
24. All freight charges are as described in your company specific discount structure, unless otherwise specified on a project specific quotation.
25. Upon receipt of an approved credit application, orders can be placed in the following way; Phone: 416 441 9898; Email: Orders@workspace48.com. Phone orders are required to have final confirmation in writing. All orders will be acknowledged by email as final confirmation of your order, including net pricing and quantities. If in the unlikely event of low stock, you will be notified and alternative solutions advised.
26. In-stock items can be cancelled by the Customer in writing prior to dispatch, without any cancellation charge. Orders cancelled after shipping and before arrival to the Customer will be subject to a minimum handling fee of \$75 plus any applicable direct costs, payable by the Customer. Any custom built products are not able to be cancelled once the order has been acknowledged and entered into production.

Our Vision

**REVOLUTIONIZING THE WAY OFFICE
FURNITURE IS BOUGHT AND SOLD.**



E info@workspace48.com | P 416 441 9898