

WORKSPACE **48**

CANADA PRICEBOOK | 2023



THE FUTURE OF OFFICE FURNITURE IS HERE.

Workspace48 has some of the best and brightest minds in the office furniture industry Galaxy! We understand the changing office landscape and have an out of this world catalogue of product knowledge to provide the best solutions for any office fit-out project.

It is our mission is to change & revolutionise the office furniture world around one fundamental concept... Everything in this catalogue and in-stock will ship within 48 hours!

Contents

Seating	5
Tables	19
Desking	43
Receptions & Storage	93
Mobile Dividers	101
Accessories & Components.....	105
Product Warranty	110
Freight	112
Terms & Conditions.....	113









Seating

Essence & Compass Task	6
Balance Executive	8
Balance Seating	9
Mode	10
Metro	11
Adapta	12
Luna	13
Game	14
Link	15
Politan	16
Metro	17

Essence Task

Product	Description	Code	CAD
	Essence Black frame Nova fabric seat Adjustable arms	ESS/BCB	989
	Essence White frame Nova Grey fabric seat Adjustable arms	ESS/GGW	1083

Compass Task







Product	Description	Code	CAD
	Compass Black frame Nova fabric seat Adjustable arms Adjustable lumbar	COML/BCB	1336
	Compass White frame Nova Grey fabric seat Adjustable arms Adjustable lumbar	COML/GGW	1416

Please note:

All Essence and Compass seating come standard with hardfloor casters.

THIS PAGE IS INTENTIONALLY
LEFT BLANK

Balance Executive







Product	Description	Code	CAD
	Black faux leather seat Polished alloy base Adjustable arms	BALM/PU	1210
	White faux leather seat Polished alloy base Adjustable arms	BALM/WPU	1210
	Black faux leather seat Polished alloy base Adjustable arms Lumbar	BALML/PU	1293
	Black faux leather seat Polished alloy base Adjustable arms Headrest	BALH/PU	1533
	Upgrade Hardfloor caster	SOFTCAST	31
	Upgrade Chrome footring Bar height	BH_UP	270
	Upgrade Black leather seat cover	BALCOV/L	200
	Upgrade Breathe fabric seat cover	BALMCOV/BR#	61

- Select fabric - Seat covers

Breathe



Balance Seating





Product	Description	Code	CAD
	Visitor Black frame Black mesh backrest Black fabric seat Fixed arms	BALV/BF	572
	Task Black frame Black mesh backrest Black fabric seat Adjustable arms Adjustable height	BALNTA/BF	698
	Training Black frame Black mesh backrest Black fabric seat Fixed arms	BALVA/BF	647
	Training Black frame Black mesh backrest Black fabric seat	BALVNA/BF	647
	Upgrade - Balance Task/Training Hardfloor caster	SOFTCAST	31
	Upgrade - Balance Training Tablet arm kit	ADATAB	132

Please note:

All seating on this page have seat covers which are not removable.

All seating products require partial assembly, except the Link chair and Otto stool.

Mode







Product	Description	Code	CAD
	Highback Black faux leather seat	MODH/PU	980
	Highback White faux leather seat	MODH/WPU	
	Midback Black faux leather seat	MODM/PU	940
	Midback White faux leather seat	MODM/WPU	
	Guest Black faux leather seat	MODV/PU	781
	Guest White faux leather seat	MODV/WPU	
	Boardroom Black faux leather seat	MODMB/PU	940
	Boardroom White faux leather seat	MODMB/WPU	
	Upgrade Hardfloor caster	SOFTCAST	31

Please note:

All Mode seating with arm rests includes covers.

All seating products require partial assembly, except the Link chair and Otto stool.





Metro

Product	Description	Code	CAD
	Highback Black faux leather seat	METH/PU	798
	Highback White faux leather seat	METH/WPU	
	Midback Black faux leather seat	METM/PU	746
	Midback White faux leather seat	METM/WPU	
	Guest Black faux leather seat	METV/PU	545
	Guest White faux leather seat	METV/WPU	
	Boardroom Black faux leather seat	METMB/PU	746
	Boardroom White faux leather seat	METMB/WPU	
	Upgrade Hardfloor caster	SOFTCAST	31
	Upgrade Zipped arm cover Black leather	MARMCOV/B	54
	Upgrade Zipped arm cover White leather	MARMCOV/W	

Please note:

All seating products require partial assembly, except the Link chair and Otto stool.







Adapta

Product	Description	Code	CAD
	Black backrest Black fabric seat Polished alloy base Adjustable arms	ADASBA/BF	531
	White backrest Black fabric seat Polished alloy base Adjustable arms	ADASWA/BF	531
	Upgrade Hardfloor caster	SOFTCAST	31
	Upgrade Tablet arm kit	ADATAB	132
	Upgrade Armless change kit <i>Required for Adapta chair with no arms</i>	ADAWOARM	21

Please note:

All seating products require partial assembly, except the Link chair and Otto stool.

Luna

Product	Description	Code	CAD
	Chair Caster base Black shell Upholstered cushion	LUNAB_CAS/##	526
	Chair Caster base White shell Upholstered cushion	LUNAW_CAS/##	526
	Chair Oak base Black shell Upholstered cushion	LUNAB_OAK/##	547
	Chair Oak base White shell Upholstered cushion	LUNAW_OAK/##	547
	Barstool Oak base Black shell Upholstered cushion	LUNAB_BAR/##	609
	Barstool Oak base White shell Upholstered cushion	LUNAW_BAR/##	609







Please note:

All seating products require partial assembly, except the Link chair and Otto stool.

- Select fabric - upholstered cushion

Motion Felt **AS** **ST** **CL** **DB** **IC** **EM** **BB** **AV** **SO** **CR** Eurotex PU **B** **W**

Game

Product	Description	Code	CAD
	Barstool Chrome frame Charcoal shell	GMBSRSCSN	362
	Barstool Chrome frame Charcoal shell Upholstered seat	GMBSRSCS/B#	396
	Barstool Chrome frame Charcoal shell Upholstered seat + backrest	GMBSRSCF/B#	418
	Chair 4 Leg Chrome Charcoal shell	GM4LRSCN	256
	Chair 4 Leg Chrome Charcoal shell Upholstered seat	GM4LRSCS/B#	289
	Chair 4 Leg Chrome Charcoal shell Upholstered seat + backrest	GM4LRSCF/B#	313

Please note:



All seating products require partial assembly, except the Link chair and Otto stool.

- Select fabric - upholstered cushion(s)

Breathe





Link

Product	Description	Code	CAD
	Silver frame Black shell	LKS/B	169
	Silver frame White shell	LKS/W	169
	Upgrade Trolley Holds up to 25 chairs Black powdercoat	LK/TLY	480

Please note:

All seating products require partial assembly, except the Link chair and Otto stool.

Politan

Product	Description	Code	CAD
	1 Seater Black faux leather	POL1/BPU	950
	2 Seater Black faux leather	POL2/BPU	1042

Please note:

All seating products require partial assembly, except the Link chair and Otto stool.

Otto

Product	Description	Code	CAD
	Ottoman Includes casters	MOSTOOL_#	696

Please note:

All seating products require partial assembly, except the Link chair and Otto stool.

- Select fabric for Ottoman cover

Motion Felt **AS** **ST** **CL** **DB** **IC** **EM** **BB** **AV** **SO** **CR**





Tables

Modulus Overview	20
Modulus Flip.....	24
Modulus Fixed Tables	25
Modulus Collar Leg.....	26
Modulus Accessories.....	27
Modulus Frame Only	28
Axis Tables Overview	34
Axis Tables	36
Axis Bar Leaners	38
Uni Flip Overview.....	40
Uni Flip	41

Modulus Flip

Frames:

Black Matte or Arctic White Powdercoat finish to the posts, rails & pull bars
 Polished alloy feet

Worksurfaces:

1" M2 Grade substrate
 Studio White Melamine finish
 Matching 2mm PVC edge

Features:

Swiveling lockable casters
 Strong flip mechanism has safety stay upright locks

Flip - Small

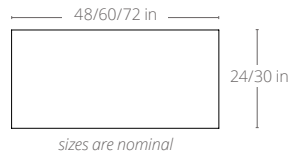
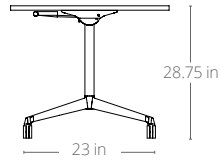

Flip - Large

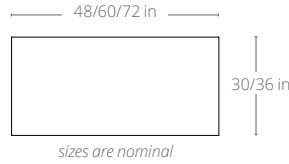
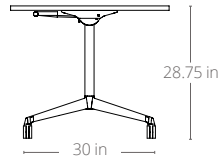

Additional Frame Details

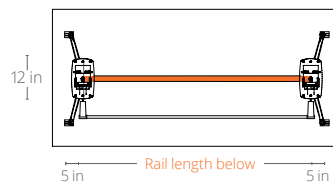
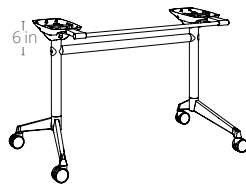
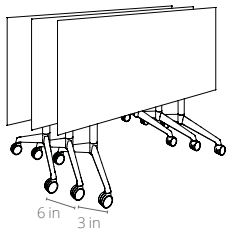

Rail Length Below	
FWFLRAIL50	= 20 in
FWFLRAIL80	= 32 in
FWFLRAIL110	= 44 in
FWFLRAIL140	= 56 in

Modulus Fixed Leg

Frames:

Black Matte Powdercoat finish to all posts & rails
 Polished alloy feet and worktop supports

Worksurfaces:

1" M2 Grade substrate
 Studio White Melamine finish
 Matching 2mm PVC edge

Features:

Leveling glides

Fixed Leg - Small

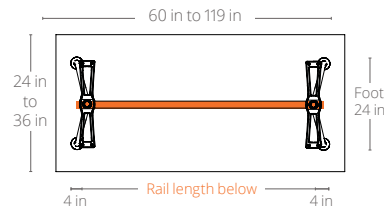
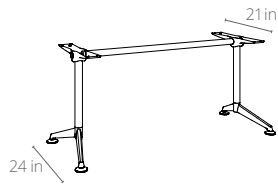

Rail Length Below	
FWTOPRAIL1000	= 40 in
FWTOPRAIL1100	= 50 in
FWTOPRAIL1300	= 58 in
FWTOPRAIL1600	= 68 in
FWTOPRAIL1900	= 81 in
FWTOPRAIL2200	= 93 in

Fixed Leg - Wide

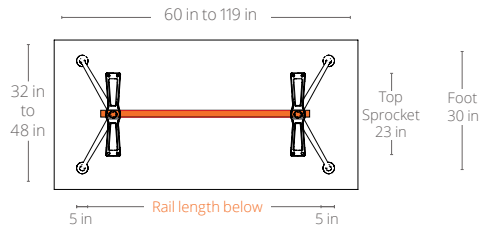
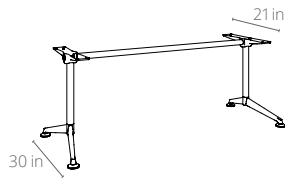

Rail Length Below	
FWTOPRAIL1000	= 40 in
FWTOPRAIL1100	= 50 in
FWTOPRAIL1300	= 58 in
FWTOPRAIL1600	= 68 in
FWTOPRAIL1900	= 81 in
FWTOPRAIL2200	= 93 in

Modulus Collar Leg

Frames:

Black Matte Powdercoat finish to all posts & rails
 Polished alloy feet and worktop supports

Worksurfaces:

1" M2 Grade substrate
 Studio White Melamine finish
 Matching 2mm PVC edge

Features:

Leveling glides

Collar Leg - Twin Post

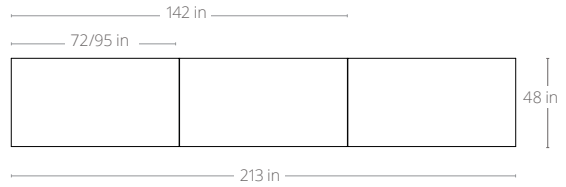
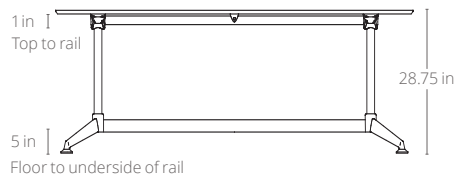

Additional Frame Details

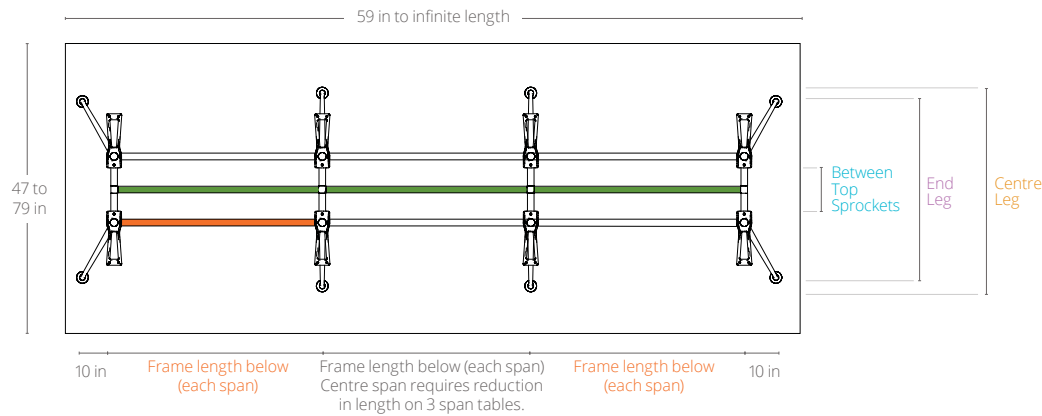

Top rail length (each span) Two beams per span	Lower beam length (each span) One beam per span
FWTOPRAIL1100 = 49 in	FWBOTRAIL1100 = 43 in
FWTOPRAIL1300 = 57 in	FWBOTRAIL1300 = 51 in
FWTOPRAIL1600 = 69 in	FWBOTRAIL1600 = 63 in
FWTOPRAIL1900 = 81 in	FWBOTRAIL1900 = 75 in
FWTOPRAIL2200 = 93 in	FWBOTRAIL2200 = 87 in



Leg Width Kit	End Leg	Centre Leg	Between Top Sprockets Alloy
FW1200	48 in	50 in	7 in
FW1400	55 in	54 in	12 in
FW1600	57 in	62 in	19 in
FW1800	66 in	70 in	27 in

Component Breakdown

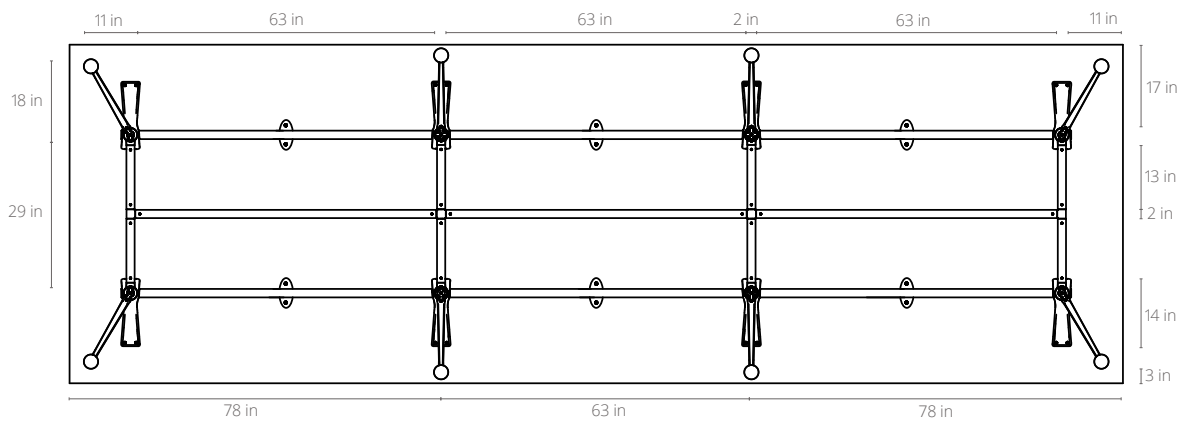
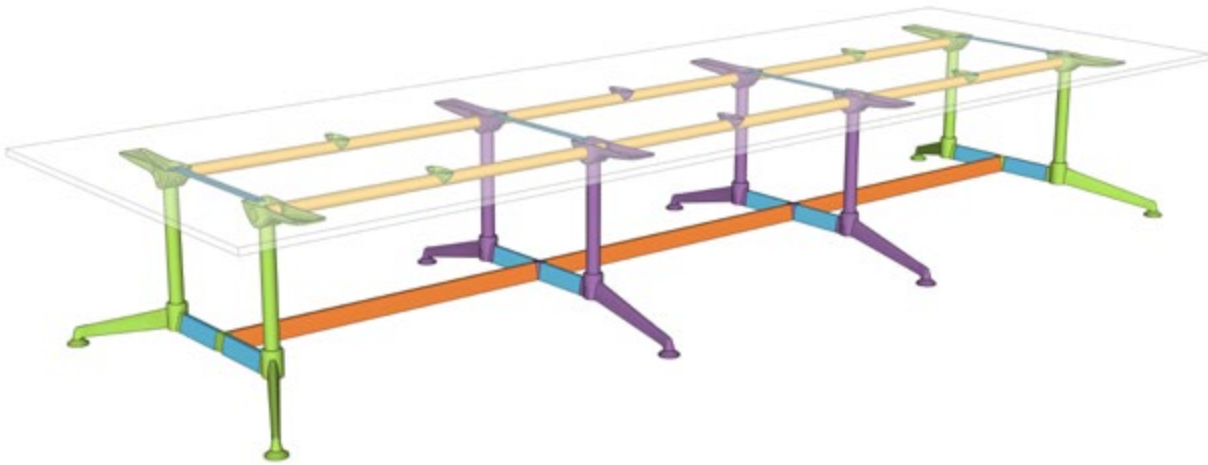
Stockcode/Packs	Description	Quantity
FWMOD-04END_B	Twin Post End Leg Pair with Collar	1
FW1800SET_B	Width Connector Beam	2
FWMOD-04MID_B	Twin Post Centre Leg with Collar	2
FWTOPRAIL1600_B	Upper Rails	6
FWBOTRAIL1600_B	Lower Beam Set	3

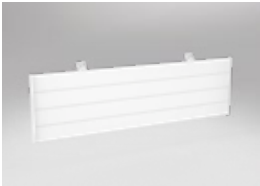
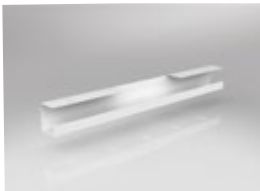

Modulus Flip

Product	Description	Worktop	Code	LPL	HPL
	Flip table Black posts & rails Polished aluminum feet 2x locking casters	48" x 24"	MFLIP126B/#	882	985
		60" x 24"	MFLIP156B/#	940	1075
		72" x 24"	MFLIP186B/#	1003	1127
		48" x 30"	MFLIP1275B/#	918	1056
		60" x 30"	MFLIP1575B/#	989	1152
		72" x 30"	MFLIP1875B/#	1060	1263
		72" x 36"	MFLIP189B/#	1109	1365
	Flip table White posts & rails Polished aluminum feet 2x locking casters	48" x 24"	MFLIP126W/#	882	985
		60" x 24"	MFLIP156W/#	940	1075
		72" x 24"	MFLIP186W/#	1003	1127
		48" x 30"	MFLIP1275W/#	918	1056
		60" x 30"	MFLIP1575W/#	989	1152
		72" x 30"	MFLIP1875W/#	1060	1263
		72" x 36"	MFLIP189W/#	1109	1365
	Accessories Flip table link		GANGMECH/B	66	
	Accessories Modesty kit Powdercoat	Suits top size 48" 31"w x 14"h	MFMOD125/@	240	
		Suits top size 60" 43"w x 14"h	MFMOD145/@	329	
		Suits top size 72" 55"w x 14"h	MFMOD165/@	421	
	Upgrade Cable tray 36" Length Undermount <i>Note: Fits 60"/72"W and 30"D tables only</i>		ELECTRAY900/W	207	

@ - Select modesty finish

Powdercoat





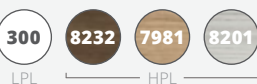

- Select worksurface finish

Laminate



Modulus Tables

Fixed leg

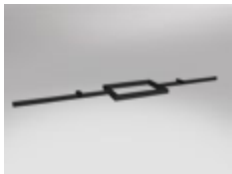
Product	Description	Worktop	Code	LPL	HPL
	Side table Single post	24" x 24" x 18" high	MT66/#	424	449
	Meeting table Single Post Fixed leg Round	36" diameter x 28.75" high	MT090R/#	608	701
		42" diameter x 28.75" high	MT105R/#	664	829
	Meeting table Single Post Fixed leg Square	39" x 39" x 28.75" high	MT1010/#	647	886
	Meeting table Four Post Fixed leg Round	60" diameter x 28.75" high	MT150R/#	1656	1914
	Meeting table 1 Piece Top Fixed leg Rectangle	72" x 24" x 28.75" high	MT186/#	942	1066
		72" x 30" x 28.75" high	MT1875/#	975	1178
		72" x 36" x 28.75" high	MT189/#	1001	1257
		60" x 24" x 28.75" high	MT156/#	864	999
		60" x 30" x 28.75" high	MT1575/#	918	1081
		48" x 24" x 28.75" high	MT126/#	844	947
		48" x 30" x 28.75" high	MT1275/#	859	997
	Upgrade 92.5" post for single post tables to accommodate power module Black matte Suits power boxes up to 20" x 12" <i>Note: Can be cut down to suit shorter tops</i>		FWTOPRAILPBOX2200	386	



- Select worksurface finish

Laminate

300 8232 7981 3201
LPL HPL



Modulus Tables

Collar leg

Product	Description	Worktop	Code	LPL	HPL
	Meeting table 1-piece top Twin post	72" x 48" x 28.75" high	MT1812/#	2032	2336
		95" x 48" x 28.75" high	MT2412/#	2172	2651
	Meeting table 2-piece top Twin post	120" x 48" x 28.75" high	MT3012/#	3209	3783
		142" x 48" x 28.75" high	MT3612/#	3421	3826
	Meeting table 3 piece top Twin post	213" x 48" x 28.75" high	MT5412/#	4903	5815

Modulus Tables with Cutouts

Collar leg

Product	Description	Worktop	Code	LPL	HPL
	Meeting table 1-piece top Twin post	72" x 48" x 28.75" high	MT1812/#-1C	2085	2389
	1 cutout for Interact power module (8.375" x 4.75")	95" x 48" x 28.75" high	MT2412/#-1C	2215	2694
	Meeting table 2-piece top Twin post	120" x 48" x 28.75" high	MT3012/#-2C	3252	3826
	2 cutouts for Interact power module (8.375" x 4.75")	142" x 48" x 28.75" high	MT3612/#-2C	3529	4137
	Meeting table 3-piece top	213" x 48" x 28.75" high	MT5412/#-1C	4955	5815
	Twin post Includes 1-3 cutouts for Interact power module (8.375" x 4.75")	213" x 48" x 28.75" high	MT5412/#-2C	5009	5867
		213" x 48" x 28.75" high	MT5412/#-3C	5062	5921



-1C, -2C, -3C in part number code, indicates how many sections require cutouts.

- Select worksurface finish

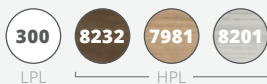
Laminate







Modulus Accessories

Product	Description	Code	CAD
	<p>Power module White Includes 2 outlets, 3 RJ45 108" cord length Custom telecom plates available on special order</p>	ACT-21/GW-108	894
	<p>Cable cobra Black Power/data segregation</p>	CABCOBRA/B	87
	<p>Cable clutch - set of 5 White Below desk cable management</p>	CABCLUTCH_W	44







Modulus Flip

Frame only

Product	Description	Suits Worktop Length	Code	CAD
	Flip table frame Black - standard Suits worksurface depth 24 - 36"	36" - 51"	MFLIP050/B	692
		48" - 63"	MFLIP080/B	712
		60" - 75"	MFLIP110/B	728
		72" - 84"	MFLIP140/B	756
	Flip table frame White - standard - Suits worksurface depth 24 - 36"	36" - 51"	MFLIP050/W	692
		48" - 63"	MFLIP080/W	712
		60" - 75"	MFLIP110/W	728
		72" - 84"	MFLIP140/W	756
	Flip table frame Black - large Suits worksurface depth 30" - 41"	36" - 51"	MFLIPL050/B	836
		48" - 63"	MFLIPL080/B	854
		60" - 75"	MFLIPL110/B	875
		72" - 84"	MFLIPL140/B	901
	Flip table frame White - large Suits worksurface depth 30" - 41"	36" - 51"	MFLIPL050/W	836
		48" - 63"	MFLIPL080/W	854
		60" - 75"	MFLIPL110/W	875
		72" - 84"	MFLIPL140/W	901

Modulus Tables



Frame only

Product	Description	Suits Worktop Size	Code	CAD
	Meeting table frame Frame height: 17" Polished aluminum feet	16"-28" round 16"-24" square	CA-FWMOD11.16R/B	331
	Meeting table frame Frame height: 27.75" Polished aluminum feet	16"-28" round 16"-24" square	CA-FWMOD11.15R/B	333
	Meeting table frame Frame height: 27.75" Polished aluminum feet	32"-48" round 28"-39" square	CA-FWMOD11.1R/B	429
	Meeting table frame Frame height: 27.75" Polished aluminum feet	54"-72" round 48"-66" square	CA-FWMOD11.2R/B	1248
	Upgrade Bar-height poles Suitable for: Single post pedestal base	Frame height 41" High	MODZA22-808	137*
	Upgrade Bar-height poles Suitable for: 4 post pedestal base	Frame height 41" High	MODZA22-758	71*

*Price is per pole



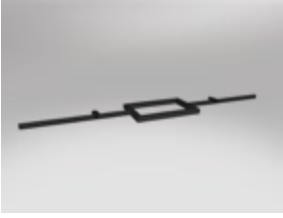

Modulus Tables

Fixed leg - frame only

Product	Description	Suits Worktop Length	Code	CAD
	Meeting table frame Small fixed leg Suits worksurface depth of 24"-30"	48"-54"	MT1206F/B	650
		55"-75"	MT1406F/B	654
		63"-83"	MT1606F/B	672
	Meeting table frame Large fixed leg Suits worksurface depth of 30"-36"	48"-54"	MT1208F/B	659
		55"-75"	MT1408F/B	674
		63"-83"	MT1608F/B	695
	Upgrade 92.5" Long post for single post tables to accommodate power module Black Suits powerboxes up to 20" x 12" Note: Can be cut down to suit shorter tops		FWTOPRAILPBOX2200	386

Modulus Tables





Collar leg - frame only

Product	Description	Suits Worktop Length	Code	CAD
	Meeting table frame Single span Suits work surface depth of 48"-54"	67"-83"	MT1412CC/B	1615
		74"-95"	MT1612CC/B	1616
		99"-118"	MT1912CC/B	1666
		110"-130"	MT2512CC/B	1769
	Meeting table frame Single span Suits work surface depth of 55"-62"	67"-83"	MT1414CC/B	1636
		74"-95"	MT1614CC/B	1637
		99"-118"	MT1914CC/B	1687
		110"-130"	MT2514CC/B	1790
	Meeting table frame Single span Suits work surface depth of 64"-69"	67"-83"	MT1416CC/B	1665
		74"-95"	MT1616CC/B	1665
		99"-118"	MT1916CC/B	1715
		110"-130"	MT2516CC/B	1819
	Meeting table frame Single span Suits work surface depth of 72"-79"	67"-83"	MT1418CC/B	1667
		74"-95"	MT1618CC/B	1699
		99"-118"	MT1918CC/B	1747
		110"-130"	MT2518CC/B	1852
	Upgrade Bar-height poles Twin pole/four pole Pedestal base	Frame height 41" High	MODZA22-758	71*

*Price is per pole, order qty will depend on the size of the base.

Modulus Tables

Collar leg - frame only

Product	Description	Suits Worktop Length	Code	CAD
	Meeting table frame Double Span Suits worksurface depth of 48"-54"	114"-130"	MT2612CC2/B	2480
		130"-146"	MT3012CC2/B	2542
		154"-169"	MT3612CC2/B	2656
		201"-217"	MT4812CC2/B	2848
	Meeting table frame Double Span Suits worksurface depth of 55"-62"	114"-130"	MT2614CC2/B	2508
		130"-146"	MT3014CC2/B	2569
		154"-169"	MT3614CC2/B	2697
		201"-217"	MT4814CC2/B	2876
	Meeting table frame Double Span Suits worksurface depth of 64"-69"	114"-130"	MT2616CC2/B	2554
		130"-146"	MT3016CC2/B	2615
		154"-169"	MT3616CC2/B	2740
		201"-217"	MT4816CC2/B	2876
	Meeting table frame Double Span Suits worksurface depth of 72"-79"	114"-130"	MT2618CC2/B	2602
		130"-146"	MT3018CC2/B	2664
		154"-169"	MT3618CC2/B	2789
		201"-217"	MT4818CC2/B	2971
	Upgrade Bar-height poles Twin pole/Four pole Pedestal base	41" High	MODZA22-758	72*

*Price is per pole, order qty will depend on the size of the base.

Modulus Tables

Collar leg - frame only

Product	Description	Suits Worktop Length	Code	CAD
	Meeting table frame Triple Span Suits worksurface depth of 48"-54"	158"-177"	MT3712CC3/B	3348
		181"-201"	MT4312CC3/B	3437
		217"-232"	MT5212CC3/B	3646
		288"-303"	MT7012CC3/B	4545
	Meeting table frame Triple Span Suits worksurface depth of 55"-62"	158"-177"	MT3714CC3/B	3385
		181"-201"	MT4314CC3/B	3526
		217"-232"	MT5214CC3/B	3621
		288"-303"	MT7014CC3/B	4581
	Meeting table frame Triple Span Suits worksurface depth of 64"-69"	158"-177"	MT3716CC3/B	3446
		181"-201"	MT4316CC3/B	3544
		217"-232"	MT5216CC3/B	3682
		288"-303"	MT7016CC3/B	4640
	Meeting table frame Triple Span Suits worksurface depth of 72"-79"	158"-177"	MT3718CC3/B	3562
		181"-201"	MT4318CC3/B	3600
		217"-232"	MT5218CC3/B	3621
		288"-303"	MT7018CC3/B	4708

Axis Tables

Frames:

Silver or Arctic White
Powdercoat finish to all
posts and rails

Worksurfaces:

1" M2 Grade substrate
Studio White Melamine finish
Matching 2mm PVC edge

Coffee Table

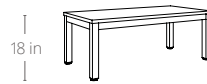
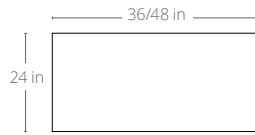
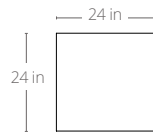

Meeting Table

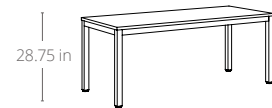
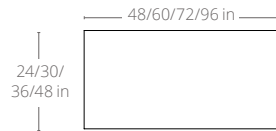
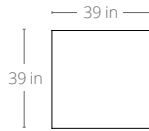
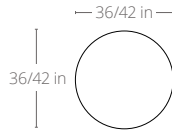

* All dimensions are nominal

Axis Bar Leaner

Frames:

Black Matte or Arctic White
Powdercoat finish to all
posts and rails

Worksurfaces:

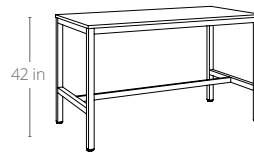
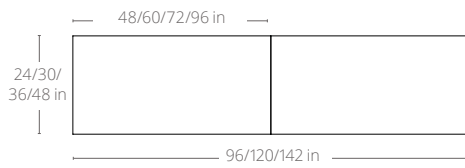

1" M2 Grade substrate
Studio White Melamine finish
Matching 2mm PVC edge

Bar Leaner



** All dimensions are nominal*

Axis Tables

Product	Description	Worktop	Code	LPL	HPL
	Coffee table 18" height	24" x 24"	AXCT66/##	421	446
		36" x 24"	AXCT96/##	514	578
		48" x 24"	AXCT126/##	588	691
	Meeting table 28.75" height	48" x 24"	AXT126/##	668	771
		60" x 24"	AXT156/##	736	871
		72" x 24"	AXT186/##	805	929
		48" x 30"	AXT1275/##	720	858
		60" x 30"	AXT1575/##	815	978
		72" x 30"	AXT1875/##	876	1079
		72" x 36"	AXT189/##	896	1152
		60" x 48"	AXT1512/##	1169	1456
		72" x 48"	AXT1812/##	1056	1360
		96" x 48"	AXT2412/##	1088	1567
	Meeting table round 28.75" height	36" diameter	AXT090R/##	520	613
		42" diameter	AXT105R/##	539	704
		60" diameter	AXT150R/##	790	1048
	Meeting table square 28.75" height	39" x 39"	AXT1010/##	685	924

- Select finishes

Powdercoat





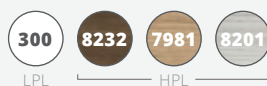

+ Laminate



Axis Tables

Frame only

Product	Description	Suits Worktop	Code	CAD
	Coffee table 18" height	24" x 24"	AXCT66/#_F	362
		36" x 24"	AXCT96/#_F	393
		48" x 24"	AXCT126/#_F	418
	Meeting table 28.75" height	48" x 24"	AXT126/#_F	496
		60" x 24"	AXT156/#_F	529
		72" x 24"	AXT186/#_F	557
		48" x 30"	AXT1275/#_F	515
		60" x 30"	AXT1575/#_F	546
		72" x 30"	AXT1875/#_F	576
		72" x 36"	AXT189/#_F	591
		60" x 48"	AXT1512/#_F	798
		72" x 48"	AXT-1812/#_F	613
		96" x 48"	AXT-2412/#_F	655
		96" x 48" (Inset legs)	AXT2412I/#_F	655
			Meeting table round 28.75" height	36" diameter
42" diameter	AXT-105R/#_F			303
60" diameter	AXT-150R/#_F			303
	Meeting table square 28.75" height	39" x 39"	AXT-1010/#_F	303



- Select frame finish

Powdercoat

S

W

Axis Bar Leaner

Product	Description	Worktop	Code	LPL	HPL
	Bar leaner Single worktop	48" x 24"	AXBL1260/##	856	959
		60" x 24"	AXBL1560/##	910	1045
		72" x 24"	AXBL1860/##	936	1060
		48" x 30"	AXBL1275/##	1003	1141
		60" x 30"	AXBL1575/##	1008	1171
		72" x 30"	AXBL1875/##	1081	1248
		72" x 36"	AXBL1890/##	1122	1378
		60" x 48"	AXBL1512/##	1186	1473
		72" x 48"	AXBL1812/##	1289	1593
		96" x 48"	AXBL2412/##	1496	1975
	Bar leaner Double worktop	96" x 24"	AXBL2460/##	1572	1778
		120" x 24"	AXBL3060/##	1734	2004
		142" x 24"	AXBL3660/##	1878	2126
		96" x 30"	AXBL2475/##	1678	1954
		120" x 30"	AXBL3075/##	1865	2191
		142" x 30"	AXBL3675/##	2019	2126
		142" x 36"	AXBL3690/##	2079	2591
		120" x 48"	AXBL3012/##	2190	2764
		142" x 48"	AXBL3612/##	2401	3009

- Select finishes

Powdercoat



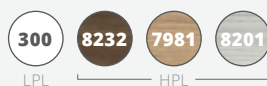

+ Laminate



Axis Bar Leaner

Frame only

Product	Description	Suits Worktop	Code	CAD
	Bar leaner Frame only Single worktop	48" x 24"	AXBL1260/#_F	686
		60" x 24"	AXBL1560/#_F	705
		72" x 24"	AXBL1860/#_F	730
		48" x 30"	AXBL1275/#_F	749
		60" x 30"	AXBL1575/#_F	760
		72" x 30"	AXBL1875/#_F	779
		72" x 36"	AXBL1890/#_F	819
		60" x 48"	AXBL1512/#_F	816
		72" x 48"	AXBL1812/#_F	854
		96" x 48"	AXBL2412/#_F	954
	Bar leaner Frame only Double worktop	96" x 24"	AXBL2460/#_F	1233
		120" x 24"	AXBL3060/#_F	1320
		142" x 24"	AXBL3660/#_F	1384
		96" x 30"	AXBL2475/#_F	1268
		120" x 30"	AXBL3075/#_F	1352
		142" x 30"	AXBL3675/#_F	1416
		142" x 36"	AXBL3690/#_F	1471
		120" x 48"	AXBL3012/#_F	1448
		142" x 48"	AXBL3612/#_F	1528

- Select frame finish

Powdercoat



Uni Flip

Frames:

Silver Powdercoat finish to all posts, rails & pull bars

Worksurfaces:

1" M2 Grade substrate
Studio White Melamine finish
Matching 2mm PVC edge

Features:

Swiveling lockable casters

Flip - Small

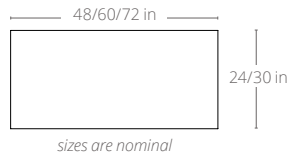
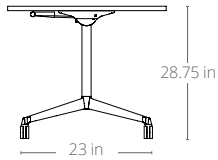

Additional Frame Details

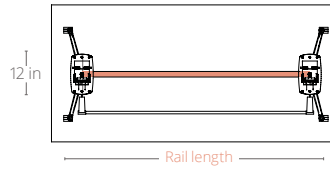
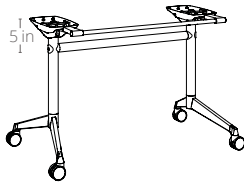
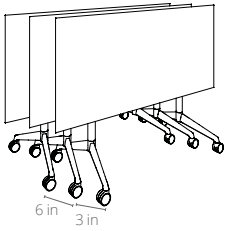

Rail Length	
FWFLRAIL50	= 32 in
FWFLRAIL80	= 42 in
FWFLRAIL110	= 55 in
FWFLRAIL140	= 67 in

Uni Flip

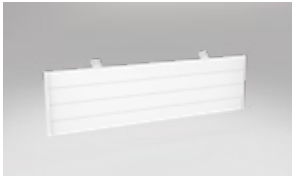
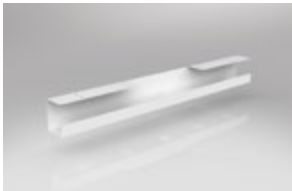
Product	Description	Worktop	Code	LPL	HPL
	Flip table Silver frame 2 x locking casters	48" x 24"	UNIFLIP1260S/#	810	913
		60" x 24"	UNIFLIP1560S/#	874	1009
		72" x 24"	UNIFLIP1860S/#	937	1061
		48" x 30"	UNIFLIP1275S/#	848	986
		60" x 30"	UNIFLIP1575S/#	922	1085
		72" x 30"	UNIFLIP1875S/#	991	1194
		72" x 36"	UNIFLIP189S/#	994	1250
	Accessories Modesty kit Powdercoat	Suits top size 48", 31"w x 14"h	MFMOD125/@	240	
		Suits top size 60", 43"w x 14"h	MFMOD145/@	329	
		Suits top size 72", 55"w x 14"h	MFMOD165/@	421	
		Flip table link	Ganging mechanism	GANGMECH/B	66
	Upgrade Cable tray 36" Length Undermount		ELECTRAY900/W	207	

Uni Flip - Frame Only

Product	Description	Suits Worktop Length	Code	CAD
	Flip Table Frame only Silver frame 2 x locking casters Suits worksurface depth of 24"-36"	36" - 48"	UNIFLIP50/S	618
		48" - 60"	UNIFLIP80/S	639
		60" - 72"	UNIFLIP110/S	663
		72" - 96"	UNIFLIP140/S	688

- Select worksurface finish

Laminate

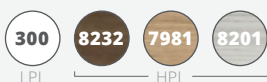

@ - Select modesty finish

Powdercoat







Desking

Agile Plus Overview	44
Agile Plus	45
Agile Overview	48
Agile Winder	49
Agile Electric	50
Agile Accessories.....	52
Axis Overview	56
Axis Desking	58
Axis Shared Desking	60
Axis Shared Workstations	64
Axis Dividers & Accessories.....	70
Axis Electrical	73
Anvil Overview	74
Anvil Desking.....	76
Anvil Shared Desking.....	78
Anvil Shared Workstations.....	82
Anvil Dividers & Accessories.....	88
Anvil Electrical.....	91

Agile Plus Desking

Frames:

Dual synchronized motors with microprocessor control and thermosensor
 Black or Arctic White
 Powdercoat finish to frame
 2.4" square legs
 Flat foot design - single sided desk
 H frame design - double sided desk
 Height adjustable - electric

Worksurfaces:

1" M2 Grade substrate
 4 Melamine finish options
 Matching 2mm PVC edge

Features:

Ultra quiet dual motor frame
 2 controller options, memory presets
 Super soft start stop
 Anti-collision software
 Weight rating: 225lbs
 Electric speed: 1.6"/s

Single Sided Desk

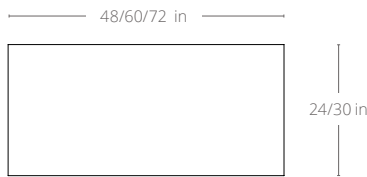

Double Sided Desk

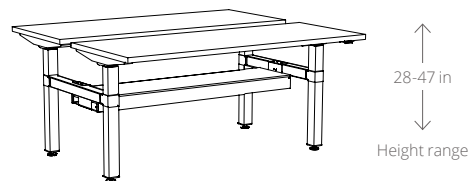
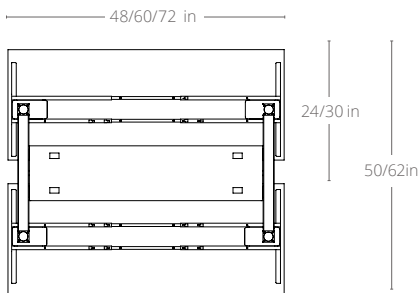

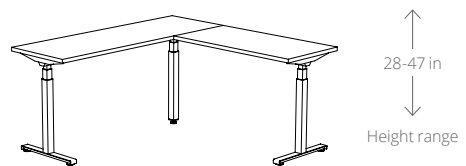
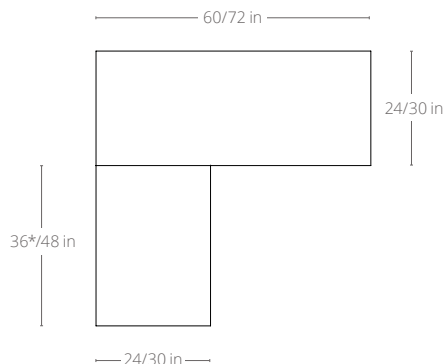

90° Workstation



* 36 in return surface only available in 24 in depth

Agile Plus Desking

Electric height adjustable

Product	Description	Worktop	Code	LPL	HPL
	Single sided desk Electric adjust	48" x 24"	AGPE2SSD126/###	1985	2088
		48" x 30"	AGPE2SSD1275/###	2032	2160
		60" x 24"	AGPE2SSD156/###	2025	2160
		60" x 30"	AGPE2SSD1575/###	2076	2239
		72" x 24"	AGPE2SSD186/###	2068	2192
		72" x 30"	AGPE2SSD1875/###	2124	2327
	Double sided desk Electric adjust	2@ 48" x 24"	AGPE2DSD126/###	3820*	4026*
		2@ 48" x 30"	AGPE2DSD1275/###	3914*	4170*
		2@ 60" x 24"	AGPE2DSD156/###	3900*	4170*
		2@ 60" x 30"	AGPE2DSD1575/###	4002*	4328*
		2@ 72" x 24"	AGPE2DSD186/###	3986*	4234*
		2@ 72" x 30"	AGPE2DSD1875/###	4098*	4504*
	Single sided desk Frame only Electric adjust	48" x 24"	AGPE2SSD126/#_F	1799	
		48" x 30"	AGPE2SSD1275/#_F	1799	
		60" x 24"	AGPE2SSD156/#_F	1799	
		60" x 30"	AGPE2SSD1575/#_F	1799	
		72" x 24"	AGPE2SSD186/#_F	1799	
		72" x 30"	AGPE2SSD1875/#_F	1799	
	Double sided desk Frame only Electric adjust	2@ 48" x 24"	AGPE2DSD126/#_F	3448*	
		2@ 48" x 30"	AGPE2DSD1275/#_F	3448*	
		2@ 60" x 24"	AGPE2DSD156/#_F	3448*	
		2@ 60" x 30"	AGPE2DSD1575/#_F	3448*	
		2@ 72" x 24"	AGPE2DSD186/#_F	3448*	
		2@ 72" x 30"	AGPE2DSD1875/#_F	3448*	
	Upgrade Modesty panel Laminate	42.5" wide x 12" deep	AGM12/#	84	124
		54.5" wide x 12" deep	AGM15/#	85	125
		66.25" wide x 12" deep	AGM18/#	101	147

*Price is per back-to-back unit

- Select finishes

Powdercoat



+ Laminate

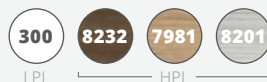

Agile Plus Workstations

Electric height adjustable

Product	Description	Worktop	Code	LPL	HPL
	Left hand return 90° Electric adjust	60' x 24"/36" x 24"	AGP3MEW1561656/#L#	3465	3664
		60' x 24"/48" x 24"	AGP3MEW156186/#L#	3522	3760
		60' x 30"/36" x 24"	AGP3MEW15751656/#L#	3516	3743
		72' x 24"/36" x 24"	AGP3MEW1861656/#L#	3508	3696
		72' x 24"/48" x 24"	AGP3MEW186186/#L#	3565	3792
		72' x 30"/36" x 24"	AGP3MEW18751656/#L#	3564	3831
	Right hand return 90° Electric adjust	60' x 24"/36" x 24"	AGP3MEW1561656/#R#	3465	3664
		60' x 24"/48" x 24"	AGP3MEW156186/#R#	3522	3760
		60' x 30"/36" x 24"	AGP3MEW15751656/#R#	3516	3743
		72' x 24"/36" x 24"	AGP3MEW1861656/#R#	3508	3696
		72' x 24"/48" x 24"	AGP3MEW186186/#R#	3565	3792
		72' x 30"/36" x 24"	AGP3MEW18751656/#R#	3564	3831
	90° Workstation Frame only Electric adjust	60"-72" x 60"-72" / 24"-30"	AG3MEW18186/#_F	3110	

Controller Upgrade

	Controller Pro 4 memory presets Electronic display	AGMP4/B	131
-------------------------------------------------------------------------------------	-----------------------------------------------------------------	---------	-----

- Select finishes

Powdercoat **B** **W** + Laminate **300** **8232** **7981** **8201**

LPL HPL

Agile Plus Cable Management

Product	Description	Dimensions	Code	CAD
	Cable tray* Single sided	48" Length	AGPSSDCM12/#	772
		60" Length	AGPSSDCM15/#	804
		72" Length	AGPSSDCM18/#	854
	Cable tray* Double sided	48" Length	AGPDSDCM12/#	310
		60" Length	AGPDSDCM15/#	396
		72" Length	AGPDSDCM18/#	482
	Bridge with cover* For single sided desk		AGPSBRIDGE/#	125
	Bridge with cover* For double sided desk		AGPDBRIDGE/B	154
	Cable tray Undermount	36" Length	ELECTRAY900/#	207
	Cable cobra	42.5" Length	CABCOBRA/#	87
	Cable clutch Set of 5		CABCLUTCH_W	44

***Please note:**

Cable trays marked (*) are only applicable to Agile Plus and not standard Agile. See page 51 for standard Agile cable management.

- Select finish

Colour

B

W

Agile Desking

Frames:

Black or Arctic White
 Powdercoat finish to frame
 3.55 x 2.4" legs
 Flat foot design - single
 sided desk
 H frame design - double
 sided desk
 Height adjustable - electric
 or winder

Worksurfaces:

1" M2 Grade substrate
 Studio White Melamine
 finish
 Matching 2mm PVC edge

Features:

Weight rating 250lbs
 Winder speed: ¼"/turn
 Electric speed: 1"/s

Single Sided Desk

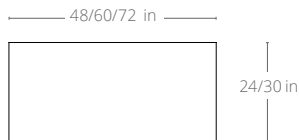

Double Sided Desk

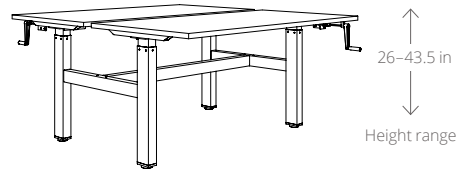
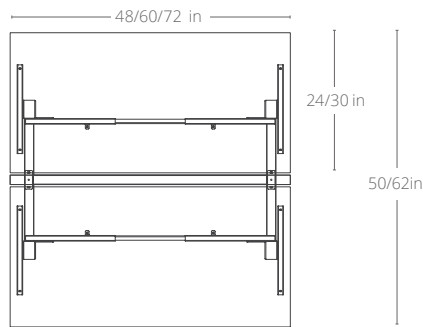

90° Workstation

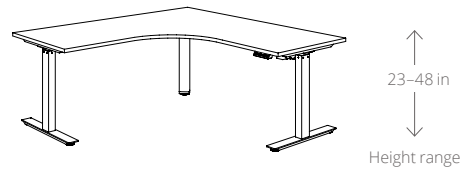
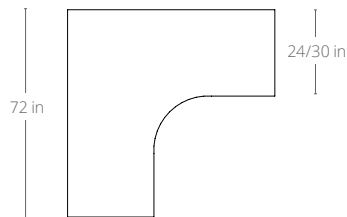

120° Workstation

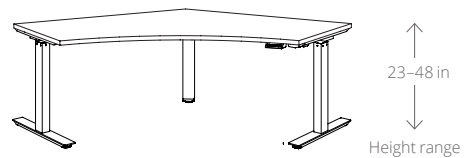
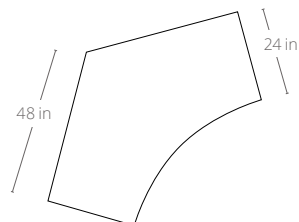

Agile Desking

Winder height adjustable

Product	Description	Worktop	Code	LPL	HPL
	Single sided desk Winder adjust	48" x 24"	AGWSSD126/##	1011	1114
		48" x 30"	AGWSSD1275/##	1039	1177
		60" x 24"	AGWSSD156/##	1070	1205
		60" x 30"	AGWSSD1575/##	1081	1244
		72" x 24"	AGWSSD186/##	1104	1228
		72" x 30"	AGWSSD1875/##	1147	1350
	Double sided desk Winder adjust	2@ 48" x 24"	AGWSDSD126/##	2147*	2353*
		2@ 48" x 30"	AGWSDSD1275/##	2207*	2483*
		2@ 60" x 24"	AGWSDSD156/##	2215*	2485*
		2@ 60" x 30"	AGWSDSD1575/##	2292*	2618*
		2@ 72" x 24"	AGWSDSD186/##	2358*	2606*
		2@ 72" x 30"	AGWSDSD1875/##	2449*	2855*
	Single sided desk Frame only Winder adjust	48" x 24"	AGWSSD126/#_F	870	
		48" x 30"	AGWSSD1275/#_F	870	
		60" x 24"	AGWSSD156/#_F	898	
		60" x 30"	AGWSSD1575/#_F	898	
		72" x 24"	AGWSSD186/#_F	898	
		72" x 30"	AGWSSD1875/#_F	898	
	Double sided desk Frame only Winder adjust	2@ 48" x 24"	AGWSDSD126/#_F	1863*	
		2@ 48" x 30"	AGWSDSD1275/#_F	1863*	
		2@ 60" x 24"	AGWSDSD156/#_F	1872*	
		2@ 60" x 30"	AGWSDSD1575/#_F	1872*	
		2@ 72" x 24"	AGWSDSD186/#_F	1950*	
		2@ 72" x 30"	AGWSDSD1875/#_F	1950*	
	Upgrade Modesty panel Laminate	42.5" wide x 12" deep	AGM12/#	84	124
		54.5" wide x 12" deep	AGM15/#	85	125
		66.25" wide x 12" deep	AGM18/#	101	147





*Price is per back-to-back unit

- Select finishes

Powdercoat B W + **Laminate** 300 8232 7981 8201
LPL HPL

Agile Desking

Electric height adjustable

Product	Description	Worktop	Code	LPL	HPL
	Single sided desk Electric adjust	48" x 24"	AGE2SSD126/#	1429	1532
		48" x 30"	AGE2SSD1275/#	1458	1596
		60" x 24"	AGE2SSD156/#	1460	1595
		60" x 30"	AGE2SSD1575/#	1500	1663
		72" x 24"	AGE2SSD186/#	1523	1647
		72" x 30"	AGE2SSD1875/#	1567	1770
	Double sided desk Electric adjust	2@ 48" x 24"	AGE2DSD126/#	2828*	3034*
		2@ 48" x 30"	AGE2DSD1275/#	2888*	3164*
		2@ 60" x 24"	AGE2DSD156/#	2892*	3162*
		2@ 60" x 30"	AGE2DSD1575/#	2975*	3301*
		2@ 72" x 24"	AGE2DSD186/#	3037*	3285*
		2@ 72" x 30"	AGE2DSD1875/#	3128*	3534*
	Single sided desk Frame only Electric adjust	48" x 24"	AGE2SSD126/#_F	1289	
		48" x 30"	AGE2SSD1275/#_F	1289	
		60" x 24"	AGE2SSD156/#_F	1289	
		60" x 30"	AGE2SSD1575/#_F	1289	
		72" x 24"	AGE2SSD186/#_F	1318	
		72" x 30"	AGE2SSD1875/#_F	1318	
	Double sided desk Frame only Electric adjust	2@ 48" x 24"	AGE2DSD126/#_F	2547*	
		2@ 48" x 30"	AGE2DSD1275/#_F	2547*	
		2@ 60" x 24"	AGE2DSD156/#_F	2549*	
		2@ 60" x 30"	AGE2DSD1575/#_F	2549*	
		2@ 72" x 24"	AGE2DSD186/#_F	2627*	
		2@ 72" x 30"	AGE2DSD1875/#_F	2627*	
	Upgrade Modesty panel Laminate	42.5" wide x 12" deep	AGM12/W	84	124
		54.5" wide x 12" deep	AGM15/W	85	125
		66.25" wide x 12" deep	AGM18/W	101	147

*Price is per back-to-back unit

- Select finishes

Powdercoat





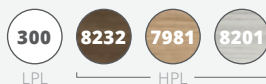

+ Laminate



Agile Workstations

Electric height adjustable

Product	Description	Worktop	Code	LPL	HPL
	90° Workstation - Left Electric adjust	72" x 72"/24"	AG3MEW18186/WL300		2959
		72" x 72"/30"	AG3MEW181875/WL300		
	90° Workstation - Right Electric adjust	72" x 72"/24"	AG3MEW18186/WR300		2959
		72" x 72"/30"	AG3MEW181875/WR300		
	120° Workstation Electric adjust	48" x 48"/24"	AG3MEW12126/###	2969	3395
	90° Workstation Frame only Electric adjust	60"-76" x 60"-76"/24"	AG3MEW18186/#_F		2523
		60"-76" x 60"-76"/30"	AG3MEW181875/#_F		
	120° Workstation Frame only Electric adjust	48"-72" x 48"-72"/24"	AG3MEW12126/#_F		2523

- Select finishes





Powdercoat

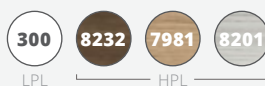

+ Laminate

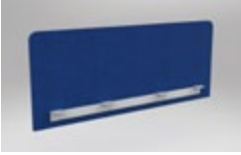
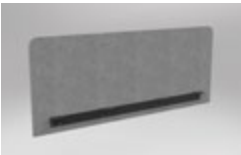

Agile e-Panel Screens

Product	Description	Dimensions	Code	CAD
	Clamp on Screen* E-panel .75" thickness	47"W x 24"H	EPSSD120060/#	219
	*Not for Agile Plus	59"W x 24"H	EPSSD150060/#	361
	Edge Undermount White bracket E-panel .75" thickness	47"W x 24"H	AGESE120060/W#	359
		59"W x 24"H	AGESE150060/W#	481
	Edge Undermount Black bracket E-panel .75" thickness	47"W x 24"H	AGESE120060/B#	359
		59"W x 24"H	AGESE150060/B#	481
	Return Screen E-panel Pure Black 1" thickness	23"W x 12"H	SSCRN6030/PB10	166
		29"W x 12"H	SSCRN7530/PB10	176
	Return Screen E-panel Spectrum Red 1" thickness	23"W x 12"H	SSCRN6030/SP15	166
		29"W x 12"H	SSCRN7530/SP15	176
	Return Screen E-panel Deep Grey 1" thickness	23"W x 12"H	SSCRN6030/DG37	166
		29"W x 12"H	SSCRN7530/DG37	176
	Return Screen E-panel Bright Blue 1" thickness	23"W x 12"H	SSCRN6030/BB21	166
		29"W x 12"H	SSCRN7530/BB21	176

- Select finishes

e-Panel

SP15

DG37

BB21

*Please note:

Spine screens marked (*) are only applicable to standard Agile and not Agile Plus.

Agile Cable Management

Product	Description	Dimensions	Code	CAD
	Cable tray* Single sided	48" Length	AGSSDCM12/#	389
		60" Length	AGSSDCM15/#	529
		72" Length	AGSSDCM18/#	564
	Cable tray* Double sided	48" Length	AGSDCM12/#	329
		60" Length	AGSDCM15/#	365
		72" Length	AGSDCM18/#	440
	Cable tray Undermount	36" Length	ELECTRAY900/#	207
	Cable cobra	42.5" Length	CABCOBRA/#	87
	Cable clutch Set of 5		CABCLUTCH_W	44

***Please note:**



Cable trays marked (*) are only applicable to standard Agile and not Agile Plus. See page 45 for Agile Plus cable management.

- Select finish

Colour

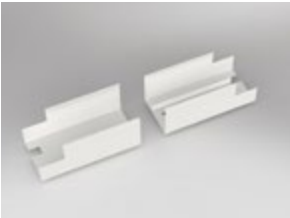

Agile Brackets





Product	Description	Dimensions	Code	CAD
	Brackets (pair) For single sided desk cable tray	24"-32" deep	AGSSDBRAC/#	118
	Bridge with cover For single sided desk		AGSBRIDGE/#-IT-C	83
	Bridge with cover For double sided desk		AGDBRIDGE/#-1-C	99

- Select finish

Powdercoat



Agile Electrical

Product	Description	Dimensions	Code	CAD
	<p>Voltra Agile I - White 3 outlets 2 USB 108" cord</p>		AGPM3O2U-W-108	228
	<p>Voltra Agile II - Black 3 outlets 1 USB-A, 1 USB-C 108" cord</p>		AGPM3O1U1C-B-108	243
	<p>Voltra Agile II - White 3 outlets 1 USB-A, 1 USB-C 108" cord</p>		AGPM3O1U1C-W-108	243
	<p>One Duplex For one duplex in tray</p>		ELECTRICAL_1	247
	<p>Two Duplex For two duplexes in tray</p>		ELECTRICAL_2	450
	<p>Base Infeed Hardwire</p>	Standard - 72"	EHINFD-72	272
	<p>Ceiling Infeed Hardwire</p>	Standard - 144"	EHINFD-144	326

Please note:

All electrical prices include all required jumper cables, connecting hardware, duplexes, electrical face plate, data face plate with four knockouts, and 6' or 12' hardwired infeed.

Axis Desking

Frames:

Arctic White or Silver
 Powdercoat finish to frame
 2 x 2" square legs
 2 x 1" rails
 28.75" Worksurface height

Worksurfaces:

1" M2 Grade substrate
 Studio White Melamine finish
 Matching 2mm PVC edge
 90° worksurface comes as with join at 47" along the left or right hand side

Spine Screens:

Translucent or E-panel insert to top 11.82"
 White Melamine below
 0.82" thickness
 Sits 19.7" above desk height
 All brackets & trims included
 E-panel is available in Ignite Red or Black and has a tackable core

Desk

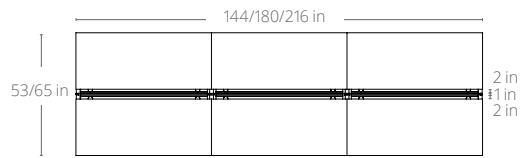

90° Workstation

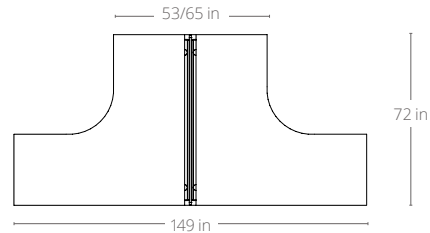
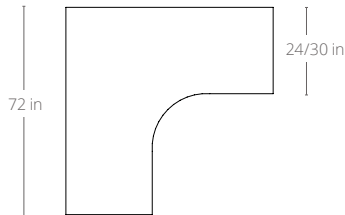

120° Workstation

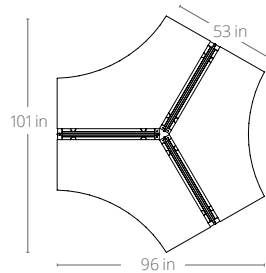
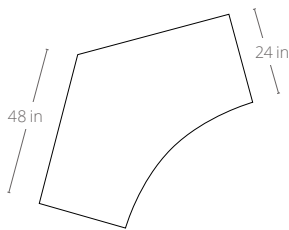

Desk & Return

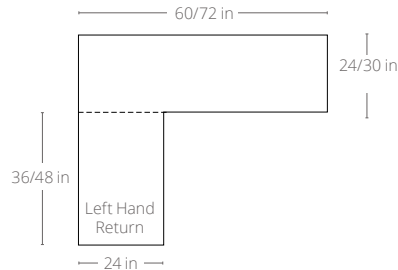

* All dimensions are nominal

Standard Divider

Spine Screens

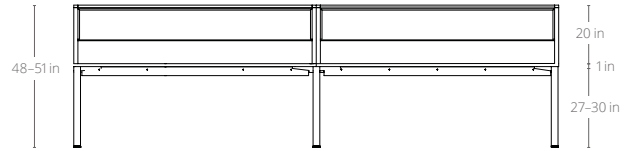
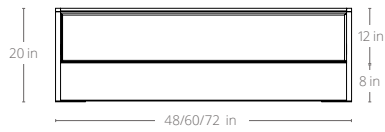

Desk Hung Screens

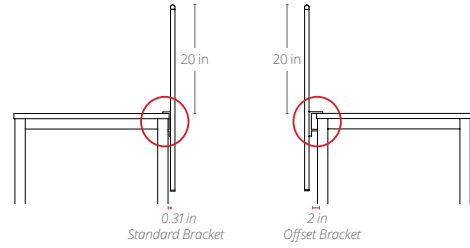
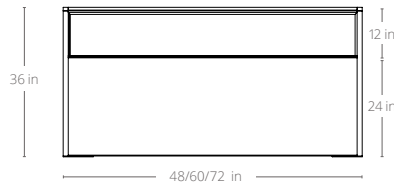

Return Screens

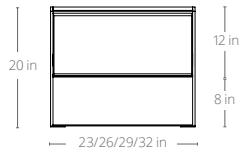

Devise Divider

Spine Screens

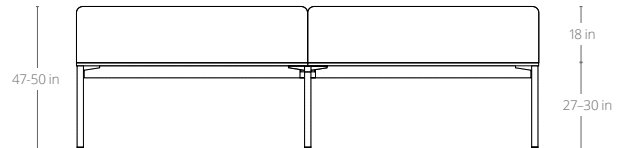
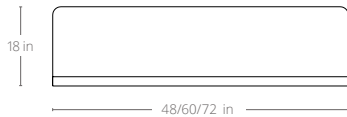

Desk Hung Screens

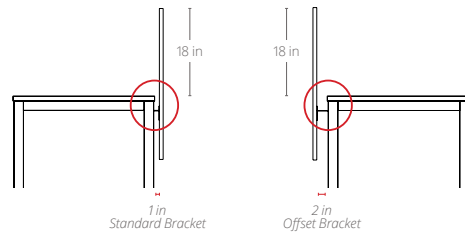
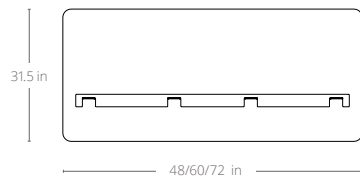



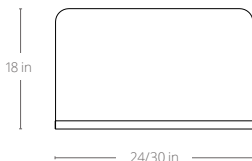

Return Screens



* All dimensions are nominal

Axis Desking

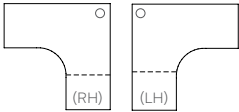

Product	Description	Worktop	Code	LPL	HPL
	Desk Fixed height	48" x 24"	AXSD126/##	589	692
		48" x 30"	AXSD1275/###	668	806
		60" x 24"	AXSD156/##	649	784
		60" x 30"	AXSD1575/###	738	901
		72" x 24"	AXSD186/##	704	828
		72" x 30"	AXSD1875/###	800	1003
		72" x 36" <i>Includes 6" conference front</i>	AXSD189/##	805	1061
	90° Workstation Fixed height	72" x 72"/24"	AX9W18186/#L300	1177	
		72" x 72"/24"	AX9W18186/#R300	1177	
		72" x 72"/30"	AX9W181875/#L300	1235	
		72" x 72"/30"	AX9W181875/#R300	1235	
	120° Workstation Fixed height	48" x 48"/24"	AX12W12126/##	1337	1763
	Upgrade Modesty panel Laminate	42.5" wide x 12" deep	AXM12/#	97	137
		54.5" wide x 12" deep	AXM15/#	99	139
		66.25" wide x 12" deep	AXM18/#	114	160



- Select finishes

Powdercoat frame **S** **W** + Laminate **300** **8232** **7981** **8201**
LPL HPL

Axis Desk & Return

Product	Description	Worktop	Code	LPL	HPL
	Left hand return Fixed height	60" x 24"/36" x 24"	AXDR156156/#L#	949	1148
		60" x 30"/36" x 24" <i>Includes 6" conference front</i>	AXDR1575176/#L#	1372	1599
		60" x 24"/48" x 24"	AXDR156186/#L#	1012	1250
		60" x 30"/48" x 24" <i>Includes 6" conference front</i>	AXDR1575206/#L#	1446	1712
		72" x 24"/36" x 24"	AXDR186156/#L#	1001	1189
		72" x 30"/36" x 24" <i>Includes 6" conference front</i>	AXDR1875176/#L#	1434	1701
		72" x 24"/48" x 24"	AXDR186186/#L#	1067	1294
		72" x 30"/48" x 24" <i>Includes 6" conference front</i>	AXDR1875206/#L#	1505	1811
	Right hand return Fixed height	60" x 24"/36" x 24"	AXDR156156/#R#	949	1148
		60" x 30"/36" x 24" <i>Includes 6" conference front</i>	AXDR1575176/#R#	1372	1599
		60" x 24"/48" x 24"	AXDR156186/#R#	1012	1250
		60" x 30"/48" x 24" <i>Includes 6" conference front</i>	AXDR1575206/#R#	1446	1712
		72" x 24"/36" x 24"	AXDR186156/#R#	1001	1189
		72" x 30"/36" x 24" <i>Includes 6" conference front</i>	AXDR1875176/#R#	1434	1701
		72" x 24"/48" x 24"	AXDR186186/#R#	1067	1294
		72" x 30"/48" x 24" <i>Includes 6" conference front</i>	AXDR1875206/#R#	1505	1811
	Upgrade Modesty panel Laminate	42.5" wide x 12" deep	AXM12/#	97	137
		54.5" wide x 12" deep	AXM15/#	99	139
		66.25" wide x 12" deep	AXM18/#	114	160

- Select finishes



Powdercoat frame

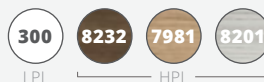

+ Laminate



Axis Shared Desking

Product	Description	Worktop	Code	LPL*	HPL*
	Desk Single sided 2 User	2 @ 48" x 24"	AX2SSD126/##	1056	1262
		2 @ 48" x 30"	AX2SSD1275/##	1197	1473
		2 @ 60" x 24"	AX2SSD156/##	1172	1442
		2 @ 60" x 30"	AX2SSD1575/##	1340	1666
		2 @ 72" x 24"	AX2SSD186/##	1284	1532
		2 @ 72" x 30"	AX2SSD1875/##	1462	1868
	Desk Single sided 3 User	3 @ 48" x 24"	AX3SSD126/##	1519	1828
		3 @ 48" x 30"	AX3SSD1275/##	1730	2144
		3 @ 60" x 24"	AX3SSD156/##	1696	2101
		3 @ 60" x 30"	AX3SSD1575/##	1947	2436
		3 @ 72" x 24"	AX3SSD186/##	1860	2232
		3 @ 72" x 30"	AX3SSD1875/##	2124	2733
	Upgrade Modesty panel Laminate	42.5" wide x 12" deep	AXM12/#	97	137
		54.5" wide x 12" deep	AXM15/#	99	139
		66.25" wide x 12" deep	AXM18/#	114	160

*All shared desking shows pricing per pod.

Please note:

Single sided desk cable management can be found on page 104

- Select finishes

Powdercoat frame



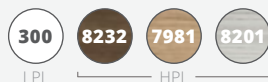

+

Laminate



Axis Shared Desking

Product	Description	Worktop	Code	LPL*	HPL*
	Desk Double sided 2 User Cable trays	2 @ 48" x 24"	AX2DSD126/##	1319	1525
		2 @ 48" x 30"	AX2DSD1275/##	1425	1701
		2 @ 60" x 24"	AX2DSD156/##	1476	1746
		2 @ 60" x 30"	AX2DSD1575/##	1615	1941
		2 @ 72" x 24"	AX2DSD186/##	1642	1890
		2 @ 72" x 30"	AX2DSD1875/##	1789	2195
	Desk Double sided 4 User Cable trays	4 @ 48" x 24"	AX4DSD126/##	2315	2727
		4 @ 48" x 30"	AX4DSD1275/##	2509	3061
		4 @ 60" x 24"	AX4DSD156/##	2642	3182
		4 @ 60" x 30"	AX4DSD1575/##	2882	3534
		4 @ 72" x 24"	AX4DSD186/##	2961	3457
		4 @ 72" x 30"	AX4DSD1875/##	3234	4046
	Desk Double sided 6 User Cable trays	6 @ 48" x 24"	AX6DSD126/##	3329	3947
		6 @ 48" x 30"	AX6DSD1275/##	3621	4449
		6 @ 60" x 24"	AX6DSD156/##	3801	4611
		6 @ 60" x 30"	AX6DSD1575/##	4149	5127
		6 @ 72" x 24"	AX6DSD186/##	4304	5048
		6 @ 72" x 30"	AX6DSD1875/##	4664	5882

*All shared desking shows pricing per pod.

Please note:

Cable tray covers can be found on page 105

- Select finishes

Powdercoat frame



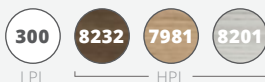

+ Laminate



Axis Shared Desking

With standard screens

Product	Description	Worktop	Code	LPL*	HPL*
 <p>Desk Double sided 2 User Spine screens Cable trays</p>		2 @ 48" x 24"	AX2DSD126/###	1642	1848
		2 @ 48" x 30"	AX2DSD1275/###	1750	2026
		2 @ 60" x 24"	AX2DSD156/###	1890	2160
		2 @ 60" x 30"	AX2DSD1575/###	2027	2353
		2 @ 72" x 24"	AX2DSD186/###	2104	2352
		2 @ 72" x 30"	AX2DSD1875/###	2253	2659
 <p>Desk Double sided 4 User Spine screens Cable trays</p>		4 @ 48" x 24"	AX4DSD126/###	2998	3410
		4 @ 48" x 30"	AX4DSD1275/###	3188	3740
		4 @ 60" x 24"	AX4DSD156/###	3499	4039
		4 @ 60" x 30"	AX4DSD1575/###	3735	4387
		4 @ 72" x 24"	AX4DSD186/###	3938	4434
		4 @ 72" x 30"	AX4DSD1875/###	4190	5002
 <p>Desk Double sided 6 User Spine screens Cable trays</p>		6 @ 48" x 24"	AX6DSD126/###	4354	4972
		6 @ 48" x 30"	AX6DSD1275/###	4621	5449
		6 @ 60" x 24"	AX6DSD156/###	5111	5921
		6 @ 60" x 30"	AX6DSD1575/###	5447	6425
		6 @ 72" x 24"	AX6DSD186/###	5763	6507
		6 @ 72" x 30"	AX6DSD1875/###	6130	7348

*All shared desking shows pricing per pod.

Please note:

Comseal covers can be found on page 104



- Select finishes

Powdercoat frame (desk)
S
W
 + **Laminate**
300
8232
7981
8201
 + **Screen insert**
I
B
T

LPL
HPL
Panel PVC

Axis Shared Desking

With Devise screens

Product	Description	Worktop	Code	LPL*	HPL*
	Desk Double sided 2 User Spine screens Cable trays	2 @ 48" x 24"	AX2DSD126/###	1847	2053
		2 @ 48" x 30"	AX2DSD1275/###	1968	2244
		2 @ 60" x 24"	AX2DSD156/###	2126	2396
		2 @ 60" x 30"	AX2DSD1575/###	2280	2606
		2 @ 72" x 24"	AX2DSD186/###	2367	2615
		2 @ 72" x 30"	AX2DSD1875/###	2534	2940
	Desk Double sided 4 User Spine screens Cable trays	4 @ 48" x 24"	AX4DSD126/###	3373	3785
		4 @ 48" x 30"	AX4DSD1275/###	3587	4139
		4 @ 60" x 24"	AX4DSD156/###	3936	4476
		4 @ 60" x 30"	AX4DSD1575/###	4202	4854
		4 @ 72" x 24"	AX4DSD186/###	4429	4925
		4 @ 72" x 30"	AX4DSD1875/###	4714	5526
	Desk Double sided 6 User Spine screens Cable trays	6 @ 48" x 24"	AX6DSD126/###	4897	5515
		6 @ 48" x 30"	AX6DSD1275/###	5198	6026
		6 @ 60" x 24"	AX6DSD156/###	5750	6560
		6 @ 60" x 30"	AX6DSD1575/###	6127	7105
		6 @ 72" x 24"	AX6DSD186/###	6484	7228
		6 @ 72" x 30"	AX6DSD1875/###	6896	8114

*All shared desking shows pricing per pod.

Please note:

Eclipse tray covers can be found on page 71

- Select finishes

Powdercoat frame (desk)



+

Laminate

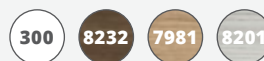





+

E-Panel Color



LPL HPL

Axis 90° Workstations

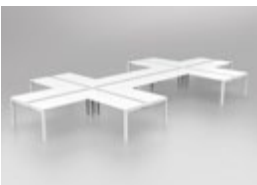
Product	Description	Worktop	Code	LPL*	HPL*
	90° Workstation 2 User	2 @ 72" x 72" x 24"	AX2U186186/##	1991	2445
		2 @ 72" x 72" x 30"	AX2U187187/##	2228	2910
	90° Workstation T layout 2 User Cable trays	2 @ 72" x 72" x 24"	AX2T186186/##	2428	2882
		2 @ 72" x 72" x 30"	AX2T187187/##	2653	3335
	90° Workstation Plus layout 4 User Cable trays	4 @ 72" x 72" x 24"	AX4P186186/##	4549	5457
		4 @ 72" x 72" x 30"	AX4P187187/##	4957	6321
	90° Workstation H layout 4 User Cable trays	4 @ 72" x 72" x 24"	AX4H186186/##	4549	5457
		4 @ 72" x 72" x 30"	AX4H187187/##	4957	6321
	90° Workstation 6 User Cable trays	6 @ 72" x 72" x 24"	AX6PT186186/##	7594	8956
		6 @ 72" x 72" x 30"	AX6PT187187/##	8193	10239
	90° Workstation Double plus layout 8 User Cable trays	8 @ 72" x 72" x 24"	AX8P186186/##	10639	12455
		8 @ 72" x 72" x 30"	AX8P187187/##	11413	14141

*All shared desking shows pricing per pod.

Please note:

Cable tray covers can be found on page 105

- Select finishes

Powdercoat frame





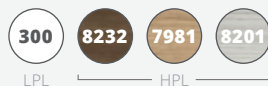

+

Laminate



Axis 90° Workstations

With standard screens

Product	Description	Worktop	Code	LPL*	HPL*
	90° Workstation T layout 2 User Spine screens Cable trays	2 @ 72" x 72" x 24"	AX2T186186/###	2894	3348
		2 @ 72" x 72" x 30"	AX2T187187/###	3116	3798
	90° Workstation Plus layout 4 User Spine screens Cable trays	4 @ 72" x 72" x 24"	AX4P186186/###	5514	6422
		4 @ 72" x 72" x 30"	AX4P187187/###	5922	7286
	90° Workstation H layout 4 User Spine screens Cable trays	4 @ 72" x 72" x 24"	AX4H186186/###	5514	6422
		4 @ 72" x 72" x 30"	AX4H187187/###	5922	7286
	90° Workstation 6 User Spine screens Cable trays	6 @ 72" x 72" x 24"	AX6PT186186/###	9929	11291
		6 @ 72" x 72" x 30"	AX6PT187187/###	10528	12574
	90° Workstation Double plus layout 8 User Spine screens Cable trays	8 @ 72" x 72" x 24"	AX8P186186/###	14373	16189
		8 @ 72" x 72" x 30"	AX8P187187/###	15155	17883

*All shared desking shows pricing per pod.

Please note:

Comseal covers can be found on page 104

- Select finishes

Powdercoat frame (desk)
S
W
+
Laminate
300
8232
7981
8201
+
Screen insert
I
B
T

LPL
HPL
e-Panel
PVC

Axis 90° Workstations

With Devise screens

Product	Description	Worktop	Code	LPL*	HPL*
	90° Workstation T layout 2 User Spine screens	2 @ 72" x 72" x 24"	AX2T186186/###	3283	3737
	Cable trays	2 @ 72" x 72" x 30"	AX2T187187/###	3522	4204
	90° Workstation Plus layout 4 User Spine screens	4 @ 72" x 72" x 24"	AX4P186186/###	6259	7167
	Cable trays	4 @ 72" x 72" x 30"	AX4P187187/###	6696	8060
	90° Workstation H layout 4 User Spine screens	4 @ 72" x 72" x 24"	AX4H186186/###	6259	7167
	Cable trays	4 @ 72" x 72" x 30"	AX4H187187/###	6696	8060
	90° Workstation 6 User Spine screens	6 @ 72" x 72" x 24"	AX6PT186186/###	11254	12616
	Cable trays	6 @ 72" x 72" x 30"	AX6PT187187/###	11895	13941
	90° Workstation Double plus layout 8 User Spine screens	8 @ 72" x 72" x 24"	AX8P186186/###	16281	18097
	Cable trays	8 @ 72" x 72" x 30"	AX8P187187/###	17118	19846

*All shared desking shows pricing per pod.

Please note:

Eclipse tray covers can be found on page 71

- Select finishes

Powdercoat frame (desk)



+

Laminate

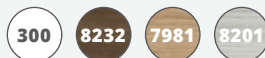

+

E-Panel Color



LPL ————— HPL

Axis 120° Workstations

Product	Description	Worktop	Code	LPL*	HPL*
	120° Workstation 3 User Cable trays	3 @ 48" x 48" x 24"	AX3SW12126/##	4043	5321
	120° Workstation 6 User Cable trays	6 @ 48" x 48" x 24"	AX6SW12126/##	8086	10642
	120° Workstation 9 User Cable trays	9 @ 48" x 48" x 24"	AX9SW12126/##	12129	15963
	120° Workstation 12 User Cable trays	12 @ 48" x 48" x 24"	AX12SW12126/##	16171	21283
	120° Workstation 18 User Cable trays	18 @ 48" x 48" x 24"	AX18SW12126/##	24257	31925

*All shared desking shows pricing per pod.

Please note:





Cable tray covers can be found on page 105

- Select finishes

Powdercoat frame **S** **W** + Laminate **300** **8232** **7981** **8201**
LPL HPL

Axis 120° Workstations

With standard screens

Product	Description	Worktop	Code	LPL*	HPL*
	120° Workstation 3 User Spine screens Cable trays	3 @ 48" x 48" x 24"	AX3SW12126/###	5080	6358
	120° Workstation 6 User Spine screens Cable trays	6 @ 48" x 48" x 24"	AX6SW12126/###	10160	12716
	120° Workstation 9 User Spine screens Cable trays	9 @ 48" x 48" x 24"	AX9SW12126/###	15240	19074
	120° Workstation 12 User Spine screens Cable trays	12 @ 48" x 48" x 24"	AX12SW12126/###	20320	25432
	120° Workstation 18 User Spine screens Cable trays	18 @ 48" x 48" x 24"	AX18SW12126/###	30479	38147

*All shared desking shows pricing per pod.

Please note:

Comseal covers can be found on page 104

- Select finishes

Powdercoat frame (desk) S W + **Laminate** 300 8232 7981 8201 + **Screen insert** I B T

LPL HPL e-Panel PVC

Axis 120° Workstations

With Devise screens

Product	Description	Worktop	Code	LPL*	HPL*
	120° Workstation 3 User Spine screens Cable trays	3 @ 48" x 48" x 24"	AX3SW12126/###	5715	6993
	120° Workstation 6 User Spine screens Cable trays	6 @ 48" x 48" x 24"	AX6SW12126/###	11430	13986
	120° Workstation 9 User Spine screens Cable trays	9 @ 48" x 48" x 24"	AX9SW12126/###	17144	20978
	120° Workstation 12 User Spine screens Cable trays	12 @ 48" x 48" x 24"	AX12SW12126/###	22860	27972
	120° Workstation 18 User Spine screens Cable trays	18 @ 48" x 48" x 24"	AX18SW12126/###	34289	41957

*All shared desking shows pricing per pod.

Please note:

Eclipse tray covers can be found on page 71

- Select finishes

Powdercoat frame (desk) S W + Laminate 300 8232 7981 8201 + E-Panel Color DBL DCH DGR

LPL HPL

Axis Desk Hung Screens

Product	Description	Dimensions	Code	CAD
	Desk hung screen	48" x 36" high	AXHS12OFF/#	565
		60" x 36" high	AXHS15OFF/#	733
		72" x 36" high	AXHS18OFF/#	778
		48" x 36" high	AXHS12/#	530
		60" x 36" high	AXHS15/#	700
		72" x 36" high	AXHS18/#	746

Please note:

Offset Bracket code (OFF) is for screens used on single sided Axis Straightline workstations.

- Select Screen Insert

E-panel



OR

Translucent



Axis Desk Hung Screens

Product	Description	Dimensions	Code	CAD
	Desk hung screen	48" x 36" high	DHS48OFF/#	788
		60" x 36" high	DHS60OFF/#	635
		72" x 36" high	DHS72OFF/#	875
		48" x 36" high	DHS48/#	597
		60" x 36" high	DHS60/#	839
		72" x 36" high	DHS72/#	825

Please note:



Offset Bracket code (OFF) is for screens used on single sided Axis Straightline workstations.

- Select Screen Colour



E-panel



Standard Return Screens

Product	Description	Dimensions	Code	CAD
	Return screen Single sided desks	23" x 20" high	AXSRS58/#	200
		29" x 20" high	AXSRS73/#	221
	Return screen Double sided desks	26" x 20" high	AXRS65/#	186
		32" x 20" high	AXRS80/#	219
	Return screen Double sided desks end of run	26" x 20" high	AXRS65/#_E	201
		32" x 20" high	AXRS80/#_E	236

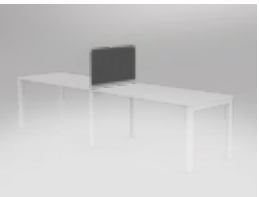
Devise Return Screens

Product	Description	Dimensions	Code	CAD
	Return screen Single and double sided desks	23" x 12" high	DRS5931/#	185
		29" x 12" high	DRS7431/#	218
	Return screen Single and double sided desks	23" x 18" high	DRS5946/#	225
		29" x 18" high	DRS7446/#	248

- Select Standard Screen Insert

E-panel



OR

Translucent







- Select Devise Screen Colour

E-panel



Axis Electrical

Product	Description	Dimensions	Code	CAD
	Voltra power module 3 outlets 2 USB-A 108" cord		AXPM3O2U-W-108	228
	One Duplex For one duplex in tray		ELECTRICAL_1	247
	Two Duplex For two duplexes in tray		ELECTRICAL_2	450
	Base Infeed Hardwire	Standard - 72"	EHINFD-72	272
	Ceiling Infeed Hardwire	Standard - 144"	EHINFD-144	326

Accessories

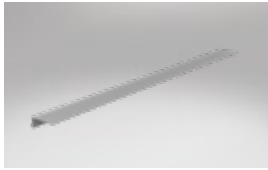
Product	Description	Dimensions	Code	CAD
	Eclipse Tray Tidy Flexible PVC tray cover	48"	ECTT48	75
		60"	ECTT60	92
		72"	ECTT72	109

Please note:

- All electrical prices include all required jumper cables, connecting hardware, duplexes, electrical face plate, and data face plate with four knockouts
- Single-sided desks can only have below desk electrical, and double sided desks can only have above desk electrical.

Anvil Desking

Frames:

Arctic White Powdercoat finish to frame
 2 x 2 x 2" triangle legs
 2 x 1" rails
 28.75" Worksurface height

Worksurfaces:

1" M2 Grade substrate
 Studio White Melamine finish
 Matching 2mm PVC edge
 90° worksurface comes as with join at 47" along the left or right hand side
 Double sided desks include comseal covers

Spine Screens:

Translucent or E-panel insert to top 11.82"
 White Melamine below
 0.82" thickness
 Sits 19.7" above desk height
 All brackets & trims included
 E-panel is available in Ignite Red or Black and has a tackable core

Desk

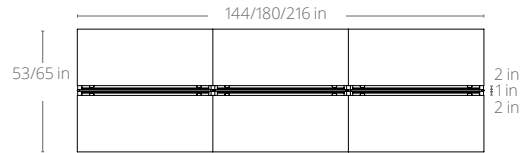
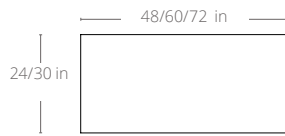

90° Workstation

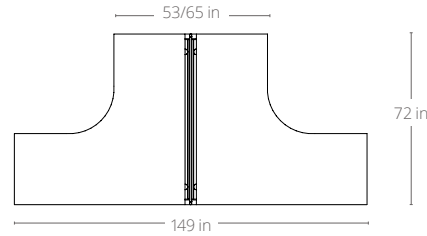
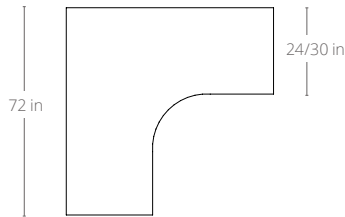

120° Workstation

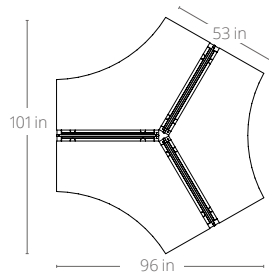
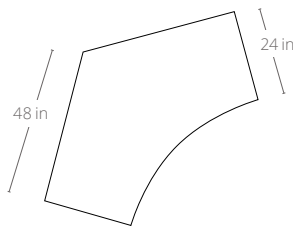

Desk & Return

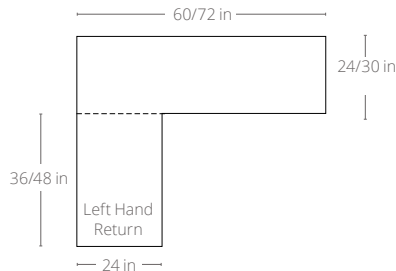

* All dimensions are nominal

Standard Dividers

Spine Screens

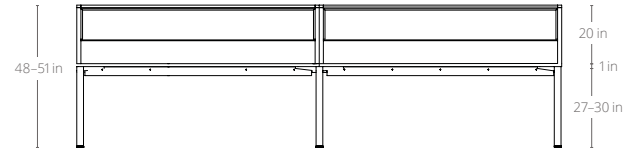
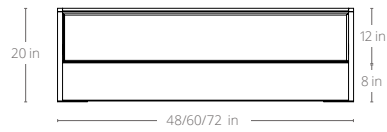

Desk Hung Screens

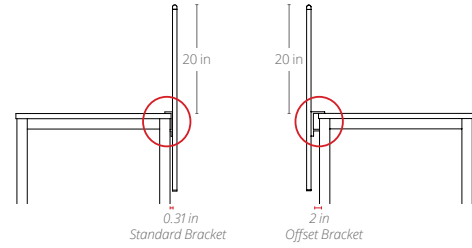
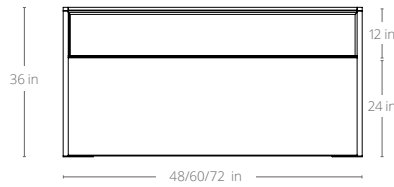

Return Screens

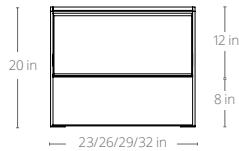

Devise Dividers

Spine Screens

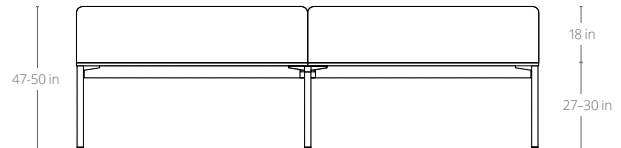
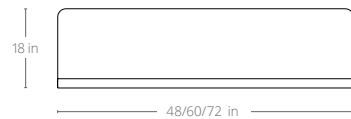

Desk Hung Screens

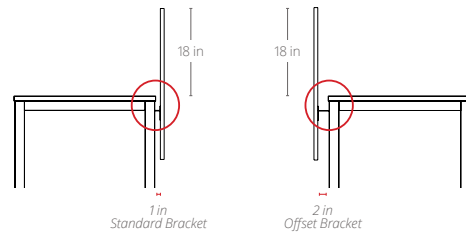
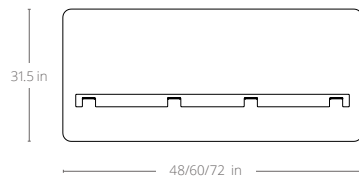



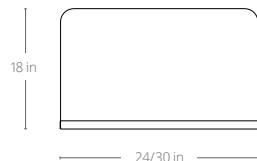

Return Screens



* All dimensions are nominal

Anvil Desking



Product	Description	Worktop	Code	LPL	HPL
	Desk Fixed height	48" x 24"	ANSD126/W#	705	808
		48" x 30"	ANSD1275/W#	834	972
		60" x 24"	ANSD156/W#	762	897
		60" x 30"	ANSD1575/W#	902	1065
		72" x 24"	ANSD186/W#	816	940
		72" x 30"	ANSD1875/W#	962	1165
		72" x 36" <i>Includes 6" conference front</i>	ANSD1890/W#	965	1221
	90° Workstation Fixed height	72" x 72"/24"	AN9W18186/WL#	1274	
		72" x 72"/24"	AN9W18186/WR#	1274	
		72" x 72"/30"	AN9W181875/WL#	1407	
		72" x 72"/30"	AN9W181875/WR#	1407	
	120° Workstation Fixed height	48" x 48"/24"	AN12W12126/W#	1285	1711
	Upgrade Modesty panel Laminate	42.5" wide x 12" deep	AXM12/#	97	137
		54.5" wide x 12" deep	AXM15/#	99	139
		66.25" wide x 12" deep	AXM18/#	114	160

- Select Worksurface Finish

Worksurface
300
8232
7981
3201





LPL
HPL

Anvil Desk & Return



Product	Description	Worktop	Code	LPL	HPL
 <p>Left hand return Fixed height</p>		60" x 24"/36" x 24"	ANDR156156/WL#	1051	1250
		60" x 30"/36" x 24" <i>Includes 6" conference front</i>	ANDR1575176/WL#	1644	1871
		60" x 24"/48" x 24"	ANDR156186/WL#	1116	1354
		60" x 30"/48" x 24" <i>Includes 6" conference front</i>	ANDR1575206/WL#	1717	1983
		72" x 24"/36" x 24"	ANDR186156/WL#	1105	1293
		72" x 30"/36" x 24" <i>Includes 6" conference front</i>	ANDR1875176/WL#	1703	1970
		72" x 24"/48" x 24"	ANDR186186/WL#	1168	1395
		72" x 30"/48" x 24" <i>Includes 6" conference front</i>	ANDR1875206/WL#	1774	2080
 <p>Right hand return Fixed height</p>		60" x 24"/36" x 24"	ANDR156156/WR#	1051	1250
		60" x 30"/36" x 24" <i>Includes 6" conference front</i>	ANDR1575176/WR#	1644	1871
		60" x 24"/48" x 24"	ANDR156186/WR#	1116	1354
		60" x 30"/48" x 24" <i>Includes 6" conference front</i>	ANDR1575206/WR#	1717	1983
		72" x 24"/36" x 24"	ANDR186156/WR#	1105	1293
		72" x 30"/36" x 24" <i>Includes 6" conference front</i>	ANDR1875176/WR#	1703	1970
		72" x 24"/48" x 24"	ANDR186186/WR#	1168	1395
		72" x 30"/48" x 24" <i>Includes 6" conference front</i>	ANDR1875206/WR#	1774	2080
 <p>Upgrade Modesty panel Laminate</p>		42.5" wide x 12" deep	AXM12/#	97	137
		54.5" wide x 12" deep	AXM15/#	99	139
		66.25" wide x 12" deep	AXM18/#	114	160

- Select Worksurface Finish

Worksurface

			
LPL	HPL		

Anvil Shared Desking

Product	Description	Worktop	Code	LPL*	HPL*
	Desk Single sided 2 User	2 @ 48" x 24"	AN2SSD126/W#	1168	1374
		2 @ 48" x 30"	AN2SSD1275/W#	1367	1643
		2 @ 60" x 24"	AN2SSD156/W#	1282	1552
		2 @ 60" x 30"	AN2SSD1575/W#	1505	1831
		2 @ 72" x 24"	AN2SSD186/W#	1385	1633
		2 @ 72" x 30"	AN2SSD1875/W#	1634	2040
	Desk Single sided 3 User	3 @ 48" x 24"	AN3SSD126/W#	1631	1940
		3 @ 48" x 30"	AN3SSD1275/W#	1898	2312
		3 @ 60" x 24"	AN3SSD156/W#	1795	2200
		3 @ 60" x 30"	AN3SSD1575/W#	2103	2592
		3 @ 72" x 24"	AN3SSD186/W#	1960	2332
		3 @ 72" x 30"	AN3SSD1875/W#	2283	2892
	Upgrade Modesty panel Laminate	42.5" wide x 12" deep	AXM12/#	97	137
		54.5" wide x 12" deep	AXM15/#	99	139
		66.25" wide x 12" deep	AXM18/#	114	160

*All shared desking shows pricing per pod.



Please note:
 Single sided desk cable management can be found on page 104

- Select Worksurface Finish

Worksurface
300
8232
7981
3201

LPL
HPL

Anwil Shared Desking

Product	Description	Worktop	Code	LPL*	HPL*
	Desk Double sided 2 User Cable trays	2 @ 48" x 24"	AN2DSD126/W#	1472	1678
		2 @ 48" x 30"	AN2DSD1275/W#	1667	1943
		2 @ 60" x 24"	AN2DSD156/W#	1625	1895
		2 @ 60" x 30"	AN2DSD1575/W#	1832	2158
		2 @ 72" x 24"	AN2DSD186/W#	1928	2176
		2 @ 72" x 30"	AN2DSD1875/W#	1996	2402
	Desk Double sided 4 User Cable trays	4 @ 48" x 24"	AN4DSD126/W#	2468	2880
		4 @ 48" x 30"	AN4DSD1275/W#	2787	3339
		4 @ 60" x 24"	AN4DSD156/W#	2844	3650
		4 @ 60" x 30"	AN4DSD1575/W#	3105	3757
		4 @ 72" x 24"	AN4DSD186/W#	3143	3639
		4 @ 72" x 30"	AN4DSD1875/W#	3437	4249
	Desk Double sided 6 User Cable trays	6 @ 48" x 24"	AN6DSD126/W#	3472	4090
		6 @ 48" x 30"	AN6DSD1275/W#	3876	4704
		6 @ 60" x 24"	AN6DSD156/W#	3956	4766
		6 @ 60" x 30"	AN6DSD1575/W#	4385	5363
		6 @ 72" x 24"	AN6DSD186/W#	4416	5160
		6 @ 72" x 30"	AN6DSD1875/W#	4875	6093

*All shared desking shows pricing per pod.

Please note:

Cable tray covers can be found on page 105



- Select Worksurface Finish

Worksurface

300	8232	7981	8201
LPL	HPL		

Anvil Shared Desking

With standard screens

Product	Description	Worktop	Code	LPL*	HPL*
	Desk Double sided 2 User Cable trays Spine screens	2 @ 48" x 24"	AN2DSD126/W##	1928	2134
		2 @ 48" x 30"	AN2DSD1275/W##	2085	2361
		2 @ 60" x 24"	AN2DSD156/W##	2197	2467
		2 @ 60" x 30"	AN2DSD1575/W##	2412	2738
		2 @ 72" x 24"	AN2DSD186/W##	2424	2672
		2 @ 72" x 30"	AN2DSD1875/W##	2658	3064
	Desk Double sided 4 User Cable trays Spine screens	4 @ 48" x 24"	AN4DSD126/W##	3445	3857
		4 @ 48" x 30"	AN4DSD1275/W##	3718	4270
		4 @ 60" x 24"	AN4DSD156/W##	3975	4515
		4 @ 60" x 30"	AN4DSD1575/W##	4302	4954
		4 @ 72" x 24"	AN4DSD186/W##	4488	4984
		4 @ 72" x 30"	AN4DSD1875/W##	4782	5594
	Desk Double sided 6 User Cable trays Spine screens	6 @ 48" x 24"	AN6DSD126/W##	4913	5531
		6 @ 48" x 30"	AN6DSD1275/W##	5254	6082
		6 @ 60" x 24"	AN6DSD156/W##	5770	6580
		6 @ 60" x 30"	AN6DSD1575/W##	5701	6679
		6 @ 72" x 24"	AN6DSD186/W##	6453	7197
		6 @ 72" x 30"	AN6DSD1875/W##	6925	8143

*All shared desking shows pricing per pod.

Please note:

Comseal covers can be found on page 104

- Select finishes

Worksurface



300
8232
7981
8201
+
Screen insert

I
B
T

LPL HPL
e-Panel
PVC

Anvil Shared Desking

With Devise screens

Product	Description	Worktop	Code	LPL*	HPL*
	Desk Double sided 2 User Cable trays Spine screens	2 @ 48" x 24"	AN2DSD126/W##	2168	2374
		2 @ 48" x 30"	AN2DSD1275/W##	2345	2621
		2 @ 60" x 24"	AN2DSD156/W##	2471	2741
		2 @ 60" x 30"	AN2DSD1575/W##	2713	3039
		2 @ 72" x 24"	AN2DSD186/W##	2727	2975
		2 @ 72" x 30"	AN2DSD1875/W##	2991	3397
	Desk Double sided 4 User Cable trays Spine screens	4 @ 48" x 24"	AN4DSD126/W##	3876	4288
		4 @ 48" x 30"	AN4DSD1275/W##	4183	4735
		4 @ 60" x 24"	AN4DSD156/W##	4472	5012
		4 @ 60" x 30"	AN4DSD1575/W##	4839	5491
		4 @ 72" x 24"	AN4DSD186/W##	5049	5545
		4 @ 72" x 30"	AN4DSD1875/W##	5379	6191
	Desk Double sided 6 User Cable trays Spine screens	6 @ 48" x 24"	AN6DSD126/W##	5526	6144
		6 @ 48" x 30"	AN6DSD1275/W##	5910	6738
		6 @ 60" x 24"	AN6DSD156/W##	6490	7300
		6 @ 60" x 30"	AN6DSD1575/W##	6413	7391
		6 @ 72" x 24"	AN6DSD186/W##	7259	8003
		6 @ 72" x 30"	AN6DSD1875/W##	7790	9008

*All shared desking shows pricing per pod.

Please note:







Eclipse tray covers can be found on page 89

- Select finishes

Worksurface
300
8232
7981
8201
 +
 E-Panel Color
DBL
DCH
DGR

LPL HPL

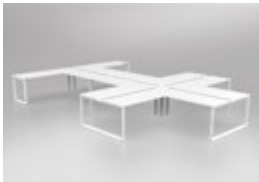
Anvil 90° Workstations

Product	Description	Worktop	Code	LPL*	HPL*
	90° Workstation 2 User	2 @ 72" x 72" x 24"	AN2U186186/W#	2095	2549
		2 @ 72" x 72" x 30"	AN2U187187/W#	2363	3045
	90° Workstation T layout 2 User Cable trays	2 @ 72" x 72" x 24"	AN2T186186/W#	2602	3056
		2 @ 72" x 72" x 30"	AN2T187187/W#	2905	3587
	90° Workstation Plus layout 4 User Cable trays	4 @ 72" x 72" x 24"	AN4P186186/W#	5609	6517
		4 @ 72" x 72" x 30"	AN4P187187/W#	6203	7567
	90° Workstation H layout 4 User Cable trays	4 @ 72" x 72" x 24"	AN4H186186/W#	4736	5644
		4 @ 72" x 72" x 30"	AN4H187187/W#	5247	6611
	90° Workstation 6 User Cable trays	6 @ 72" x 72" x 24"	AN6PT186186/W#	7762	9124
		6 @ 72" x 72" x 30"	AN6PT187187/W#	8541	10587
	90° Workstation Double plus layout 8 User Cable trays	8 @ 72" x 72" x 24"	AN8P186186/W#	10796	12612
		8 @ 72" x 72" x 30"	AN8P187187/W#	11852	14580

*All shared desking shows pricing per pod.

Please note:

Cable tray covers can be found on page 105



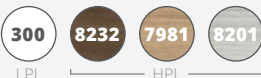

- Select Worksurface Finish

Worksurface



Anvil 90° Workstations

With standard screens

Product	Description	Worktop	Code	LPL*	HPL*
	90° Workstation T layout 2 User Spine screens Cable trays	2 @ 72" x 72" x 24"	AN2T186186/W##	3215	3669
		2 @ 72" x 72" x 30"	AN2T187187/W##	3584	4266
	90° Workstation Plus layout 4 User Spine screens Cable trays	4 @ 72" x 72" x 24"	AN4P186186/##	8151	9059
		4 @ 72" x 72" x 30"	AN4P187187/W##	8903	10267
	90° Workstation H layout 4 User Spine screens Cable trays	4 @ 72" x 72" x 24"	AN4H186186/W##	5700	6608
		4 @ 72" x 72" x 30"	AN4H187187/W##	6208	7572
	90° Workstation 6 User Spine screens Cable trays	6 @ 72" x 72" x 24"	AN6PT186186/W##	13835	15197
		6 @ 72" x 72" x 30"	AN6PT187187/W##	14670	16716
	90° Workstation Double plus layout 8 User Spine screens Cable trays	8 @ 72" x 72" x 24"	AN8P186186/W##	16261	18077
		8 @ 72" x 72" x 30"	AN8P187187/W##	17275	20003

*All shared desking shows pricing per pod.

Please note:

Comseal covers can be found on page 104

- Select finishes

Worksurface

300
8232
7981
8201
+
Screen insert

I
B
T

LPL
HPL
e-Panel
PVC

Anvil 90° Workstations

With Devise screens

Product	Description	Worktop	Code	LPL*	HPL*
	90° Workstation T layout 2 User Spine screens	2 @ 72" x 72" x 24"	AN2T186186/W##	3644	4098
	Cable trays	2 @ 72" x 72" x 30"	AN2T187187/W##	4049	4731
	90° Workstation Plus layout 4 User Spine screens	4 @ 72" x 72" x 24"	AN4P186186/W##	9226	10134
	Cable trays	4 @ 72" x 72" x 30"	AN4P187187/W##	10050	11414
	90° Workstation H layout 4 User Spine screens	4 @ 72" x 72" x 24"	AN4H186186/W##	6468	7376
	Cable trays	4 @ 72" x 72" x 30"	AN4H187187/W##	7017	8381
	90° Workstation 6 User Spine screens	6 @ 72" x 72" x 24"	AN6PT186186/W##	15648	17010
	Cable trays	6 @ 72" x 72" x 30"	AN6PT187187/W##	16555	18601
	90° Workstation Double plus layout 8 User Spine screens	8 @ 72" x 72" x 24"	AN8P186186/W##	18405	20221
	Cable trays	8 @ 72" x 72" x 30"	AN8P187187/W##	19502	22230

*All shared desking shows pricing per pod.

Please note:





Eclipse tray covers can be found on page 89

- Select finishes

Worksurface
300
8232
7981
8201
 + **E-Panel Color**
DBL
DCH
DGR

LPL
HPL

Anvil 120° Workstations

Product	Description	Worktop	Code	LPL*	HPL*
	120° Workstation 3 User Cable trays	3 @ 48" x 48" x 24"	AN3SW12126/W#	4195	5473
	120° Workstation 6 User Cable trays	6 @ 48" x 48" x 24"	AN6SW12126/W#	8390	10946
	120° Workstation 9 User Cable trays	9 @ 48" x 48" x 24"	AN9SW12126/W#	12585	16419
	120° Workstation 12 User Cable trays	12 @ 48" x 48" x 24"	AN12SW12126/W#	16780	21892
	120° Workstation 18 User Cable trays	18 @ 48" x 48" x 24"	AN18SW12126/W#	25170	32838





*All shared desking shows pricing per pod.

Please note:

Cable tray covers can be found on page 105



- Select Worksurface Finish

Worksurface

			
LPL		HPL	

Anvil 120° Workstations

With standard screens

Product	Description	Worktop	Code	LPL*	HPL*
	120° Workstation 3 User Cable trays Spine screens	3 @ 48" x 48" x 24"	AN3SW12126/W##	5195	6473
	120° Workstation 6 User Cable trays Spine screens	6 @ 48" x 48" x 24"	AN6SW12126/W##	10390	12946
	120° Workstation 9 User Cable trays Spine screens	9 @ 48" x 48" x 24"	AN9SW12126/W##	15584	19418
	120° Workstation 12 User Cable trays Spine screens	12 @ 48" x 48" x 24"	AN12SW12126/W##	20779	25891
	120° Workstation 18 User Cable trays Spine screens	18 @ 48" x 48" x 24"	AN18SW12126/W##	31168	38836

*All shared desking shows pricing per pod.

Please note:

Comseal covers can be found on page 104

- Select finishes

Worksurface
300
8232
7981
8201
+
Screen insert
I
B
T

LPL
HPL
e-Panel
PVC

Anvil 120° Workstations

With Devise screens

Product	Description	Worktop	Code	LPL*	HPL*
	120° Workstation 3 User Cable trays Spine screens	3 @ 48" x 48" x 24"	AN3SW12126/W##	5844	7122
	120° Workstation 6 User Cable trays Spine screens	6 @ 48" x 48" x 24"	AN6SW12126/W##	11688	14244
	120° Workstation 9 User Cable trays Spine screens	9 @ 48" x 48" x 24"	AN9SW12126/W##	17532	21366
	120° Workstation 12 User Cable trays Spine screens	12 @ 48" x 48" x 24"	AN12SW12126/W##	23376	28488
	120° Workstation 18 User Cable trays Spine screens	18 @ 48" x 48" x 24"	AN18SW12126/W##	35064	42732

*All shared desking shows pricing per pod.

Please note:

Eclipse tray covers can be found on page 89

- Select finishes

Worksurface 300 8232 7981 8201 + **E-Panel Color** DBL DCH DGR

LPL HPL

Standard Desk Hung Screens

Product	Description	Dimensions	Code	CAD
	Desk hung screen	48" x 36" high	AXHS12OFF/#	565
		60" x 36" high	AXHS15OFF/#	733
		72" x 36" high	AXHS18OFF/#	778
		48" x 36" high	AXHS12/#	530
		60" x 36" high	AXHS15/#	700
		72" x 36" high	AXHS18/#	746

Please note:

Offset Bracket code (OFF) is for screens used on single sided Anvil Straightline workstations.

- Select screen insert

E-panel



OR

Translucent



Devise Desk Hung Screens

Product	Description	Dimensions	Code	CAD
	Desk hung screen	48" x 36" high	DHS48OFF/#	788
		60" x 36" high	DHS60OFF/#	635
		72" x 36" high	DHS72OFF/#	875
		48" x 36" high	DHS48/#	597
		60" x 36" high	DHS60/#	839
		72" x 36" high	DHS72/#	825

Please note:

Offset Bracket code (OFF) is for screens used on single sided Anvil Straightline workstations.

- Select Screen Colour



E-panel



Standard Return Screens

Product	Description	Dimensions	Code	CAD
	Return screen Single sided desks	23" x 20" high	AXSRS58/#	200
		29" x 20" high	AXSRS73/#	221
	Return screen Double sided desks	26" x 20" high	AXRS65/#	186
		32" x 20" high	AXRS80/#	219
	Return screen Double sided desks end of run	26" x 20" high	AXRS65/#_E	201
		32" x 20" high	AXRS80/#_E	236

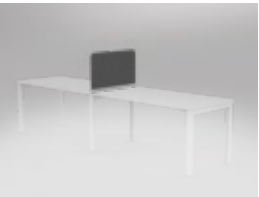
Devise Return Screens

Product	Description	Dimensions	Code	CAD
	Return screen Single and double sided desks	23" x 12" high	DRS5931/#	185
		29" x 12" high	DRS7431/#	218
	Return screen Single and double sided desks	23" x 18" high	DRS5946/#	225
		29" x 18" high	DRS7446/#	248

- Select Standard screen insert

E-panel



OR

Translucent







- Select Devise Screen Colour

E-panel



Anwil Electrical

Product	Description	Dimensions	Code	CAD
	Voltra power module 3 outlets 2 USB-A 108" cord		AXPM3O2U-W-108	228
	One Duplex For one duplex in tray		ELECTRICAL_1	247
	Two Duplex For two duplexes in tray		ELECTRICAL_2	450
	Base Infeed Hardwire	Standard - 72"	EHINFD-72	272
	Ceiling Infeed Hardwire	Standard - 144"	EHINFD-144	326

Accessories

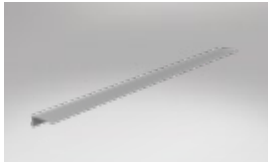
Product	Description	Dimensions	Code	CAD
	Eclipse Tray Tidy Flexible PVC tray cover	48"	ECTT48	75
		60"	ECTT60	92
		72"	ECTT72	109

Please note:

- All electrical prices include all required jumper cables, connecting hardware, duplexes, electrical face plate, and data face plate with four knockouts
- Single-sided desks can only have below desk electrical, and double sided desks can only have above desk electrical.





Receptions & Storage

Reception Counters	94
Mobiles	95
Caddy Mobiles	96
Storage Towers	97
Overhead Storage	97
Storage.....	98
Worktops.....	99

Reception Counters

Product	Description	Dimensions	Code	CAD
	Axis reception Pop-top Fits over desk - AXSD1875/# - AX9W181875/#	72.5" wide x 42" high x 12" deep	AXRPD183/W	787
	Axis reception corner Pop-top Fits over workstation - AX9W181875/#	72.5" x 75" x 42" high x 12" deep <i>Can be left hand or right hand</i>	AXRPW18183/W	1453
	Axis reception Fits over desk - AXSD1875/# - AX9W181875/#	72.5" wide x 38.5" high x 12" deep	AXRD183/W	563
	Axis reception corner Fits over workstation - AX9W181875/#	72.5" x 75" x 38.5" high x 12" deep <i>Can be left hand or right hand</i>	AXRW18183/W	1031
	Anvil reception - White Fits over desk - AXSD1875/#	73"-96" wide x 37" deep x 42" high	ANRC/WW	1851
	Anvil reception - Silver Fits over desk - AXSD1875/#	73"-96" wide x 37" deep x 42" high	ANRC/WS	1851
	Anvil Facade Upgrade	38.5" wide x 15" deep x 42" high	ANRFD/#	997

Please note:





Reception units require the desk to be ordered separately.

- Select Facade Upgrade Finish

Worksurface



Mobiles

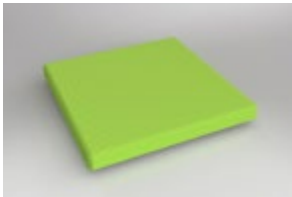
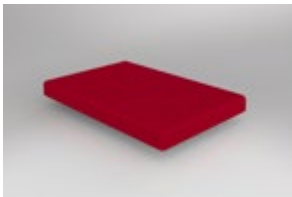





Product	Description	Dimensions	Code	CAD
	Mobile BBF - White Two box drawers One file drawer Gang locking	25.2"H x 16.0"W x 18.6"D	AXM2F/W	692
	Mobile BBF - Black Two box drawers One file drawer Gang locking	25.2"H x 16.0"W x 18.6"D	AXM2F/B	692
	Mobile BF - White One box drawer One file drawer Gang locking	20.5"H x 12.0"W x 18.6"D	AXM1F/W	540
	Mobile BF - Black One box drawer One file drawer Gang locking	20.5"H x 12.0"W x 18.6"D	AXM1F/B	540
	Toppa pad - large Breathe Upholstery	1.0"H x 16.0"W x 18.6"D <i>Does not fit BF mobile pedestal</i>	AXMTOPPA/#	77
	Toppa pad - small Breathe Upholstery	1.0"H x 12.0"W x 18.6"D <i>Does not fit BBF mobile pedestal</i>	AXBFTOPPA-US/#	77

- Select fabric - Toppa pad

Breathe



Caddy Mobiles



Product	Description	Dimensions	Code	CAD
	Bookcases	25.2"H x 34.5"W x 18.1"D	AXCMB/W	554
	Bookcase & drawer	25.2"H x 34.5"W x 18.1"D <i>Can be left hand or right hand</i>	AXCM1/W	1152
	Drawers	25.2"H x 34.5"W x 18.1"D	AXCM2/W	1753
	Bookcase & tambour	25.2"H x 34.5"W x 18.1"D <i>Can be left hand or right hand</i>	AXCMT1/W	1064
	Drawer & tambour	25.2"H x 34.5"W x 18.1"D <i>Can be left hand or right hand</i>	AXCMTD/W	1666
	Tambours	25.2"H x 34.5"W x 18.1"D	AXCMT2/W	1577
	Toppa pad Breathe Upholstery	1.0"H x 16.0"W x 18.6"D	AXMTOPPA/#	77

- Select fabric - Toppa pad

Breathe









Storage Towers

Product	Description	Dimensions	Code	CAD
	Bookcase Adjustable shelves	49.2"H x 17.7"W x 18.5"D	AXBST12/W	581
	Bookcase & drawers Adjustable shelves	49.2"H x 17.7"W x 18.5"D	AXBSTD12/W	1181
	Bookcase & tambour Adjustable shelves	49.2"H x 17.7"W x 18.5"D	AXBSTT12/W	1092







Overhead Storage

Product	Description	Dimensions	Code	CAD
	Wall-mount hutch 4 locking doors	47.25" W x 16.9"H x 14"D	AX12WMH4D/W	1160

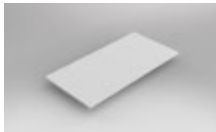
Storage

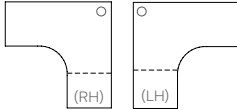
Product	Description	Dimensions	Code	CAD
	Bookcase 3 Level	49.2"H x 35.4"W x 11.8"D	AXB12/W	694
	Cupboard 3 Level Locking	49.2"H x 35.4"W x 15.7"D	AXC12/W	938
	Credenza 2 Level Locking	35.4"H x 70.9"W x 15.7"D	AXCZ18/W	1319
	Lateral file 2 drawer Locking	28.7"H x 35.4"W x 23.6"D	AXLF2/W	1380
	Tambour 3 Level Locking	41.3"H x 35.4"W x 17.7"D	AXT12/W	1296
	Upgrade Tambour planter box <i>Plants not included</i>	7.9"H x 35.4"W x 17.7"D	AXPBOX/W	190
	Desk mount shelf 4 x chrome hoops	9.6"H x 23.6"W x 11.8"D	AXDSH6/W	191

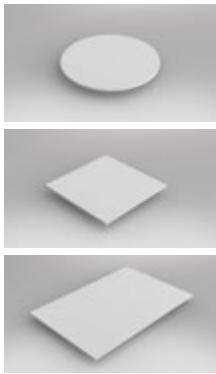
Worktops

Product	Description	Dimensions	Code	LPL	HPL
	Desk	36" x 24"	AXSD096/#__T	129	193
		48" x 24"	AXSD126/#__T	186	289
		48" x 30"	AXSD1275/#__T	223	361
		60" x 24"	AXSD156/#__T	226	361
		60" x 30"	AXSD1575/#__T	277	440
		72" x 24"	AXSD186/#__T	269	393
		72" x 30"	AXSD1875/#__T	325	528
		72" x 36"	AXSD189/#__T	330	580
	90° Workstation 	72" x 72"/24" (Right Hand Join)	AX9W18186/WR__T	567	
		72" x 72"/24" (Left Hand Join)	AX9W18186/WL__T	567	
		72" x 72"/30" (Right Hand Join)	AX9W181875/WR__T	610	
		72" x 72"/30" (Left Hand Join)	AX9W181875/WL__T	610	
	120° Workstation	48" x 48"/24"	AX12W12126/#__T	573	989
	Meeting table	36" diameter	AXT900R/#__T	193	286
		42" diameter	AXT105R/#__T	256	421
		60" diameter	AXT150R/#__T	549	807
		24" x 24"	AXSD066/#__T	100	125
		39" x 39"	AXT1010/#__T	236	475
		60" x 48"	AXT1512/#__T	452	739
		72" x 48"	AXT1812/#__T	472	776
		95" x 48"	AXT2412/#__T	589	1086
			Meeting table With cutout for power modules	72" x 48"	AXT1812/#__T-1C
96" x 48"	AXT2412/#__T-1C			589	1086

- Select Worksurface Finish

Worksurface **300** **8232** **7981** **8201**

LPL HPL







Mobile Dividers

Orbit Divider..... 102





Orbit Divider

Product	Description	Dimensions	Code	CAD
	Mobile Divider Whiteboard Locking casters	60" x 36"	ODM6036/WB	1411
	Mobile Divider Pixel design Locking casters	60" x 36"	ODMPXL6036/GYW	2275

THIS PAGE IS INTENTIONALLY
LEFT BLANK

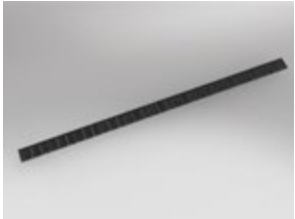

Cable Management

Product	Description	Dimensions	Code	CAD
	Single-sided cable tray Power/data segregation Side fixing to Axis/Anvil horizontal support rail	42.5" Length	AXCTS11/#	117
		54.3" Length	AXCTS14/#	154
		66.1" Length	AXCTS17/#	183
	Single-sided cable tray Power/data segregation Top Lip Fixing	42.5" Length	AXCTT11/#	117
		54.3" Length	AXCTT14/#	154
		66.1" Length	AXCTT17/#	183
	Cable Cobra White Power/data segregation	42.5" Length	CABCOBRA/@	87
	Cable Clutch White Power/data segregation	Set of 5	CABCLUTCH_W	44
	Comseal cable tidy brushes	46.5" for 48" workstation	ANCS12/B	65
		58.5" for 60" workstation	ANCS15/B	79
		70.3" for 72" workstation	ANCS18/B	95

- Select finish



@ - Select finish



Cable Tray Covers

Product	Description	Dimensions	Code	LPL	HPL
	Cable tray covers	Fits 48" Desk with Twin Power	AXT450125/#	188	238
		Fits 60" Desk with Twin Power	AXT600125/#	194	258
		Fits 72" Desk with Twin Power	AXT750125/#	204	272
		Fits 48" Desk with Quad Power	AXT407125/#	188	238
		Fits 60" Desk with Quad Power	AXT557125/#	194	246
		Fits 72" Desk with Quad Power	AXT707125/#	204	270

*Pricing is shown per pair.

Please note:





All cable tray covers include necessary hardware.

- Select Worksurface Finish

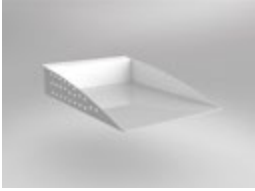

Worksurface 300 8232 7981 3201

LPL HPL



Accessories & Components

Product	Description	Dimensions	Code	CAD
	Paper tray Rail hung White		AXA4TRAY/W	40
	Pen holder Rail hung White		AXPENTRAY/W	20
	Deskmount shelf brackets		AXDSHB/W	42
	E-panel screen brackets	A For double sided desk	ESCRCLAMPDS/W	39
		B For single sided desk	ESCRCLAMPT/W	31
		C For single sided desk	ESCRCLAMPSS/W	38
	Keys and locks	Axis system master key	AXKEY	9
		Axis system master key for barrel removal	AXKEYB	11
		Axis system keyed alike barrel and key	AXBARRELM	11
			AXBARRELC	17

Monitor Arms

Product	Description	Dimensions	Code	CAD
	Fulcrum Dual Gas spring arms Grab Handle Black	Accommodates 17" - 32" screen	FCDMA/B	477
	Fulcrum Single Gas spring arms Desk mount Black	Accommodates 17" - 49" screen	FCSMA/B	308
	Single monitor arm Desk mount Black	Accommodates 13" - 27" screen	FWMA1/B	225

Planter Wall

Product	Description	Dimensions	Code	CAD
	Viro Wall Frame only	78" x 40" x 8"	PLANTER/B	2223
	Pots		PLANTERPOT/B	32



General - 10 Year

Axis Desking, side & conference tables, receptions, storage; Anvil Desking, receptions, storage; Agile desking; Modulus training & conference tables; Uni training tables

All Workspace48 products are durable for long-term performance and value. Our products have been rigorously tested to the equivalent of 10 years average use, and our processes comply with internationally recognized certifications. We know the peace of mind a warranty like this can give when making a purchase. If you need to know any information about the legal terms of your warranty, you can find everything right here, or simply give one of our friendly account managers a call.

The 10 Year Warranty is valid on orders placed on or after January 1, 2020.

Warranty

Workspace48 promises the original purchaser that it will repair or replace with the comparable product, at its option and free of charge (for material and components) any product, part or component which fails under normal use over the duration of specified warranty term (taken from the date of purchase).

Normal commercial usage is defined as the equivalent of a single shift, 40-hour work week.

A Customer who requests services under this warranty must comply with directions from Workspace48 staff if the warranty claim is to be investigated, and if Workspace48 is to provide repairs and/or spare parts and/or replacement solutions (where applicable). The Customer will usually be required to provide a detailed description of the warranty service they are requesting, accompanied by any relevant photos or videos.

If the Customer does not comply with the directions aforementioned, Workspace48 is not required to provide services in accordance with this warranty. Without the description and images, Workspace48 can neither investigate the claim nor provide an appropriate solution.

Goods purchased from Workspace48 are covered by guarantees that cannot be excluded under Canadian Consumer Law. The Customer is entitled to a replacement or refund in a case of major fault.

Minor variations in dimensions, color, grain, or finish in Goods received by a Customer, when compared with images or descriptions on the Website, are not covered by this Warranty. The Warranty does not cover damage that affects only packaging.

Warranty Limitations

The particular product lines, materials and components listed below are covered according to the following schedule from the date of sale:

- Five Years - Electric motors, workstation electrical components

Warranty Exclusions

This warranty does not apply, and no other warranty applies to:

- Products that were not installed, used, or maintained in accordance with Workspace48 instructions
- Products that have been disassembled, modified, or rebuilt
- Normal wear and tear, which is to be expected over the course of ownership
- High-wear items such as glides and textiles
- Abuse, misuse, or accident
- Alteration or modification of the product including substitution of Workspace48 components with any unauthorized non-Workspace48 components
- Products considered consumables, Customer's Own Material (COM) or non-standard textiles and materials
- Variations occurring in surface materials (e.g., color-fastness or matching grains, textures, and colors across dissimilar lots)
- Products used for rental purposes

To the extent allowed by law, Workspace48 makes no other warranty, either express or implied, including any warranty of merchantability or fitness for a particular purpose. Workspace48 will not be liable for any consequential or incidental damages.



Seating - 10 Year

Adapta, Balance Executive, Balance Task, Balance Guest, Balance Training, Game, Metro, Mode, Otto, Politan

All Workspace48 products are durable for long-term performance and value. Our products have been rigorously tested to the equivalent of 10 years average use, and our processes comply with internationally recognized certifications. We know the peace of mind a warranty like this can give when making a purchase. If you need to know any information about the legal terms of your warranty, you can find everything right here, or simply give one of our friendly account managers a call.

The 10 Year Warranty is valid on orders placed on or after January 1, 2020.

Warranty

Workspace48 promises the original purchaser that it will repair or replace with the comparable product, at its option and free of charge (for material and components) any product, part or component which fails under normal use over the duration of specified warranty term (taken from the date of purchase).

Normal commercial usage is defined as the equivalent of a single shift, 40-hour work week.

A Customer who requests services under this warranty must comply with directions from Workspace48 staff if the warranty claim is to be investigated, and if Workspace48 is to provide repairs and/or spare parts and/or replacement solutions (where applicable). The Customer will usually be required to provide a detailed description of the warranty service they are requesting, accompanied by any relevant photos or videos.

If the Customer does not comply with the directions aforementioned, Workspace48 is not required to provide services in accordance with this warranty. Without the description and images, Workspace48 can neither investigate the claim nor provide an appropriate solution.

Goods purchased from Workspace48 are covered by guarantees that cannot be excluded under Canadian Consumer Law. The Customer is entitled to a replacement or refund in a case of major fault.

Minor variations in dimensions, color, grain, or finish in Goods received by a Customer, when compared with images or descriptions on the Website, are not covered by this Warranty. The Warranty does not cover damage that affects only packaging.

Warranty Limitations

The particular product lines, materials and components listed below are covered according to the following schedule from the date of sale:

- Five Years - Link and Luna chairs

Warranty Exclusions

This warranty does not apply, and no other warranty applies to:

- Products that were not installed, used, or maintained in accordance with Workspace48 instructions
- Products that have been disassembled, modified, or rebuilt
- Normal wear and tear, which is to be expected over the course of ownership
- High-wear items such as glides and textiles
- Abuse, misuse, or accident
- Alteration or modification of the product including substitution of Workspace48 components with any unauthorized non-Workspace48 components
- Products considered consumables, Customer's Own Material (COM) or non-standard textiles and materials
- Variations occurring in surface materials (e.g., color-fastness or matching grains, textures, and colors across dissimilar lots)
- Products used for rental purposes

To the extent allowed by law, Workspace48 makes no other warranty, either express or implied, including any warranty of merchantability or fitness for a particular purpose. Workspace48 will not be liable for any consequential or incidental damages.

Dealer Freight Schedule

ZONE 1 - Transit time: 1-3 days	ZONE 2 - Transit time: 3-4 days	ZONE 3 - Transit time: 3-5 days	ZONE 4 - Transit time: 3-5 days	ZONE 5 - Transit time: 4-8 days
<i>** Pricing tiers below shown in NET pricing</i>				
Minimum - \$125	Minimum - \$195	Minimum - \$195	Minimum - \$175	Minimum - \$205
\$0 - \$5,000: 6% of NET	\$0 - \$5,000: 14% of NET	\$0 - \$5,000: 17% of NET	\$0 - \$5,000: 12% of NET	\$0 - \$5,000: 18% of NET
\$5,000 - \$10,000: 4% of NET	\$5,000 - \$10,000: 12% of NET	\$5,000 - \$10,000: 15% of NET	\$5,000 - \$10,000: 11% of NET	\$5,000 - \$10,000: 16% of NET
\$10,000 - \$30,000: 3% of NET	\$10,000 - \$30,000: 8% of NET	\$10,000 - \$30,000: 10% of NET	\$10,000 - \$30,000: 10% of NET	\$10,000 - \$30,000: 11% of NET
\$30,000 - \$100,000: 2% of NET	\$30,000 - \$100,000: 7% of NET	\$30,000 - \$100,000: 9% of NET	\$30,000 - \$100,000: 9% of NET	\$30,000 - \$100,000: 10% of NET
\$100,000+: FREE	\$100,000+: 3% of NET	\$100,000+: 5% of NET	\$100,000+: 1% of NET	\$100,000+: 5% of NET
Quebec	Manitoba	Alberta	Prince Edward Island	Newfoundland & Labrador
Ontario	Saskatchewan	British Columbia	Nova Scotia	
<i>** Free freight on orders over \$3000 NET shipping to GTA and London Area</i>			New Brunswick	

- Price ranges are shown as NET prices
- Modulus conference tables may have an additional \$100 freight charge. Please request freight quote per order
- Freight structures are based only on stock draw projects; container projects are quoted separately
- Freight schedules are subject to change every six months
- Freight rates are applicable to carriers and transit times selected by WORKSPACE48. Special requests may result in additional charges
- Freight rates are to metropolitan areas; shipments to all other areas may have additional charges
- Freight rates are per shipment, not per order. If two shipments are required, two freight charges will be applied.
- Workspace48 does not arrange shipping to the USA for orders sold through Canadian dealers.

Terms & Conditions

1. These terms and conditions shall apply to all sales of goods by Workspace48 Inc. No variation of any of these conditions shall be binding unless expressly agreed to by Workspace48 Inc. in writing.
2. All prices are exclusive of GST/HST unless otherwise stated.
3. All orders under \$3,000 net will be subject to a \$33 NET packaging fee.
4. Payment in full shall be made to Workspace48 Inc. net 30 days on invoice. All orders over \$50,000 require a 35% deposit. Container payment terms are 30% deposit with order, 70% upon arrival of product. Workspace48 Inc. reserves the right to demand payment before that date or in advance and further reserves the right to specify in any quotation a requirement for a deposit to be paid before work shall commence. Interest shall be payable to Workspace48 Inc. on the Customer's overdue accounts at the rate of 18% per annum calculated on a daily basis to run from the due date for payment until receipt by Workspace48 Inc. of the full amount payable. The Customer shall pay all costs including any legal costs incurred in recovering overdue accounts.
5. We may suspend or terminate this agreement if at any time we consider the Customer's credit worthiness to be unsatisfactory for any reason or if the Customer is in default of any of its payment or other obligations hereunder. We shall not be responsible under any circumstances for any loss, damages, costs or expenses whatsoever caused in any way by the suspension or termination under this clause.
6. Goods returned for credit will only be accepted subject to Workspace48 Inc.'s prior agreement in writing with all freight charges prepaid by the Customer. Returned goods, if accepted by Workspace48 Inc., are subject to a minimum restocking fee of the greater of \$75 or 20% of the invoice price. Returned product will not be accepted if it has been removed from its original packaging and no credit will be issued for product returned damaged.
7. Prices are subject to variation without notice, and goods and services will be invoiced at prices current at the time of their provision unless otherwise agreed in writing.
8. Sales tax and any other taxes or duty on or in respect of the goods sold by Workspace48 Inc. imposed by any Provincial or Federal Government law shall be payable by the Customer, but if those taxes or duties by law are or become payable by Workspace48 Inc., the prices in respect of the goods shall be increased by the amount necessary to ensure that the net amount actually received by Workspace48 Inc. is as if those taxes or duties were not payable.
9. If the Customer is a limited liability company or a trust, then the director(s) and shareholder(s) of the company or the trustee(s) of the trust (as the case requires), hereby guarantee the performance of the Customer's obligations under this agreement and are personally liable to meet the Customer's obligations under this agreement in the event of the Customer's default. Those director(s) and shareholder(s) or trustee(s) also agree to indemnify Workspace48 Inc. and hold Workspace48 Inc. harmless for any losses Workspace48 Inc. sustains as a result of the Customer's act or omission. A

- director, shareholder or trustee (as the case requires) must reimburse Workspace48 Inc. for all its losses caused by the Customer's act or omission within 21 days of Workspace Inc. making a demand for such reimbursement (time being of the essence). Any director, shareholder or trustee signing this agreement on behalf of the Customer also signs in a personal capacity for the purposes of the guarantee and indemnity contained in this clause.
10. The Customer warrants that such plans, specifications, measurements or information that have been supplied by the Customer at the time of commencing work on purpose built furniture are correct and can be relied upon. Once work has started the Customer may not vary or withdraw from this or any other agreement with Workspace48 Inc. unless with Workspace48 Inc.'s agreement in writing.
 11. All warranties conditions and representations whether express or implied other than any express warranty stated by Workspace48 Inc. in writing are hereby expressly negated and excluded except in circumstances where Workspace48 Inc. is by law unable to exclude or limit its liability. Provided that where the Customer is a consumer for the purpose of the Trade Practices Act, but the goods or services are not of a kind ordinarily required for personal domestic or household use or consumption, the liability of Workspace48 Inc. shall be limited as determined by Workspace48 Inc. to anyone or more of the following:
 - a. The replacement of the goods or the supply of equivalent goods
 - b. The payment of the costs of replacing the goods or of acquiring equivalent goods
 12. No claim of any nature whatsoever (other than relating to warranty) will be recognised unless made within 24 hours of delivery. All freight costs involved in returning goods must be paid by the Customer. A copy of the invoice evidencing sale to the Customer is to be included with the goods, and include photo's to clearly identify the issue concerned.
 13. Subject to everything in these conditions Workspace48 Inc. makes no further condition, warranty or representation, whether express or implied, written or oral in respect of the goods or services.
 14. Notwithstanding anything above Workspace48 Inc. shall not be liable for any consequential or indirect losses expenses or damages suffered by the Customer in consequence of any defect in materials or workmanship of the goods.
 15. Claims for errors, short supply, or for goods arriving in a damaged condition shall be made within seven (7) days of the date of invoice, and the Customer shall refuse to sign any deliver docket where goods arrive in a damaged condition. Workspace48 Inc. must be notified of the claim within 24 hours and assigned a file number by Workspace48 Inc. or the claim will not be accepted. The Customer is deemed to have accepted the goods unless it makes a claim under this clause. The Customer acknowledges that a signed delivery docket signifies acceptance that the goods arrived in an undamaged state and Workspace48 Inc. shall not be liable to repair any damage in such cases. The Customer is responsible to file any claim resulting from Customers' carrier.
 16. Risk in goods supplied under this agreement passes to the Customer upon delivery to the Customer or its agent or upon possession of the goods by the Customer or its agent, whichever is the earlier.
 17. Workspace48 Inc. shall not be liable in any way whatsoever for any failure to deliver any order on time or for non-delivery or delay caused directly or indirectly by war, act of God, strike, lockout, riot, Government action or interference, fire, earthquake, material, shortage, late delivery by manufacturers, shipping or transport delay or any other cause beyond the reasonable control of Workspace48 Inc. The Customer shall be bound to accept and pay for goods delivered within a reasonable time after such cause for the failure or delay on the part of Workspace48 Inc. has ceased to operate.
 18. To the fullest extent possible, ownership of any goods supplied by Workspace48 Inc. is retained by Workspace48 Inc. until payment in full is made for the goods supplied and for all other goods supplied by Workspace48 Inc. to the Customer. This clause creates a security interest under the Personal Property Securities Act 2009 in favour of Workspace48 Inc. in all present and after-acquired property supplied by Workspace48 Inc. to the Customer. Customers waive the right to be notified in writing of registration on the Personal Property Securities Register.
 19. Workspace48 Inc., its servants or its agents may immediately without giving the Customer any notice or waiting any time, retake possession of the goods supplied or any other goods supplied by Workspace48 Inc. under any other arrangement under which title in those goods is still maintained by Workspace48 Inc.
 20. The Customer gives Workspace48 Inc. authority for its servants and agents to enter and remain upon any land or premises where in Workspace48 Inc.'s opinion Workspace48 Inc.'s goods may be stored and take possession of the said goods.
 21. Under no circumstances shall Workspace48 Inc. be liable for any damage, costs, losses or expenses arising on or resulting from such repossession.
 22. The Customer shall hold the proceeds of sales of our goods arising in the normal course of trade, upon trust for Workspace48 Inc. and shall promptly account to Workspace48 Inc. for such proceeds or the amount of them necessary to pay all amounts due to Workspace48 Inc.
 23. The failure on the part of Workspace48 Inc. to exercise and enforce any rights conferred by this agreement shall not be deemed to be a waiver of any such right nor operate so as to bar the exercise or enforcement thereof at any time or times thereafter.
 24. All freight charges are as described in your company specific discount structure, unless otherwise specified on a project specific quotation.
 25. Upon receipt of an approved credit application, orders can be placed in the following way; Phone: 416 441 9898; Email: Orders@workspace48.com. Phone orders are required to have final confirmation in writing. All orders will be acknowledged by email as final confirmation of your order, including net pricing and quantities. If in the unlikely event of low stock, you will be notified and alternative solutions advised.
 26. In-stock items can be cancelled by the Customer in writing prior to dispatch, without any cancellation charge. Orders cancelled after shipping and before arrival to the Customer will be subject to a minimum handling fee of \$75 plus any applicable direct costs, payable by the Customer. Any custom built products are not able to be cancelled once the order has been acknowledged and entered into production.

Our Vision

**REVOLUTIONIZING THE WAY OFFICE
FURNITURE IS BOUGHT AND SOLD.**



E info@workspace48.com | P 416 441 9898